

PLASTIC MUDGUARD

PARAFANGO IN PLASTICA

ALETA DE PLASTICO

KOTFLÜGEL AUS KUNSTSTOFF

AILE PLASTIQUE

D20100

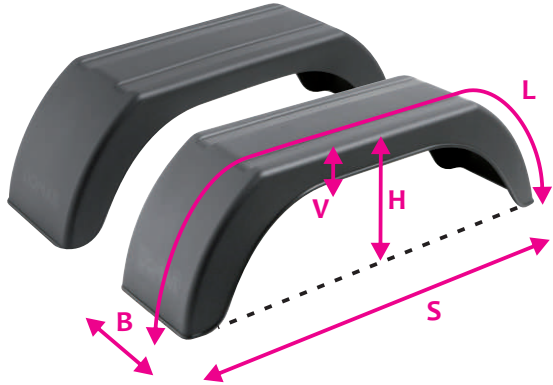

D20122

D20130



D20110



D20200

D20210



COD	B	S	H	L	V
D20100	160	550	175	735	40
D20110	180	610	245	890	70
D20122	200	770	330	1135	55
D20130	220	790	370	1210	55
D20200	200	700	370	1150	50
D20210	365	700	370	1150	50

PLASTIC HALF WING

CURVA PARAFANGO IN PLASTICA

ALETA DE PLASTICO

VIERTELSCHALE AUS KUNSTSTOFF

DEMI AILE, PLASTIQUE



COD	B	S	H	L	V
D10102	200	385	325	110	55
D10110	220	395	360	135	55

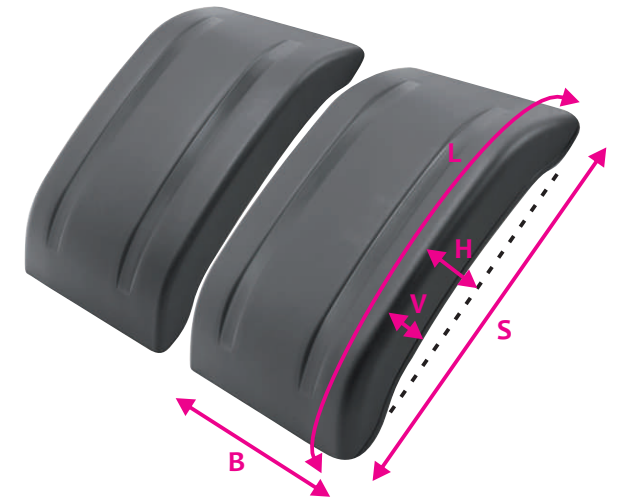

COD	B	S	H	L	V
D10200	280	460	90	500	60

PLASTIC TANDEM MUDGUARD

PARAFANGO TANDEM IN PLASTICA
 GUARDABARRO TANDEM PLASTICO
 TANDEM KOTFLÜGEL AUS KUNSTSTOFF
 GARDEBOUE TANDEM EN PLASTIQUE

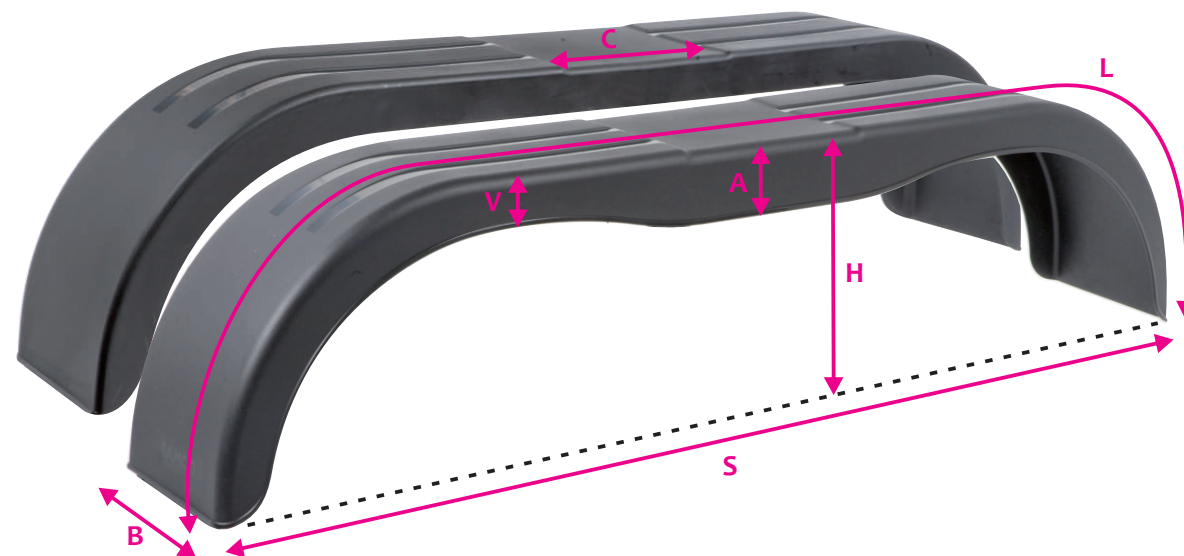
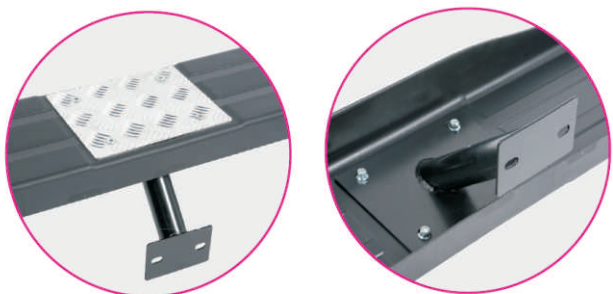

NEW PRODUCT

COD	B	S	H	L	V	A	C
D20250	220	1500	350	1910	60	90	250
D20300	240	1500	350	1910	60	90	250

BLACK COATED STAY

TUBO DRITTO VERNICIATO NERO
 SOPORTE ALETA NEGRO
 TRAGROHR GERADE SCHWARZ LACK
 TUBE DROIT PEINTURE NOIRE

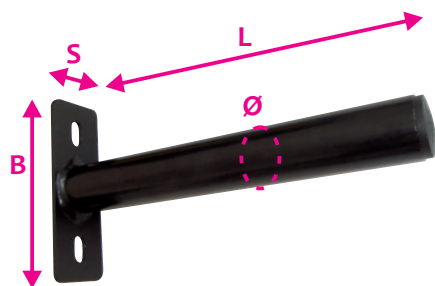

COD	B	S	L	Ø
D51100	130	45	450	33

PLASTIC SUPPORT FOR MUDGUARD

SUPPORTO PARAFANGO FISSO
 BRIDA DE SOPORTE ALETA FIJA
 TRÄGER FÜR KOTFLÜGEL
 SUPPORT FIX POUR AILE

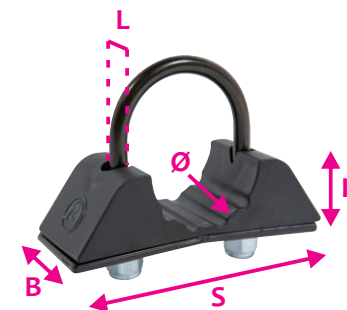

COD	B	S	H	Ø	L
D50140	30	78	22	34	M6
D50150	30	78	22	34	M8

TREAD PLATE ALUMINUM MUDGUARD

PARAFANGO IN ALLUMINIO MANDORLATO LATI ARROTONDATI

GUARDABARRO ALUMINIO ALMENDRADO

ALU RIFFELBLECH KOTFLÜGEL

AILE EN ALUMINIUM LARMÉ, CÔTÉS ARRONDIS

NEW PRODUCT
NEW PRODUCT

SINGLE AXLE
SINGLE AXLE

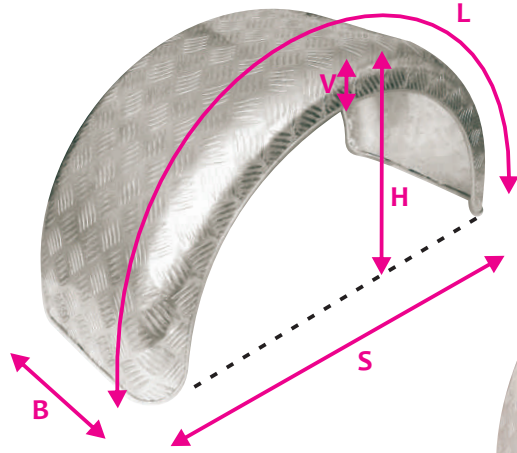

MULTI AXLE
MULTI AXLE



WITH EDGE		B	S	H	L	V	AXLE
D29102	D29122	200	770	385	1210	60	SINGLE AXLE
D29106	D29130	220	790	395	1240	60	SINGLE AXLE
D29110	D29250	220	1500	350	1910	60	MULTI AXLE
D29114	D29300	240	1500	350	1910	60	MULTI AXLE
D29118	D29400	220	2550	375	3000	60	MULTI AXLE



WITH WEDGE EDGE
WITH WEDGE EDGE

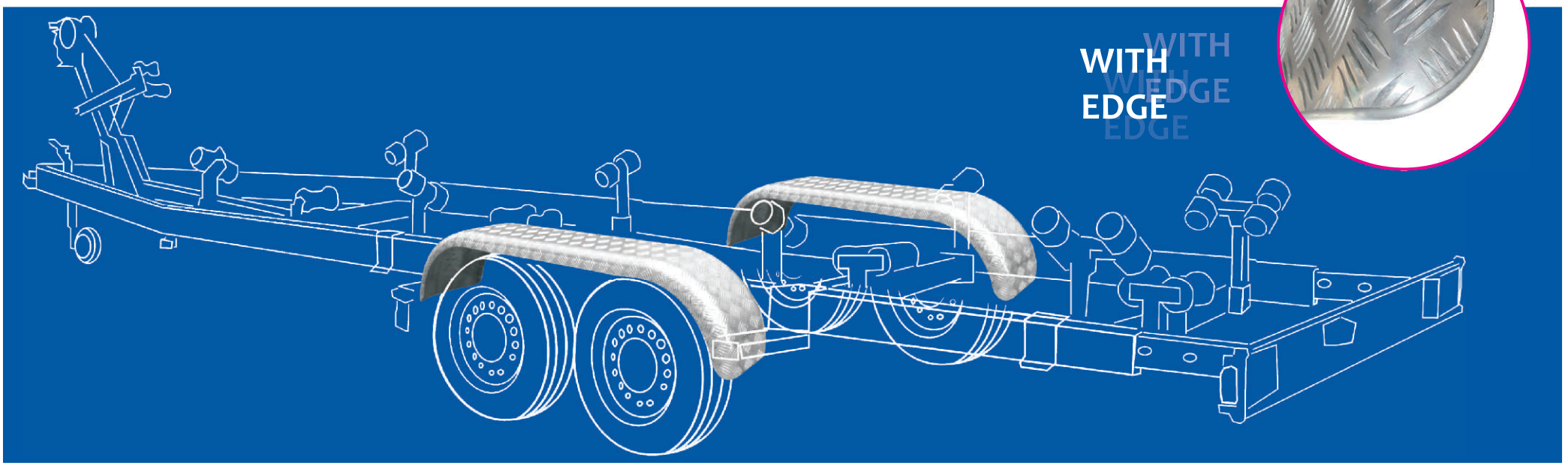

MUD FLAP NO LOGO

PARASPRUZZO NEUTRO STAMPATO
FALDILLA SIN LOGOTIPO
SPRITZLAPPE NEUTRAL
BAVETTE NEUTRE



DETAIL
DETAIL



COD	B	H	C
D52100	200	225	95
D52200	260	200	90

PLASTIC WHEEL CHOCK

CUNEO D'ARRESTO IN PLASTICA NERA
CUNA EN PALSTICO NEGRO
UNTERLEGKEIL AUS KUNSTSTOFF SCHWARZ
CALLE DE ROUE EN PLASTIQUE NOIRE

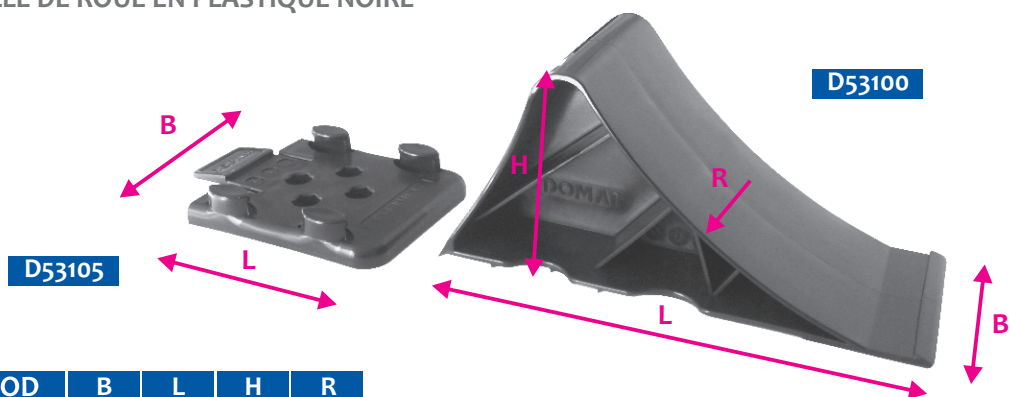

COD	B	L	H	R
D53100	90	225	100	250
D53105	104	140		

HOLDER FOR WHEEL CHOCK IN BLACK PLASTIC

SUPPORTO PER CUNEO IN PLASTICA NERA
SOPORTE PARA CUNA EN PALSTICO NEGRO
HALTERUNG FUER UNTERLEGKEIL AUS KUNSTSTOFF SCHWARZ
SUPPORT POUR CALLE DE ROUE EN PLASTIQUE NOIRE

ACCESSORIES FOR BOAT TRAILERS

ACCESSORI PER CARRELLI NAUTICI
ACCESORIOS PARA REMOLQUES NAUTICOS
ZUBEHÖRE FÜR BOOTSANHÄNGER
ACCESSOIRES POUR REMORQUES NAUTIQUES

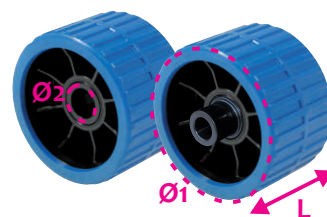

WOBBLE ROLLER

RULLO LATERALE FLOTTANTE
RODILLO LATERAL
KIELROLLE FLOTTIEREND
GALET

COD	L	Ø1	Ø2
D40100	74	120	15
D40101	74	120	15 *
D40102	74	120	21
D40103	74	120	21 *
D40104	74	120	26,5

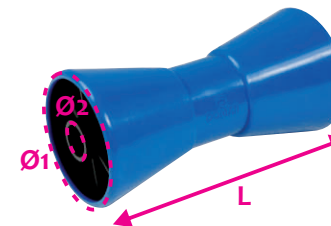

KEEL "V" ROLLER

RULLO CENTRALE
DIABLO
KIELROLLE ZENTRAL
DIABOLO LONGUER

COD	L	Ø1	Ø2
D40116	190	95	16
D40118	190	95	21
D40120	206	98	16
D40124	206	98	21

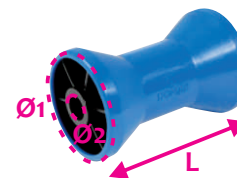

KEEL "V" ROLLER

RULLO CENTRALE
DIABLO
KIELROLLE ZENTRAL
DIABOLO LONGUER

COD	L	Ø1	Ø2
D40110	130	80	16

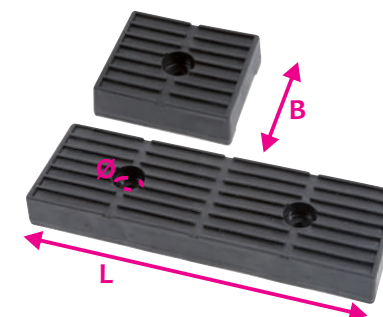

BLACK POLYETHYLENE PAD

SELLA NERA IN GOMMA
SOPORTE NEGRO DE POLIETILENE
BUGAUFLAGE SCHWARZ AUS GUMMI
PATIN NOIR EN POLYÉTHYLÈNE

COD	L	B	Ø
D41100	120	100	11
D41104	300	100	11

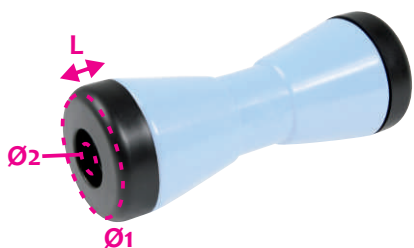

BLACK EXTENSION FOR KEEL "V" ROLLER
 TERMINALE NERO PER RULLO CENTRALE
 EXTENSIÓN NEGRA PARA RODILLO CENTRAL
 KLEMME SCHWARZ FÜR ZENTRAL KIELROLLE
 RALLONGE NOIR POUR DIABOLO

COD	L	Ø1	Ø2	Rif.
D40130	27	98	16	D40120
D40134	27	98	21	D40124

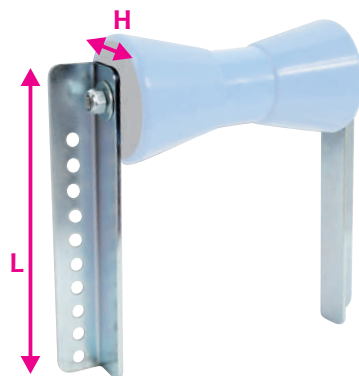

PAIR VERTICAL HOLDER FOR CENTRAL ROLLER
 COPPIA ANGOLARI PER RULLI CENTRALI
 PAREJA ANGULARES PARA RODILLOS CENTRALES
 BEFESTIGUNGSWINKEL FÜR ZENTRALE KIELROLLE
 PAIRE CORNIÈRES POUR DIABOLO

COD	L	H
D42110	250	40

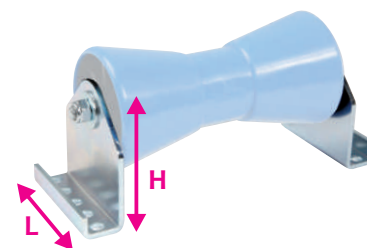

KEEL ROLLER BRACKET
 COPPIA STAFFE ZINCATE
 PER RULLI CENTRALI
 PAREJAS ABRAZADERAS ZINCADAS PARA
 RODILLOS CENTRALES
 PAAR HEMMSCHUH VERZINKT FÜR
 KIELROLLE ZENTRAL
 PAIRE ÉTRIERS ZINGUÉS POUR DIABOLO

COD	L	H
D42100	100	102

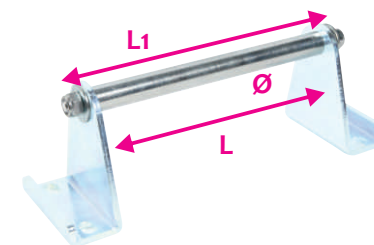

PIN FOR CENTRAL ROLLER
 PERNO PER RULLI CENTRALI
 EJE PARA RODILLO CENTRAL
 DREHSTIFT FÜR ZENTRAL KIELROLLE
 PIVOT POUR DIABOLO

COD	L	L1	Ø
D42200	136	176	15
D42204	210	250	15
D42208	258	298	15
D42304	210	250	20
D42308	258	298	20

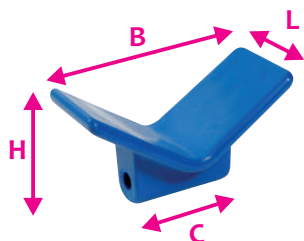

V SNUBBER IN PU NAVY COLOUR
 FERMA PRUA IN PU BLU
 TOPE EN POLIURETANO AZUL
 BUGGABEL AUS PU GRAU / BLAU
 BUTEE D'ETRAVE COLORIS BLUE

COD	L	B	H	C
D41200	70	150	80	75

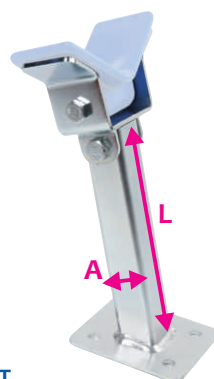

"V" SNUBBER POST
 STAFFA DI FISSAGGIO
 REGOLABILE PER FERMAPRUA
 ABRAZADERA DE FIJACION REGULABLE PARA TOPE
 HALTERUNG FÜR BUGGABEL
 SUPPORT POUR BUTEE D'ETRAVE

COD	L	A
D42600	220	40

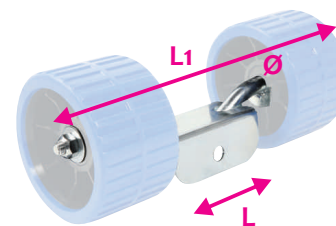

ZINC PLATED HOLDER FOR 2 WOBBLE ROLLERS
 STAFFA PER RULLO DOPPIO
 ABRAZADERA PARA RODILLO DOBLE
 STEIGBÜGEL FÜR DOPPEL KIELROLLE
 BALANCIER POUR DEUX GALETS

COD	L	L1	Ø
D42400	100	270	15

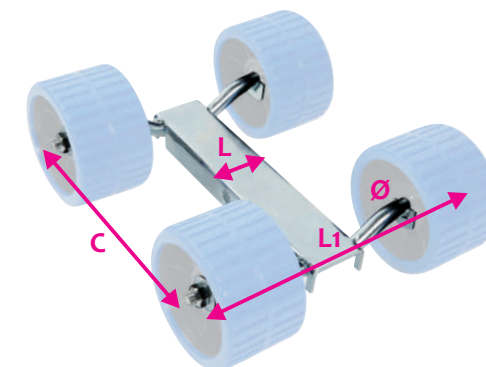

ZINC PLATED HOLDER SUITABLE FOR 4 WOBBLE ROLLERS
 STAFFA PER RULLO QUADRUPLIO
 ABRAZADERA PARA RODILLO CUADRUPLIO
 STEIGBÜGEL FÜR VIERFACH KIELROLLE
 BALANCIER POUR 4 GALETS

COD	L	L1	Ø	C
D42404	54	270	15	230