



# ERSATZTEILKATALOG

We make the brake



[www.knott-group.com](http://www.knott-group.com)

# BREMSTYP: 16-1369/1

Bremsgröße: 160x35 Spr.  
(Kegelrollenlager)

Pos. 1



Pos. 2



Pos. 3



Pos. 4



Pos. 6



Pos. 7



Pos. 8



Pos. 9



Pos. 10

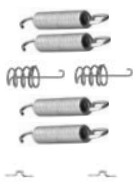

Pos. 11



Pos. 12



Pos. 13



Pos. 15



Pos. 17



Pos. 18



Pos. 14



Pos. 16



Pos. 19



Das **Original**  
und Sie fahren mit Sicherheit weiter...

Pos	Bezeichnung	Bestell- nummer
1	Bremsnabe / moyeu de frein compl. / brake hub compl. <b>100x4</b>	23851B02
2	Kappe / capouchon / cap	42191
3	Splint / boulon / spint-pin	D94.013
4	Kronenmutter / écrou crènelé / castle nut	D937.003
6	Kegelrollenlager / roulement à rouleaux coniques / taper roller bearing	45877.10
7	Kegelrollenlager / roulement à rouleaux coniques / taper roller bearing	45877.12
8	Anschlagscheibe / rondelle / washer	41582-2
9	Nachstell Set / boulon set / adjusting set	405859.001
10	Federn Set / traction set / spring set	405977.001
11	Bremsbacken Set / mâchoires de frein set / brake shoes set	405976.001
12	Spreizschloß kpl. / verrou d'ecartement / spread lever compl.	45149
13	Seilzug / câble / bowden cable ( <b>730/ 940</b> )	33921-1.06
	Seilzug / câble / bowden cable ( <b>830/1040</b> )	33921-1.07
	Seilzug / câble / bowden cable ( <b>1030/1240</b> )	33921-1.11
	Seilzug / câble / bowden cable ( <b>1230/1440</b> )	33921-1.14
	Seilzug / câble / bowden cable ( <b>1430/1640</b> )	33921-1.16
	Seilzug / câble / bowden cable ( <b>1530/1740</b> )	33921-1.17
14	Seilzug / câble / bowden cable ( <b>730/ 940</b> ) <b>Nirosta</b>	37086.06
	Seilzug / câble / bowden cable ( <b>830/1040</b> ) <b>Nirosta</b>	37086.07
	Seilzug / câble / bowden cable ( <b>1030/1240</b> ) <b>Nirosta</b>	37086.11
	Seilzug / câble / bowden cable ( <b>1230/1440</b> ) <b>Nirosta</b>	37086.14
	Seilzug / câble / bowden cable ( <b>1430/1640</b> ) <b>Nirosta</b>	37086.16
	Seilzug / câble / bowden cable ( <b>1530/1740</b> ) <b>Nirosta</b>	37086.17
15	Schale / coquille / shell	36341
16	Zugöse / anneau de couplage / drawbar eye	45207
17	Verschlußdeckel / couvercle / cover	44569.03
18	Kugelbundschrabe / vis a'embase convexe / spherical collar screw <b>M12</b>	46465.01
19	Kegelbundschrabe / vis a'embase conique / con collar screw <b>M12</b>	43696-1

# BREMSTYP: 16-1369/1

Bremsgröße: 160x35 Spr.  
(Schräggugellager)

Pos. 1



Pos. 2



Pos. 3



Pos. 4



Pos. 5



Pos. 6

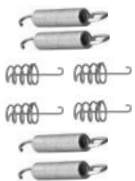

Pos. 7



Pos. 8



Pos. 9



Pos. 11



Pos. 13



Pos. 14



Pos. 10



Pos. 12



Pos. 15



Das **Original**  
und Sie fahren mit Sicherheit weiter...

Pos	Bezeichnung	Bestell- nummer
1	Bremsnabe vollst. / moyeu de frein compl. / brake hub compl. <b>100x4</b>	28742B02
	Bremsnabe vollst. / moyeu de frein compl. / brake hub compl. <b>112x5</b>	28742C02
2	Kappe / capouchon / cap	47117
3	Flanschmutter / écrou a'bridge / flanged nut	44738
4	Schrägkugellager Set <b>Ø 64mm</b> / roulment a'billes contact oblique / angular ball bearing	47305V
5	Nachstell Set / boulon set / adjusting set	405859.001
6	Federn Set / traction set / spring set	405977.001
7	Bremsbacken Set / machoires de frein set / brake shoes set	405976.001
8	Spreizschloß kpl. / verrou d'ecartement / spread lever compl.	45149
9	Seilzug / câble / bowden cable ( <b>730/ 940</b> )	33921-1.06
	Seilzug / câble / bowden cable ( <b>830/1040</b> )	33921-1.07
	Seilzug / câble / bowden cable ( <b>1030/1240</b> )	33921-1.11
	Seilzug / câble / bowden cable ( <b>1230/1440</b> )	33921-1.14
	Seilzug / câble / bowden cable ( <b>1430/1640</b> )	33921-1.16
	Seilzug / câble / bowden cable ( <b>1530/1740</b> )	33921-1.17
10	Seilzug / câble / bowden cable ( <b>730/ 940</b> ) <b>Nirosta</b>	37086.06
	Seilzug / câble / bowden cable ( <b>830/1040</b> ) <b>Nirosta</b>	37086.07
	Seilzug / câble / bowden cable ( <b>1030/1240</b> ) <b>Nirosta</b>	37086.11
	Seilzug / câble / bowden cable ( <b>1230/1440</b> ) <b>Nirosta</b>	37086.14
	Seilzug / câble / bowden cable ( <b>1430/1640</b> ) <b>Nirosta</b>	37086.16
	Seilzug / câble / bowden cable ( <b>1530/1740</b> ) <b>Nirosta</b>	37086.17
11	Schale / coquille / shell	36341
12	Zugöse / anneau de couplage / drawbar eye	45207
13	Verschlußdeckel / couvercle / cover	44569.03
14	Kugelbundschrabe / vis a'embase convexe / spherical collar screw <b>M12</b>	46465.01
15	Kegelbundschrabe / vis a'embase conique / con collar screw <b>M12</b>	43696-1

# BREMSTYP: 16-1365 (bis Bj. 1989)

Bremsgröße: 160x35 Spr.B.  
(Kegelrollenlager)

Pos. 1



Pos. 2



Pos. 3



Pos. 4



Pos. 6



Pos. 7



Pos. 8



Pos. 9



Pos. 10

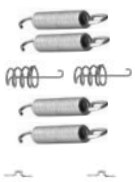

Pos. 11



Pos. 12



Pos. 13



Pos. 14



Pos. 15



Pos. 16



Das **Original**  
und Sie fahren mit Sicherheit weiter...

Pos	Bezeichnung	Bestell- nummer
1	Bremsnabe / moyeu de frein compl. / brake hub compl. <b>100x4</b>	23851B02
2	Kappe / capouchon / cap	42191
3	Splint / boulon / spint-pin	D94.013
4	Kronenmutter / écrou crènelè / castle nut	D937.003
6	Kegelrollenlager / roulement à rouleaux coniques / taper roller bearing	45877.10
7	Kegelrollenlager / roulement à rouleaux coniques / taper roller bearing	45877.12
8	Anschlagscheibe / rondelle / washer	41582-2
9	Nachstell Set / boulon set / adjusting set	406158.001
10	Federn Set / traction set / spring set	406159.001
11	Bremsbacken Set / mâchoires de frein set / brake shoes set	406160.001
12	Spreizschloß kpl. / verrou d'ecartement / spread lever compl.	43554
13	Seilzug / câble / bowden cable ( <b>900/1200</b> )	35006.14
	Seilzug / câble / bowden cable ( <b>1000/1300</b> )	35006.16
	Seilzug / câble / bowden cable ( <b>1100/1400</b> )	35006.20
	Seilzug / câble / bowden cable ( <b>1200/1500</b> )	35006.24
	Seilzug / câble / bowden cable ( <b>1400/1700</b> )	35006.28
	Seilzug / câble / bowden cable ( <b>1600/1900</b> )	35006.33
14	Verschlussdeckel / couvercle / cover	44559.01
15	Kugelbundschrabe / vis a'embase convexe / spherical collar screw <b>M12</b>	46465.01
16	Kegelbundschrabe / vis a'embase conique / con collar screw <b>M12</b>	43696-1

# BREMSTYP: 16-1365

Bremsgröße: 160x35 Spr.B.  
(Kegelrollenlager)

Pos. 1



Pos. 2



Pos. 3



Pos. 4



Pos. 6



Pos. 7



Pos. 8



Pos. 9



Pos. 10

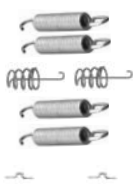

Pos. 11



Pos. 12



Pos. 13



Pos. 15



Pos. 17



Pos. 18



Pos. 14



Pos. 16



Pos. 19





Das **Original**  
und Sie fahren mit Sicherheit weiter...

Pos	Bezeichnung	Bestell- nummer
1	Bremsnabe / moyeu de frein compl. / brake hub compl. <b>100x4</b>	23851B02
2	Kappe / capouchon / cap	42191
3	Splint / boulon / spint-pin	D94.013
4	Kronenmutter / écrou crènelè / castle nut	D937.003
6	Kegelrollenlager / roulement à rouleaux coniques / taper roller bearing	45877.10
7	Kegelrollenlager / roulement à rouleaux coniques / taper roller bearing	45877.12
8	Anschlagscheibe / rondelle / washer	41582-2
9	Nachstell Set / boulon set / adjusting set	405859.001
10	Federn Set / traction set / spring set	400723.001
11	Bremsbacken Set / mâchoires de frein set / brake shoes set	402611.001
12	Spreizschloß kpl. / verrou d'ecartement / spread lever compl.	45149
13	Seilzug / câble / bowden cable ( <b>730/ 940</b> )	33921-1.06
	Seilzug / câble / bowden cable ( <b>830/1040</b> )	33921-1.07
	Seilzug / câble / bowden cable ( <b>1030/1240</b> )	33921-1.11
	Seilzug / câble / bowden cable ( <b>1230/1440</b> )	33921-1.14
	Seilzug / câble / bowden cable ( <b>1430/1640</b> )	33921-1.16
	Seilzug / câble / bowden cable ( <b>1530/1740</b> )	33921-1.17
14	Seilzug / câble / bowden cable ( <b>730/ 940</b> ) <b>Nirosta</b>	37086.06
	Seilzug / câble / bowden cable ( <b>830/1040</b> ) <b>Nirosta</b>	37086.07
	Seilzug / câble / bowden cable ( <b>1030/1240</b> ) <b>Nirosta</b>	37086.11
	Seilzug / câble / bowden cable ( <b>1230/1440</b> ) <b>Nirosta</b>	37086.14
	Seilzug / câble / bowden cable ( <b>1430/1640</b> ) <b>Nirosta</b>	37086.16
	Seilzug / câble / bowden cable ( <b>1530/1740</b> ) <b>Nirosta</b>	37086.17
15	Schale / coquille / shell	36341
16	Zugöse / anneau de couplage / drawbar eye	45207
17	Verschlußdeckel / couvercle / cover	44569.03
18	Kugelbundschrabe / vis a'embase convexe / spherical collar screw <b>M12</b>	46465.01
19	Kegelbundschrabe / vis a'embase conique / con collar screw <b>M12</b>	43696-1

# BREMSTYP: 16-1365 (Avonride)

Bremsgröße: 160x35 Spr.B.

(Kegelrollenlager)

Pos. 1



Pos. 2



Pos. 3



Pos. 4



Pos. 5



Pos. 6



Pos. 7



Pos. 8



Pos. 9



Pos. 10

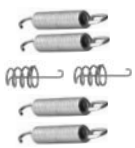

Pos. 11



Pos. 12



Pos. 13



Pos. 15



Pos. 17



Pos. 18



Pos. 14



Pos. 16



Das **Original**  
und Sie fahren mit Sicherheit weiter...

Pos	Bezeichnung	Bestell- nummer
1	Bremsnabe / moyeu de frein compl. / brake hub compl. <b>100x4</b>	406154B001
2	Kappe / capouchon / cap	406140.001
3	Splint / boulon / spint-pin	D94.014
4	Kronenmutter / écrou crènelè / castle nut	406142.001
5	Scheibe / rondelle / washer	406152.001
6	Kegelrollenlager / roulement à rouleaux coniques / taper roller bearing	406144.001
7	Kegelrollenlager / roulement à rouleaux coniques / taper roller bearing	406145.001
8	Anschlagscheibe / rondelle / washer	406146.001
9	Nachstell Set / boulon set / adjusting set	405859.001
10	Federn Set / traction set / spring set	400723.001
11	Bremsbacken Set / mâchoires de frein set / brake shoes set	402611.001
12	Spreizschloß kpl. / verrou d'ecartement / spread lever compl.	45149
13	Seilzug / câble / bowden cable ( <b>730/ 940</b> )	33921-1.06
	Seilzug / câble / bowden cable ( <b>830/1040</b> )	33921-1.07
	Seilzug / câble / bowden cable ( <b>1030/1240</b> )	33921-1.11
	Seilzug / câble / bowden cable ( <b>1230/1440</b> )	33921-1.14
	Seilzug / câble / bowden cable ( <b>1430/1640</b> )	33921-1.16
	Seilzug / câble / bowden cable ( <b>1530/1740</b> )	33921-1.17
14	Seilzug / câble / bowden cable ( <b>730/ 940</b> ) <b>Nirosta</b>	37086.06
	Seilzug / câble / bowden cable ( <b>830/1040</b> ) <b>Nirosta</b>	37086.07
	Seilzug / câble / bowden cable ( <b>1030/1240</b> ) <b>Nirosta</b>	37086.11
	Seilzug / câble / bowden cable ( <b>1230/1440</b> ) <b>Nirosta</b>	37086.14
	Seilzug / câble / bowden cable ( <b>1430/1640</b> ) <b>Nirosta</b>	37086.16
	Seilzug / câble / bowden cable ( <b>1530/1740</b> ) <b>Nirosta</b>	37086.17
15	Schale / coquille / shell	36341
16	Zugöse / anneau de couplage / drawbar eye	45207
17	Verschlußdeckel / couvercle / cover	44569.03
18	Kegelbundmutter / écrou a bridge / flanged nut <b>M12</b>	D74361.003

# BREMSTYP: 16-1365

Bremsgröße: 160x35 Spr.B.  
(Schrägkugellager)

Pos. 1



Pos. 2



Pos. 3



Pos. 4



Pos. 5



Pos. 6

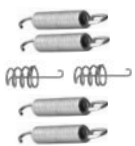

Pos. 7



Pos. 8



Pos. 9



Pos. 11



Pos. 13



Pos. 14



Pos. 10



Pos. 12



Pos. 15



Das **Original**  
und Sie fahren mit Sicherheit weiter...

Pos	Bezeichnung	Bestell- nummer
1	Bremsnabe vollst. / moyeu de frein compl. / brake hub compl. <b>100x4</b>	28742B02
	Bremsnabe vollst. / moyeu de frein compl. / brake hub compl. <b>112x5</b>	28742C02
2	Kappe / capouchon / cap	47117
3	Flanschmutter / écrou a'bridge / flanged nut	44738
4	Schrägkugellager Set <b>Ø 64mm</b> / roulment a'billes contact oblique / angular ball bearing	47305V
5	Nachstell Set / boulon set / adjusting set	405859.001
6	Federn Set / traction set / spring set	400723.001
7	Bremsbacken Set / machoires de frein set / brake shoes set	402611.001
8	Spreizschloß kpl. / verrou d'ecartement / spread lever compl.	45149
9	Seilzug / câble / bowden cable ( <b>730/ 940</b> )	33921-1.06
	Seilzug / câble / bowden cable ( <b>830/1040</b> )	33921-1.07
	Seilzug / câble / bowden cable ( <b>1030/1240</b> )	33921-1.11
	Seilzug / câble / bowden cable ( <b>1230/1440</b> )	33921-1.14
	Seilzug / câble / bowden cable ( <b>1430/1640</b> )	33921-1.16
10	Seilzug / câble / bowden cable ( <b>730/ 940</b> ) <b>Nirosta</b>	37086.06
	Seilzug / câble / bowden cable ( <b>830/1040</b> ) <b>Nirosta</b>	37086.07
	Seilzug / câble / bowden cable ( <b>1030/1240</b> ) <b>Nirosta</b>	37086.11
	Seilzug / câble / bowden cable ( <b>1230/1440</b> ) <b>Nirosta</b>	37086.14
	Seilzug / câble / bowden cable ( <b>1430/1640</b> ) <b>Nirosta</b>	37086.16
	Seilzug / câble / bowden cable ( <b>1530/1740</b> ) <b>Nirosta</b>	37086.17
11	Schale / coquille / shell	36341
12	Zugöse / anneau de couplage / drawbar eye	45207
13	Verschlußdeckel / couvercle / cover	44569.03
14	Kugelbundschrabe / vis a'embase convexe / spherical collar screw <b>M12</b>	46465.01
15	Kegelbundschrabe / vis a'embase conique / con collar screw <b>M12</b>	43696-1

# BREMSTYP: 20-965/1

Bremsgröße: 200x30 Spr.  
(Kegelrollenlager)

Pos. 1



Pos. 2



Pos. 3



Pos. 4



Pos. 5



Pos. 6



Pos. 7



Pos. 8



Pos. 9



Pos. 10

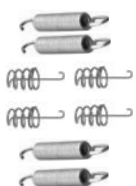

Pos. 11

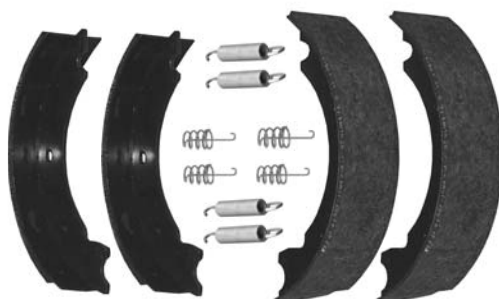

Pos. 12



Pos. 13



Pos. 14



Pos. 15



Pos. 16



Das **Original**  
und Sie fahren mit Sicherheit weiter...

Pos	Bezeichnung	Bestell- nummer
1	Bremsnabe 13" / moyeu de frein compl. / brake hub compl. <b>100x4</b>	21225-1B02
	Bremsnabe 13" / moyeu de frein compl. / brake hub compl. <b>112x5</b>	21225-1C02
2	Kappe / capouchon / cap Ø 52,1mm	42843-1
3	Splint / boulon / spint-pin	D94.015
4	Kronenmutter / écrou crènelé / castle nut	D937.005
5	Scheibe / rondelle / washer	43501
6	Kegelrollenlager / roulement à rouleaux coniques / taper roller bearing	45877.11
7	Kegelrollenlager / roulement à rouleaux coniques / taper roller bearing	45877.12
8	Anschlagscheibe / rondelle / washer	41582-2
9	Nachstell Set / boulon set / adjusting set	405980.001
10	Federn Set / traction set / spring set	405979.001
11	Bremsbacken Set / mâchoires de frein set / brake shoes set	405978.001
12	Spreizschloß kpl. / verrou d'ecartement / spread lever compl.	45309
13	Seilzug / câble / bowden cable ( 900/1200)	35006.14
	Seilzug / câble / bowden cable (1000/1300)	35006.16
	Seilzug / câble / bowden cable (1100/1400)	35006.20
	Seilzug / câble / bowden cable (1200/1500)	35006.24
	Seilzug / câble / bowden cable (1400/1700)	35006.28
	Seilzug / câble / bowden cable (1600/1900)	35006.33
14	Verschlußdeckel / couvercle / cover	44569.03
15	Kugelbundschrabe / vis a'embase convexe / spherical collar screw <b>M12</b>	46465.01
16	Kegelbundschrabe / vis a'embase conique / con collar screw <b>M12</b>	43696-1

# BREMSTYP: 20-963/1

Bremsgröße: 200x30 Spr. B.  
(Kegelrollenlager)

Pos. 1



Pos. 2



Pos. 3



Pos. 4



Pos. 5



Pos. 6



Pos. 7



Pos. 8



Pos. 9



Pos. 10

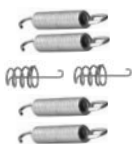

Pos. 11

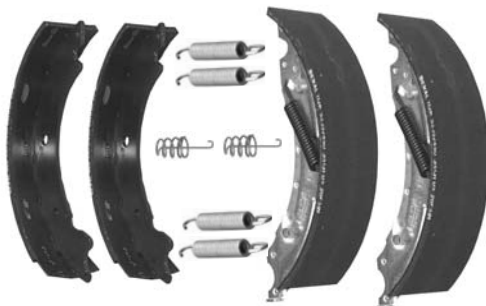

Pos. 12



Pos. 13



Pos. 14



Pos. 15



Pos. 16





Das **Original**  
und Sie fahren mit Sicherheit weiter...

Pos	Bezeichnung	Bestell- nummer
1	Bremsnabe 13" / moyeu de frein compl. / brake hub compl. <b>100x4</b>	21225-1B02
	Bremsnabe 13" / moyeu de frein compl. / brake hub compl. <b>112x5</b>	21225-1C02
2	Kappe / capouchon / cap Ø 52,1mm	42843-1
3	Splint / boulon / spint-pin	D94.015
4	Kronenmutter / écrou crènelè / castle nut	D937.005
5	Scheibe / rondelle / washer	43501
6	Kegelrollenlager / roulement à rouleaux coniques / taper roller bearing	45877.11
7	Kegelrollenlager / roulement à rouleaux coniques / taper roller bearing	45877.12
8	Anschlagscheibe / rondelle / washer	41582-2
9	Nachstell Set / boulon set / adjusting set	405980.001
10	Federn Set / traction set / spring set	405981.001
11	Bremsbacken Set / mâchoires de frein set / brake shoes set	403132.001
12	Spreizschloß kpl. / verrou d'ecartement / spread lever compl.	45309
13	Seilzug / câble / bowden cable ( 900/1200)	35006.14
	Seilzug / câble / bowden cable (1000/1300)	35006.16
	Seilzug / câble / bowden cable (1100/1400)	35006.20
	Seilzug / câble / bowden cable (1200/1500)	35006.24
	Seilzug / câble / bowden cable (1400/1700)	35006.28
	Seilzug / câble / bowden cable (1600/1900)	35006.33
14	Verschlußdeckel / couvercle / cover	44569.03
15	Kugelbundschrabe / vis a'embase convexe / spherical collar screw <b>M12</b>	46465.01
16	Kegelbundschrabe / vis a'embase conique / con collar screw <b>M12</b>	43696-1

# BREMSTYP: 20-966/1

Bremsgröße: 200x50 Spr.  
(Kegelrollenlager)

Pos. 1



Pos. 2



Pos. 3



Pos. 4



Pos. 5



Pos. 6



Pos. 7



Pos. 8



Pos. 9



Pos. 10

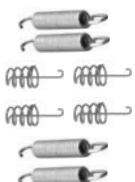

Pos. 11



Pos. 12



Pos. 13



Pos. 14



Pos. 15



Pos. 16



Das **Original**  
und Sie fahren mit Sicherheit weiter...

Pos	Bezeichnung	Bestell- nummer
1	Bremsnabe 13" / moyeu de frein compl. / brake hub compl. <b>100x4</b>	21225-1B02
	Bremsnabe 13" / moyeu de frein compl. / brake hub compl. <b>112x5</b>	21225-1C02
2	Kappe / capouchon / cap Ø 52,1mm	42843-1
3	Splint / boulon / spint-pin	D94.015
4	Kronenmutter / écrou crènelé / castle nut	D937.005
5	Scheibe / rondelle / washer	43501
6	Kegelrollenlager / roulement à rouleaux coniques / taper roller bearing	45877.11
7	Kegelrollenlager / roulement à rouleaux coniques / taper roller bearing	45877.12
8	Anschlagscheibe / rondelle / washer	41582-2
9	Nachstell Set / boulon set / adjusting set	405980.001
10	Federn Set / traction set / spring set	405999.001
11	Bremsbacken Set / mâchoires de frein set / brake shoes set	406161.001
12	Spreizschloß kpl. / verrou d'ecartement / spread lever compl.	45309
13	Seilzug / câble / bowden cable ( 900/1200)	35006.14
	Seilzug / câble / bowden cable (1000/1300)	35006.16
	Seilzug / câble / bowden cable (1100/1400)	35006.20
	Seilzug / câble / bowden cable (1200/1500)	35006.24
	Seilzug / câble / bowden cable (1400/1700)	35006.28
	Seilzug / câble / bowden cable (1600/1900)	35006.33
14	Verschlußdeckel / couvercle / cover	44569.03
15	Kugelbundschrabe / vis a'embase convexe / spherical collar screw <b>M12</b>	46465.01
16	Kegelbundschrabe / vis a'embase conique / con collar screw <b>M12</b>	43696-1

# BREMSTYP: 20-964/1

Bremsgröße: 200x50 Spr. B.  
(Kegelrollenlager)

Pos. 1



Pos. 2



Pos. 3



Pos. 4



Pos. 5



Pos. 6



Pos. 7



Pos. 8



Pos. 9



Pos. 10

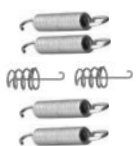

Pos. 11

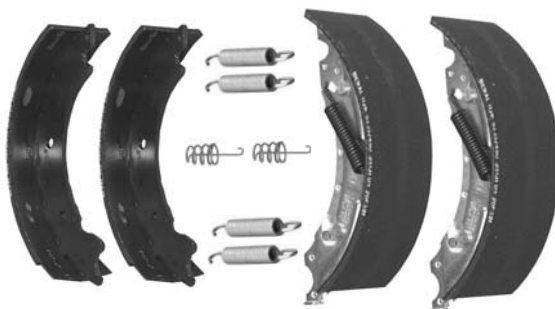

Pos. 12



Pos. 13



Pos. 14



Pos. 15



Pos. 16



Das **Original**  
und Sie fahren mit Sicherheit weiter...

Pos	Bezeichnung	Bestell- nummer
1	Bremsnabe 13" / moyeu de frein compl. / brake hub compl. <b>100x4</b>	21225-1B02
	Bremsnabe 13" / moyeu de frein compl. / brake hub compl. <b>112x5</b>	21225-1C02
2	Kappe / capouchon / cap Ø 52,1mm	42843-1
3	Splint / boulon / spint-pin	D94.015
4	Kronenmutter / écrou crènelè / castle nut	D937.005
5	Scheibe / rondelle / washer	43501
6	Kegelrollenlager / roulement à rouleaux coniques / taper roller bearing	45877.11
7	Kegelrollenlager / roulement à rouleaux coniques / taper roller bearing	45877.12
8	Anschlagscheibe / rondelle / washer	41582-2
9	Nachstell Set / boulon set / adjusting set	405980.001
10	Federn Set / traction set / spring set	400724.001
11	Bremsbacken Set / mâchoires de frein set / brake shoes set	47276
12	Spreizschloß kpl. / verrou d'ecartement / spread lever compl.	45309
13	Seilzug / câble / bowden cable ( 900/1200)	35006.14
	Seilzug / câble / bowden cable (1000/1300)	35006.16
	Seilzug / câble / bowden cable (1100/1400)	35006.20
	Seilzug / câble / bowden cable (1200/1500)	35006.24
	Seilzug / câble / bowden cable (1400/1700)	35006.28
	Seilzug / câble / bowden cable (1600/1900)	35006.33
14	Verschlußdeckel / couvercle / cover	44569.03
15	Kugelbundschrabe / vis a'embase convexe / spherical collar screw <b>M12</b>	46465.01
16	Kegelbundschrabe / vis a'embase conique / con collar screw <b>M12</b>	43696-1

# BREMSTYP: 20-2426/1

Bremsgröße: 200x50 Spr.  
(Schrägkugellager)

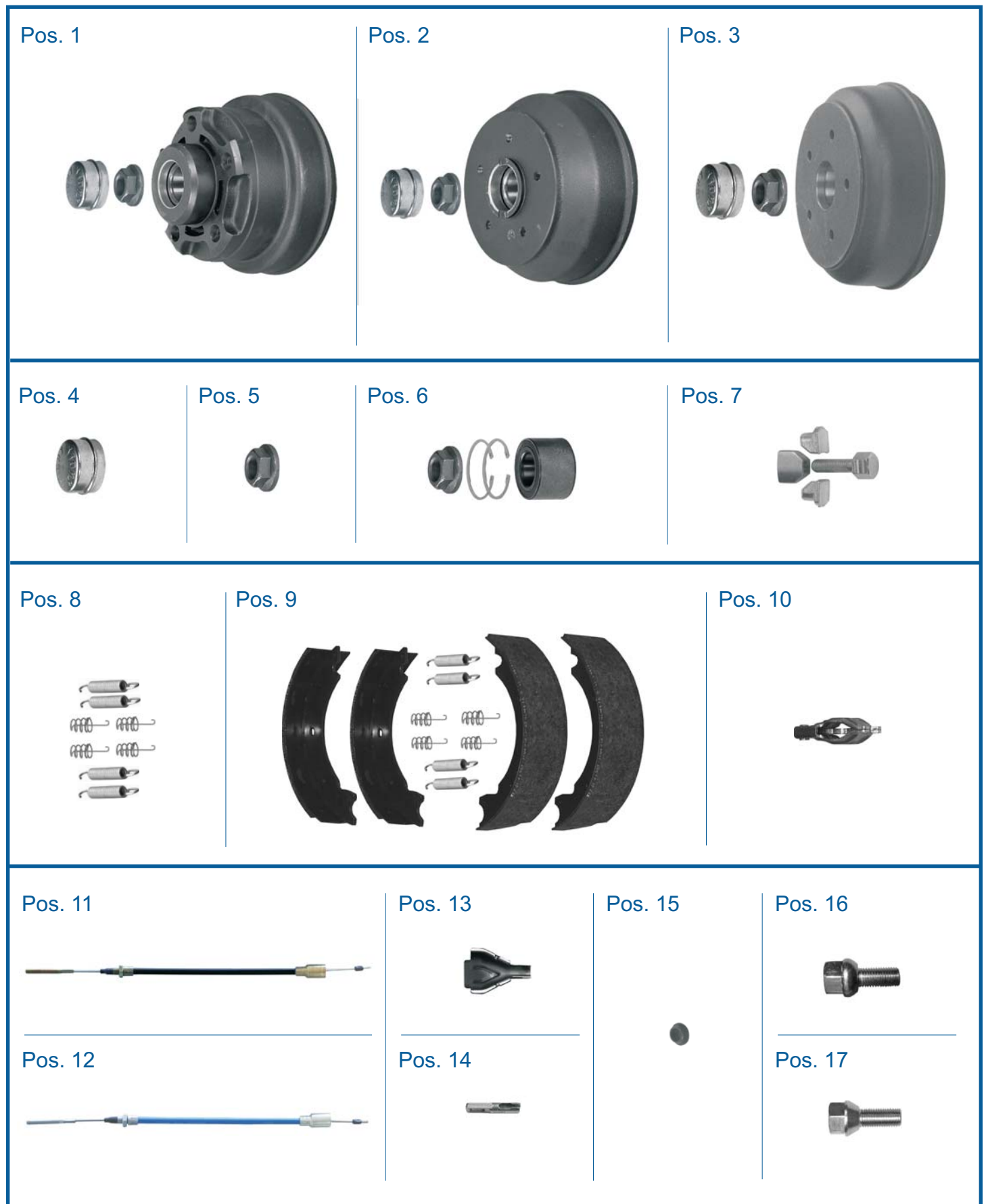

Das **Original**  
und Sie fahren mit Sicherheit weiter...

Pos	Bezeichnung	Bestell- nummer	
1	Bremsnabe vollst. 8" / moyeu de frein compl. / brake hub compl. <b>140x5</b>	401935N001	
2	Bremsnabe vollst. 10" / moyeu de frein compl. / brake hub compl. <b>112x5</b>	28744C02	
	Bremsnabe vollst. 10" / moyeu de frein compl. / brake hub compl. <b>112x5</b> wasserdicht / étanché / waterproof	28739C02	
	Bremsnabe vollst. 10" / moyeu de frein compl. / brake hub compl. <b>140x5</b>	28744N02	
	Bremsnabe vollst. 10" / moyeu de frein compl. / brake hub compl. <b>140x5</b> wasserdicht / étanché / waterproof	28739N02	
	3	Bremsnabe vollst. 13" / moyeu de frein compl. / brake hub compl. <b>100x4</b>	28745B02
		Bremsnabe vollst. 13" / moyeu de frein compl. / brake hub compl. <b>100x4</b> wasserdicht / étanché / waterproof	28738B02
Bremsnabe vollst. 13" / moyeu de frein compl. / brake hub compl. <b>112x5</b>		28745C02	
Bremsnabe vollst. 13" / moyeu de frein compl. / brake hub compl. <b>112x5</b> wasserdicht / étanché / waterproof		28738C02	
4		Kappe Ø <b>52,1mm</b> / capouchon / cap	47117
	Kappe Ø <b>64,0mm</b> / capouchon / cap	47151	
5	Flanschmutter / écrou a'bridge / flanged nut	44738	
6	Schräggugellager Set Ø <b>64mm</b> / roulment a'billes contact oblique / angular ball bearing	47305V	
	Schräggugellager Set Ø <b>72mm</b> / roulment a'billes contact oblique / angular ball bearing	47306V	
7	Nachstell Set / boulon set / adjusting set	405859.001	
8	Federn Set / traction set / spring set	405999.001	
9	Bremsbacken Set / machoires de frein set / brake shoes set	406161.001	
10	Spreizschloß kpl. / verrou d'ecartement / spread lever compl.	45309	
11	Seilzug / câble / bowden cable ( <b>730/ 940</b> )	33921-1.06	
	Seilzug / câble / bowden cable ( <b>830/1040</b> )	33921-1.07	
	Seilzug / câble / bowden cable ( <b>1030/1240</b> )	33921-1.11	
	Seilzug / câble / bowden cable ( <b>1230/1440</b> )	33921-1.14	
	Seilzug / câble / bowden cable ( <b>1430/1640</b> )	33921-1.16	
	Seilzug / câble / bowden cable ( <b>1530/1740</b> )	33921-1.17	
12	Seilzug / câble / bowden cable ( <b>730/ 940</b> ) <b>Nirosta</b>	37086.06	
	Seilzug / câble / bowden cable ( <b>830/1040</b> ) <b>Nirosta</b>	37086.07	
	Seilzug / câble / bowden cable ( <b>1030/1240</b> ) <b>Nirosta</b>	37086.11	
	Seilzug / câble / bowden cable ( <b>1230/1440</b> ) <b>Nirosta</b>	37086.14	
	Seilzug / câble / bowden cable ( <b>1430/1640</b> ) <b>Nirosta</b>	37086.16	
	Seilzug / câble / bowden cable ( <b>1530/1740</b> ) <b>Nirosta</b>	37086.17	
13	Schale / coquille / shell	36341	
14	Zugöse / anneau de couplage / drawbar eye	45207	
15	Verschlußdeckel / couvercle / cover	44569.03	
16	Kugelbundschrabe / vis a'embase convexe / spherical collar screw <b>M12</b>	46465.01	
	Kugelbundschrabe / vis a'embase convexe / spherical collar screw <b>M14</b>	43777.01	
17	Kegelbundschrabe / vis a'embase conique / con collar screw <b>M12</b>	43696-1	

# BREMSTYP: 20-2425/1

Bremsgröße: 200x50 Spr.B.  
(Schrägkugellager)

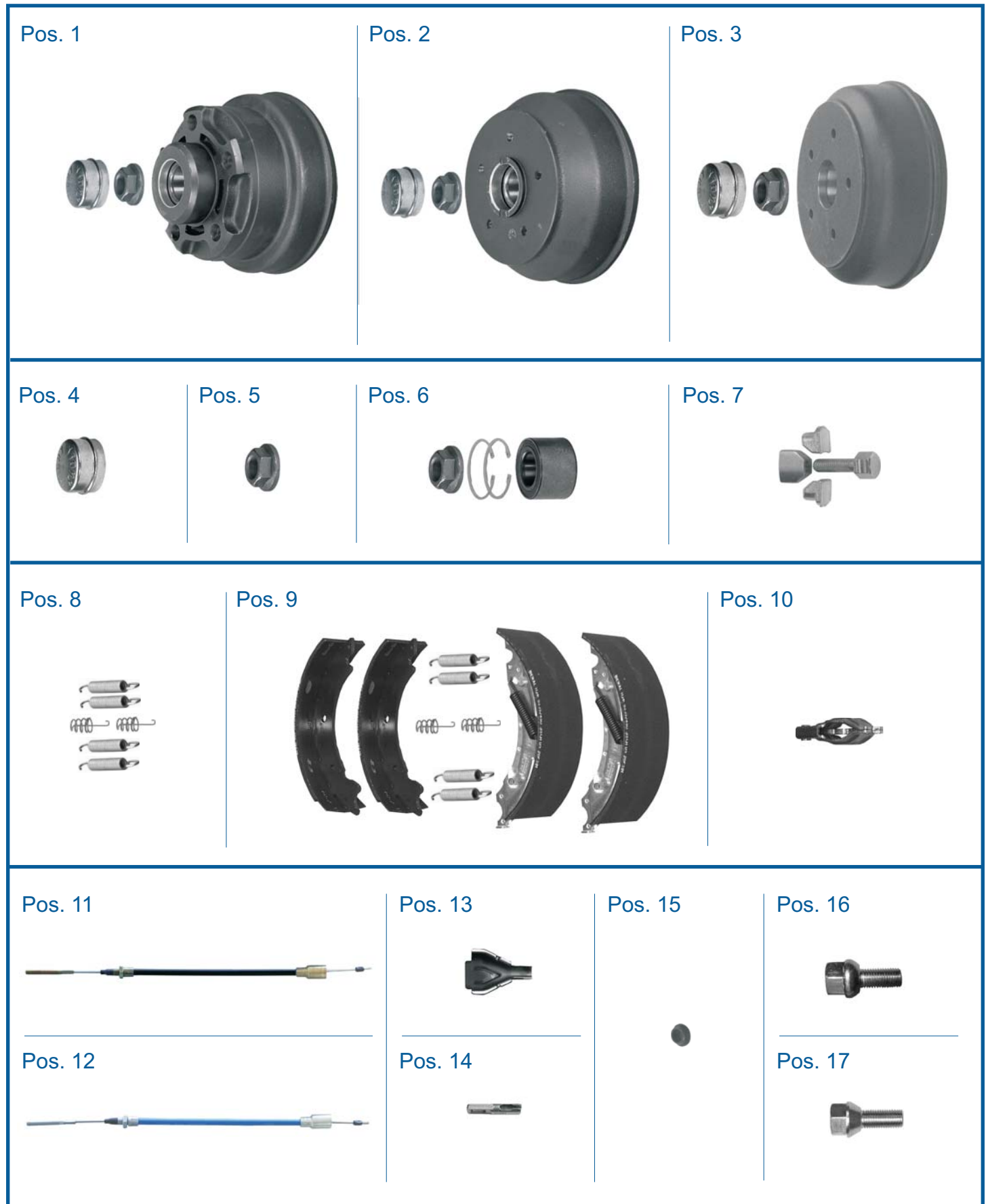



Das **Original**  
und Sie fahren mit Sicherheit weiter...

Pos	Bezeichnung	Bestell- nummer
1	Bremsnabe vollst. 8" / moyeu de frein compl. / brake hub compl. <b>140x5</b>	401935N001
2	Bremsnabe vollst. 10" / moyeu de frein compl. / brake hub compl. <b>112x5</b>	28744C02
	Bremsnabe vollst. 10" / moyeu de frein compl. / brake hub compl. <b>112x5</b>	28739C02
	Wasserdicht / / waterproof	
	Bremsnabe vollst. 10" / moyeu de frein compl. / brake hub compl. <b>140x5</b>	28744N02
	Bremsnabe vollst. 10" / moyeu de frein compl. / brake hub compl. <b>140x5</b>	28739N02
	Wasserdicht / / waterproof	
3	Bremsnabe vollst. 13" / moyeu de frein compl. / brake hub compl. <b>100x4</b>	28745B02
	Bremsnabe vollst. 13" / moyeu de frein compl. / brake hub compl. <b>100x4</b>	28738B02
	Wasserdicht / / waterproof	
	Bremsnabe vollst. 13" / moyeu de frein compl. / brake hub compl. <b>112x5</b>	28745C02
	Bremsnabe vollst. 13" / moyeu de frein compl. / brake hub compl. <b>112x5</b>	28738C02
	Wasserdicht / / waterproof	
4	Kappe Ø 52,1mm / capouchon / cap	47117
	Kappe Ø 64,0mm / capouchon / cap	47151
5	Flanschmutter / écrou a'bridge / flanged nut	44738
6	Schrägkugellager Set Ø <b>64mm</b> / roulment a'billes contact oblique / angular ball bearing	47305V
	Schrägkugellager Set Ø <b>72mm</b> / roulment a'billes contact oblique / angular ball bearing	47306V
7	Nachstell Set / boulon set / adjusting set	405859.001
8	Federn Set / traction set / spring set	400724.001
9	Bremsbacken Set / machoires de frein set / brake shoes set	47276
10	Spreizschloß kpl. / verrou d'ecartement / spread lever compl.	45309
11	Seilzug / câble / bowden cable ( <b>730/ 940</b> )	33921-1.06
	Seilzug / câble / bowden cable ( <b>830/1040</b> )	33921-1.07
	Seilzug / câble / bowden cable ( <b>1030/1240</b> )	33921-1.11
	Seilzug / câble / bowden cable ( <b>1230/1440</b> )	33921-1.14
	Seilzug / câble / bowden cable ( <b>1430/1640</b> )	33921-1.16
	Seilzug / câble / bowden cable ( <b>1530/1740</b> )	33921-1.17
12	Seilzug / câble / bowden cable ( <b>730/ 940</b> ) <b>Nirosta</b>	37086.06
	Seilzug / câble / bowden cable ( <b>830/1040</b> ) <b>Nirosta</b>	37086.07
	Seilzug / câble / bowden cable ( <b>1030/1240</b> ) <b>Nirosta</b>	37086.11
	Seilzug / câble / bowden cable ( <b>1230/1440</b> ) <b>Nirosta</b>	37086.14
	Seilzug / câble / bowden cable ( <b>1430/1640</b> ) <b>Nirosta</b>	37086.16
	Seilzug / câble / bowden cable ( <b>1530/1740</b> ) <b>Nirosta</b>	37086.17
13	Schale / coquille / shell	36341
14	Zugöse / anneau de couplage / drawbar eye	45207
15	Verschlußdeckel / couvercle / cover	44569.03
16	Kugelbundschrabe / vis a'embase convexe / spherical collar screw <b>M12</b>	46465.01
	Kugelbundschrabe / vis a'embase convexe / spherical collar screw <b>M14</b>	43777.01
17	Kegelbundschrabe / vis a'embase conique / con collar screw <b>M12</b>	43696-1

# BREMSTYP: 20-2425/1 Avonride

Bremsgröße: 200x50 Spr.B.  
(Kegelrollenlager)

Pos. 1



Pos. 2



Pos. 3



Pos. 4



Pos. 5



Pos. 6



Pos. 7



Pos. 8



Pos. 9



Pos. 10

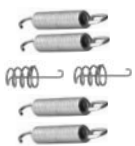

Pos. 11

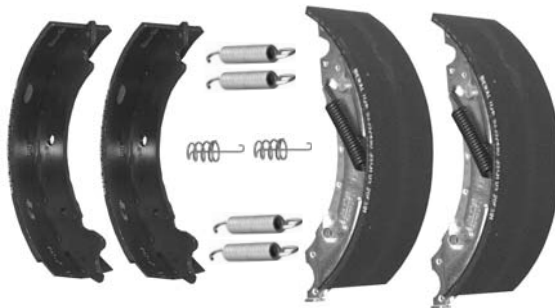

Pos. 12



Pos. 13



Pos. 15



Pos. 17



Pos. 18



Pos. 14



Pos. 16



Das **Original**  
und Sie fahren mit Sicherheit weiter...

Pos	Bezeichnung	Bestell- nummer
1	Bremsnabe / moyeu de frein compl. / brake hub compl. <b>100x4</b>	406155B001
	Bremsnabe / moyeu de frein compl. / brake hub compl. <b>112x5</b>	406155C001
	Bremsnabe / moyeu de frein compl. / brake hub compl. <b>139,7x4</b>	406155K001
2	Kappe / capouchon / cap	406140.001
3	Splint / boulon / spint-pin	D94.014
4	Kronenmutter / écrou crènelè / castle nut	406142.001
5	Scheibe / rondelle / washer	406152.001
6	Kegelrollenlager / roulement à rouleaux coniques / taper roller bearing	406144.001
7	Kegelrollenlager / roulement à rouleaux coniques / taper roller bearing	406147.001
8	Anschlagscheibe / rondelle / washer	406148.001
9	Nachstell Set / boulon set / adjusting set	405859.001
10	Federn Set / traction set / spring set	400724.001
11	Bremsbacken Set / mâchoires de frein set / brake shoes set	47276
12	Spreizschloß kpl. / verrou d'ecartement / spread lever compl.	45309
13	Seilzug / câble / bowden cable ( <b>730/ 940</b> )	33921-1.06
	Seilzug / câble / bowden cable ( <b>830/1040</b> )	33921-1.07
	Seilzug / câble / bowden cable ( <b>1030/1240</b> )	33921-1.11
	Seilzug / câble / bowden cable ( <b>1230/1440</b> )	33921-1.14
	Seilzug / câble / bowden cable ( <b>1430/1640</b> )	33921-1.16
	Seilzug / câble / bowden cable ( <b>1530/1740</b> )	33921-1.17
14	Seilzug / câble / bowden cable ( <b>730/ 940</b> ) <b>Nirosta</b>	37086.06
	Seilzug / câble / bowden cable ( <b>830/1040</b> ) <b>Nirosta</b>	37086.07
	Seilzug / câble / bowden cable ( <b>1030/1240</b> ) <b>Nirosta</b>	37086.11
	Seilzug / câble / bowden cable ( <b>1230/1440</b> ) <b>Nirosta</b>	37086.14
	Seilzug / câble / bowden cable ( <b>1430/1640</b> ) <b>Nirosta</b>	37086.16
	Seilzug / câble / bowden cable ( <b>1530/1740</b> ) <b>Nirosta</b>	37086.17
15	Schale / coquille / shell	36341
16	Zugöse / anneau de couplage / drawbar eye	45207
17	Verschlußdeckel / couvercle / cover	44569.03
18	Kegelbundmutter / écrou a bridge / flanged nut <b>M12</b>	D74361.003

# BREMSTYP: 20-2711

Bremsgröße: 200x50 Hydraulik Simplex  
(Schrägkugellager)

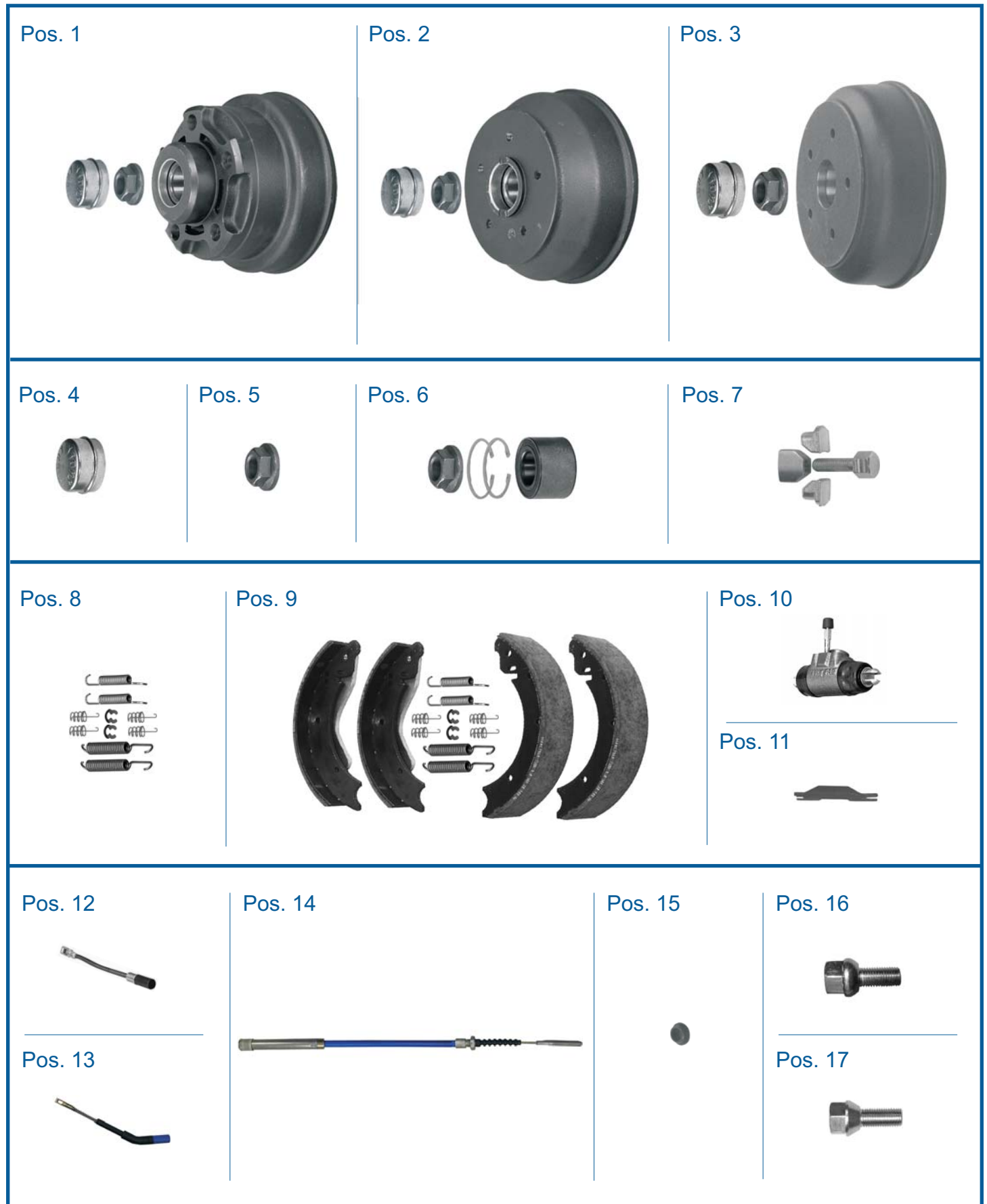

Das **Original**  
und Sie fahren mit Sicherheit weiter...

Pos	Bezeichnung	Bestell- nummer
1	Bremsnabe vollst. 8" / moyeu de frein compl. / brake hub compl. <b>140x5</b>	401935N001
2	Bremsnabe vollst. 10" / moyeu de frein compl. / brake hub compl. <b>112x5</b>	28744C02
	Bremsnabe vollst. 10" / moyeu de frein compl. / brake hub compl. <b>140x5</b>	28744N02
3	Bremsnabe vollst. 13" / moyeu de frein compl. / brake hub compl. <b>100x4</b>	28745B02
	Bremsnabe vollst. 13" / moyeu de frein compl. / brake hub compl. <b>112x5</b>	28745C02
4	Kappe <b>Ø 52,1mm</b> / capouchon / cap	47117
	Kappe <b>Ø 64,0mm</b> / capouchon / cap	47151
5	Flanschmutter / écrou a'bridge / flanged nut	44738
6	Schräggugellager Set <b>Ø 64mm</b> / roulment a'billes contact oblique / angular ball bearing	47305V
	Schräggugellager Set <b>Ø 72mm</b> / roulment a'billes contact oblique / angular ball bearing	47306V
7	Nachstell Set / boulon set / adjusting set	405859.001
8	Federn Set / traction set / spring set	406000.001
9	Bremsbacken Set / machoires de frein set / brake shoes set	406162.001
10	Radzylinder / cylindre de frein de roue / wheel brake cylindre <b>Ø 25,40 mm</b>	33455
	Radzylinder / cylindre de frein de roue / wheel brake cylindre <b>Ø 22,20 mm</b>	36865
	Radzylinder / cylindre de frein de roue / wheel brake cylindre <b>Ø 19,05 mm</b>	36407
	Radzylinder / cylindre de frein de roue / wheel brake cylindre <b>Ø 15,87 mm</b>	100570
11	Stößel / tige-pussoir / tappet links	44845.01
	Stößel / tige-pussoir / tappet rechts	44845.02
12	Seilzug-Adapter / câble adapter / bowden cable adapter <b>Nirosta gerade</b>	980074.01
13	Seilzug-Adapter / câble adapter / bowden cable adapter <b>Nirosta gekröpft 30°</b>	980077
14	Seilzug / câble / bowden cable <b>(1150/1310) Nirosta</b>	98055.02
	Seilzug / câble / bowden cable <b>(1350/1510) Nirosta</b>	98055.15
	Seilzug / câble / bowden cable <b>(1650/1810) Nirosta</b>	98055.01
	Seilzug / câble / bowden cable <b>(1850/2010) Nirosta</b>	98055.12
	Seilzug / câble / bowden cable <b>(2050/2210) Nirosta</b>	98055.16
	Seilzug / câble / bowden cable <b>(2250/2410) Nirosta</b>	98055.03
15	Verschlußdeckel / couvercle / cover	44569.03
16	Kugelbundschrabe / vis a'embase convexe / spherical collar screw <b>M12</b>	46465.01
	Kugelbundschrabe / vis a'embase convexe / spherical collar screw <b>M14</b>	43777.01
17	Kegelbundschrabe / vis a'embase conique / con collar screw <b>M12</b>	43696-1

# BREMSTYP: 20-2710

Bremsgröße: 200x50 Hydraulik Backmat  
(Schräggugellager)

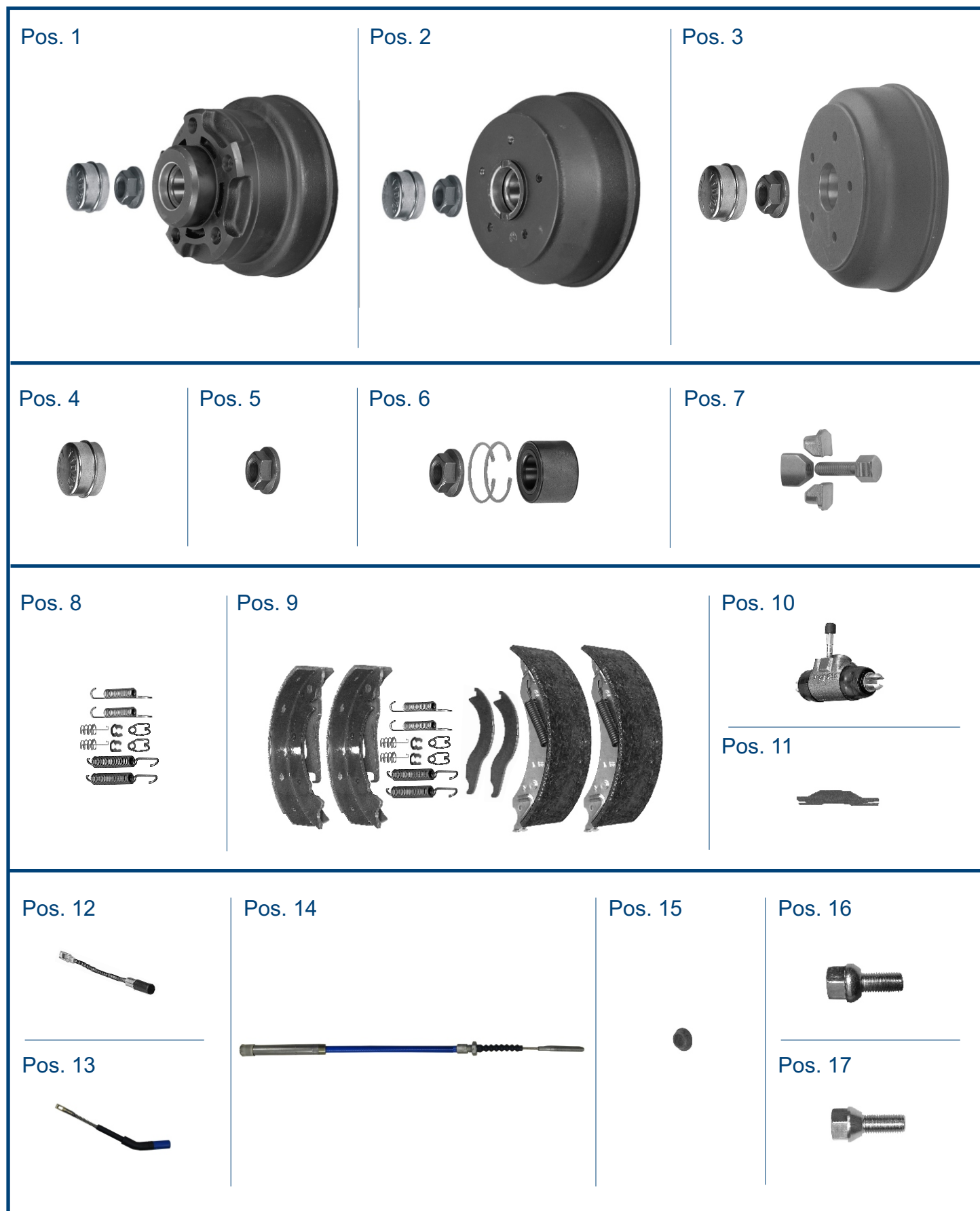

Das **Original**  
und Sie fahren mit Sicherheit weiter...

Pos	Bezeichnung	Bestell- nummer
1	Bremsnabe vollst. 8" / moyeu de frein compl. / brake hub compl. <b>140x5</b>	401935N001
2	Bremsnabe vollst. 10" / moyeu de frein compl. / brake hub compl. <b>112x5</b>	28744C02
	Bremsnabe vollst. 10" / moyeu de frein compl. / brake hub compl. <b>140x5</b>	28744N02
3	Bremsnabe vollst. 13" / moyeu de frein compl. / brake hub compl. <b>100x4</b>	28745B02
	Bremsnabe vollst. 13" / moyeu de frein compl. / brake hub compl. <b>112x5</b>	28745C02
4	Kappe <b>Ø 52,1mm</b> / capouchon / cap	47117
	Kappe <b>Ø 64,0mm</b> / capouchon / cap	47151
5	Flanschmutter / écrou a'bridge / flanged nut	44738
6	Schräggugellager Set <b>Ø 64mm</b> / roulment a'billes contact oblique / angular ball bearing	47305V
	Schräggugellager Set <b>Ø 72mm</b> / roulment a'billes contact oblique / angular ball bearing	47306V
7	Nachstell Set / boulon set / adjusting set	405859.001
8	Federn Set / traction set / spring set	406001.001
9	Bremsbacken Set / machoires de frein set / brake shoes set	403910.001
10	Radzylinder / cylindre de frein de roue / wheel brake cylindre <b>Ø 25,40 mm links</b>	35395.01
	Radzylinder / cylindre de frein de roue / wheel brake cylindre <b>Ø 25,40 mm rechts</b>	35395.02
11	Stößel / tige-pussoir / tappet links	44589-1.01
	Stößel / tige-pussoir / tappet rechts	44589-1.02
12	Seilzug-Adapter / câble adapter / bowden cable adapter <b>Nirosta gerade</b>	980074.01
13	Seilzug-Adapter / câble adapter / bowden cable adapter <b>Nirosta gekröpft 30°</b>	980077
14	Seilzug / câble / bowden cable <b>(1150/1310) Nirosta</b>	980055.02
	Seilzug / câble / bowden cable <b>(1350/1510) Nirosta</b>	980055.15
	Seilzug / câble / bowden cable <b>(1650/1810) Nirosta</b>	980055.01
	Seilzug / câble / bowden cable <b>(1850/2010) Nirosta</b>	980055.12
	Seilzug / câble / bowden cable <b>(2050/2210) Nirosta</b>	980055.16
	Seilzug / câble / bowden cable <b>(2250/2410) Nirosta</b>	980055.03
15	Verschlußdeckel / couvercle / cover	44569.03
16	Kugelbundschrabe / vis a'embase convexe / spherical collar screw <b>M12</b>	46465.01
	Kugelbundschrabe / vis a'embase convexe / spherical collar screw <b>M14</b>	43777.01
17	Kegelbundschrabe / vis a'embase conique / con collar screw <b>M12</b>	43696-1

# BREMSTYP: 20,32-1647 Avonride

Bremsgröße: 203,2x40 Spr.B.

(Kegelrollenlager)

Pos. 1



Pos. 2



Pos. 3



Pos. 4



Pos. 5



Pos. 6



Pos. 7



Pos. 8



Pos. 9



Pos. 10

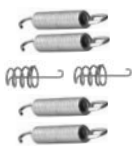

Pos. 11

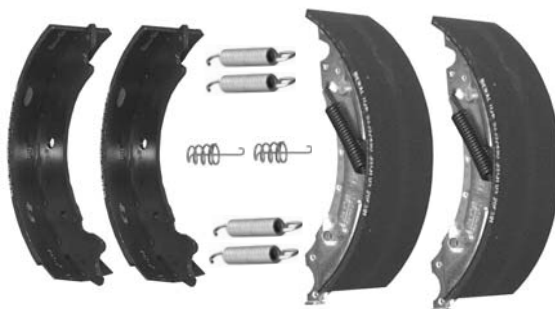

Pos. 12



Pos. 13



Pos. 15



Pos. 17



Pos. 18



Pos. 14



Pos. 16





Das **Original**  
und Sie fahren mit Sicherheit weiter...

Pos	Bezeichnung	Bestell- nummer
1	Bremsnabe / moyeu de frein compl. / brake hub compl. <b>100x4</b>	406156B001
	Bremsnabe / moyeu de frein compl. / brake hub compl. <b>112x5</b>	406156C001
	Bremsnabe / moyeu de frein compl. / brake hub compl. <b>139,7x4</b>	406156K001
2	Kappe / capouchon / cap	406140.001
3	Splint / boulon / spint-pin	D94.014
4	Kronenmutter / écrou crènelè / castle nut	406142.001
5	Scheibe / rondelle / washer	406152.001
6	Kegelrollenlager / roulement à rouleaux coniques / taper roller bearing	406144.001
7	Kegelrollenlager / roulement à rouleaux coniques / taper roller bearing	406147.001
8	Anschlagscheibe / rondelle / washer	406148.001
9	Nachstell Set / boulon set / adjusting set	405859.001
10	Federn Set / traction set / spring set	406163.001
11	Bremsbacken Set / mâchoires de frein set / brake shoes set	38196.01V
12	Spreizschloß kpl. / verrou d'ecartement / spread lever compl.	45309
13	Seilzug / câble / bowden cable ( <b>730/ 940</b> )	33921-1.06
	Seilzug / câble / bowden cable ( <b>830/1040</b> )	33921-1.07
	Seilzug / câble / bowden cable ( <b>1030/1240</b> )	33921-1.11
	Seilzug / câble / bowden cable ( <b>1230/1440</b> )	33921-1.14
	Seilzug / câble / bowden cable ( <b>1430/1640</b> )	33921-1.16
	Seilzug / câble / bowden cable ( <b>1530/1740</b> )	33921-1.17
14	Seilzug / câble / bowden cable ( <b>730/ 940</b> ) <b>Nirosta</b>	37086.06
	Seilzug / câble / bowden cable ( <b>830/1040</b> ) <b>Nirosta</b>	37086.07
	Seilzug / câble / bowden cable ( <b>1030/1240</b> ) <b>Nirosta</b>	37086.11
	Seilzug / câble / bowden cable ( <b>1230/1440</b> ) <b>Nirosta</b>	37086.14
	Seilzug / câble / bowden cable ( <b>1430/1640</b> ) <b>Nirosta</b>	37086.16
	Seilzug / câble / bowden cable ( <b>1530/1740</b> ) <b>Nirosta</b>	37086.17
15	Schale / coquille / shell	36341
16	Zugöse / anneau de couplage / drawbar eye	45207
17	Verschlußdeckel / couvercle / cover	44569.03
18	Kegelbundmutter / écrou a bridge / flanged nut <b>M12</b>	D74361.003

# BREMSTYP: 25-2026

Bremsgröße: 250x40 Spr.  
(Schräggugellager)

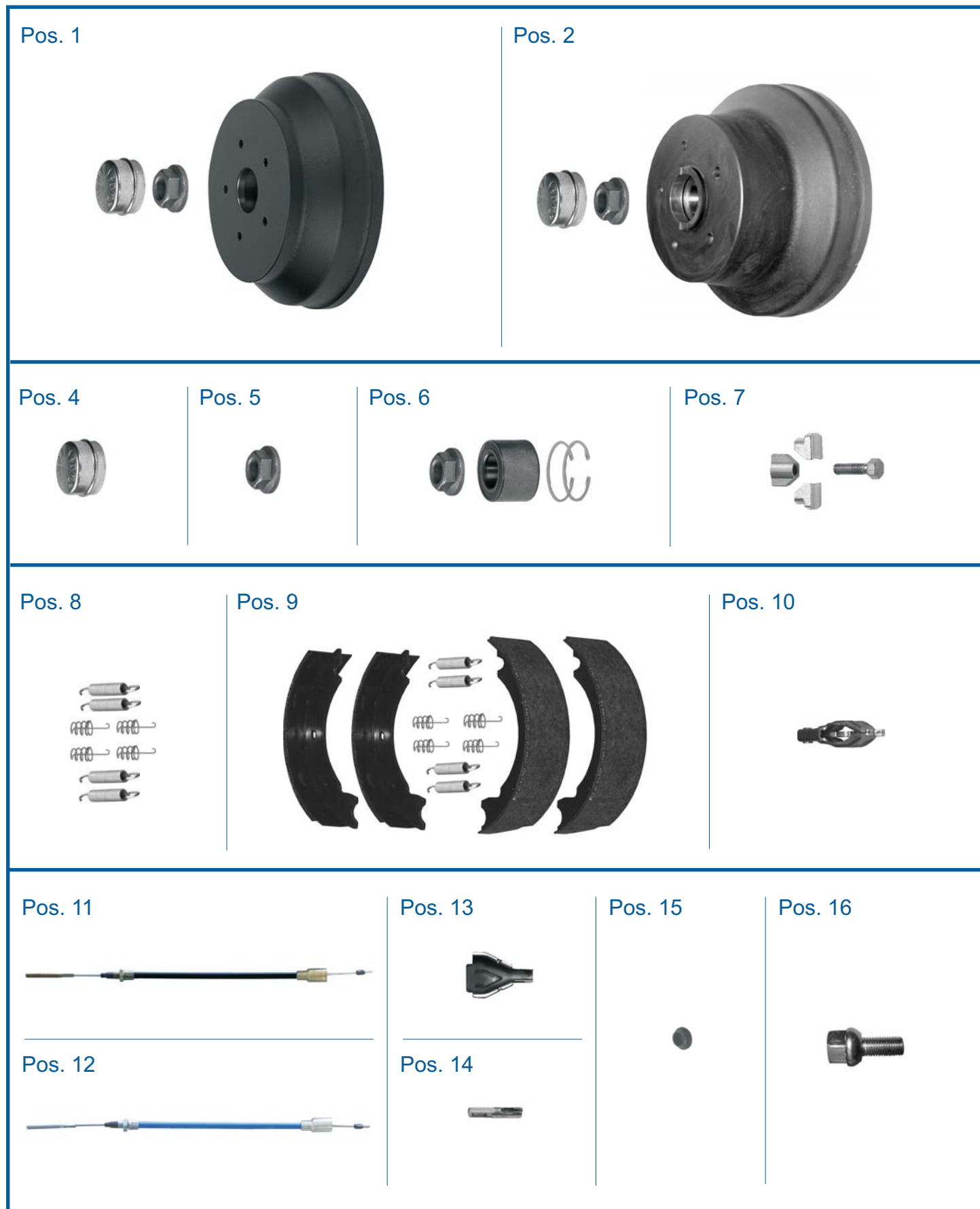

Das **Original**  
und Sie fahren mit Sicherheit weiter...

Pos	Bezeichnung	Bestell- nummer
1	Bremsnabe vollst. 12" / moyeu de frein compl. / brake hub compl. <b>112x5</b>	28748C02
	Bremsnabe vollst. 12" / moyeu de frein compl. / brake hub compl. <b>112x5</b> wasserdicht / étanché / waterproof	28739C02
2	Bremsnabe vollst. 10" / moyeu de frein compl. / brake hub compl. <b>112x5</b>	28749C02
4	Kappe <b>Ø 52,1mm</b> / capouchon / cap	47117
5	Flanschmutter / écrou a'bridge / flanged nut	44738
6	Schräggugellager Set <b>Ø 72mm</b> / roulment a'billes contact oblique / angular ball bearing	47306V
7	Nachstell Set / boulon set / adjusting set	100721
8	Federn Set / traction set / spring set	406002.001
9	Bremsbacken Set / machoires de frein set / brake shoes set	406164.001
10	Spreizschloß kpl. / verrou d'ecartement / spread lever compl.	45309
11	Seilzug / câble / bowden cable ( <b>730/ 940</b> )	33921-1.06
	Seilzug / câble / bowden cable ( <b>830/1040</b> )	33921-1.07
	Seilzug / câble / bowden cable ( <b>1030/1240</b> )	33921-1.11
	Seilzug / câble / bowden cable ( <b>1230/1440</b> )	33921-1.14
	Seilzug / câble / bowden cable ( <b>1430/1640</b> )	33921-1.16
	Seilzug / câble / bowden cable ( <b>1530/1740</b> )	33921-1.17
12	Seilzug / câble / bowden cable ( <b>730/ 940</b> ) <b>Nirosta</b>	37086.06
	Seilzug / câble / bowden cable ( <b>830/1040</b> ) <b>Nirosta</b>	37086.07
	Seilzug / câble / bowden cable ( <b>1030/1240</b> ) <b>Nirosta</b>	37086.11
	Seilzug / câble / bowden cable ( <b>1230/1440</b> ) <b>Nirosta</b>	37086.14
	Seilzug / câble / bowden cable ( <b>1430/1640</b> ) <b>Nirosta</b>	37086.16
	Seilzug / câble / bowden cable ( <b>1530/1740</b> ) <b>Nirosta</b>	37086.17
13	Schale / coquille / shell	36341
14	Zugöse / anneau de couplage / drawbar eye	45207
15	Verschlußdeckel / couvercle / cover	44559.08
16	Kugelbundschrabe / vis a'embase convexe / spherical collar screw <b>M12</b>	46465.01

# BREMSTYP: 25-2025

Bremsgröße: 250x40 Spr. B.  
(Schräggugellager)

Pos. 1



Pos. 2



Pos. 4



Pos. 5



Pos. 6



Pos. 7



Pos. 8

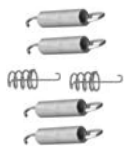

Pos. 9

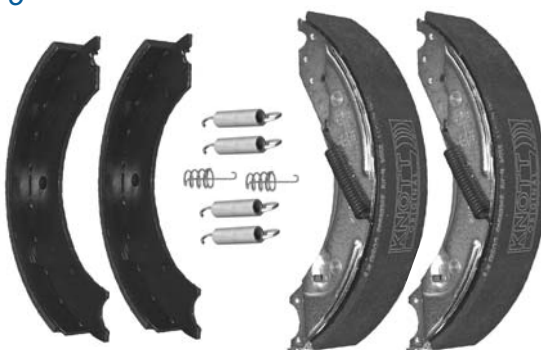

Pos. 10



Pos. 11



Pos. 13



Pos. 15



Pos. 12



Pos. 14



Pos. 16



Das **Original**  
und Sie fahren mit Sicherheit weiter...

Pos	Bezeichnung	Bestell- nummer
1	Bremsnabe vollst. 12" / moyeu de frein compl. / brake hub compl. <b>112x5</b>	28748C02
	Bremsnabe vollst. 12" / moyeu de frein compl. / brake hub compl. <b>112x5</b> wasserdicht / étanché / waterproof	28739C02
2	Bremsnabe vollst. 10" / moyeu de frein compl. / brake hub compl. <b>112x5</b>	28749C02
4	Kappe <b>Ø 52,1mm</b> / capouchon / cap	47117
5	Flanschmutter / écrou a'bridge / flanged nut	44738
6	Schräggugellager Set <b>Ø 72mm</b> / roulment a'billes contact oblique / angular ball bearing	47306V
7	Nachstell Set / boulon set / adjusting set	100721
8	Federn Set / traction set / spring set	400725.001
9	Bremsbacken Set / machoires de frein set / brake shoes set	402677.001
10	Spreizschloß kpl. / verrou d'ecartement / spread lever compl.	45309
11	Seilzug / câble / bowden cable ( <b>730/ 940</b> )	33921-1.06
	Seilzug / câble / bowden cable ( <b>830/1040</b> )	33921-1.07
	Seilzug / câble / bowden cable ( <b>1030/1240</b> )	33921-1.11
	Seilzug / câble / bowden cable ( <b>1230/1440</b> )	33921-1.14
	Seilzug / câble / bowden cable ( <b>1430/1640</b> )	33921-1.16
	Seilzug / câble / bowden cable ( <b>1530/1740</b> )	33921-1.17
12	Seilzug / câble / bowden cable ( <b>730/ 940</b> ) <b>Nirosta</b>	37086.06
	Seilzug / câble / bowden cable ( <b>830/1040</b> ) <b>Nirosta</b>	37086.07
	Seilzug / câble / bowden cable ( <b>1030/1240</b> ) <b>Nirosta</b>	37086.11
	Seilzug / câble / bowden cable ( <b>1230/1440</b> ) <b>Nirosta</b>	37086.14
	Seilzug / câble / bowden cable ( <b>1430/1640</b> ) <b>Nirosta</b>	37086.16
	Seilzug / câble / bowden cable ( <b>1530/1740</b> ) <b>Nirosta</b>	37086.17
13	Schale / coquille / shell	36341
14	Zugöse / anneau de couplage / drawbar eye	45207
15	Verschlußdeckel / couvercle / cover	44559.08
16	Kugelbundschrube / vis a'embase convexe / spherical collar screw <b>M12</b>	46465.01

# BREMSTYP: 25-2025 Avonride

Bremsgröße: 250x40 Spr.B.  
(Kegelrollenlager)

Pos. 1



Pos. 2



Pos. 3



Pos. 4



Pos. 5



Pos. 6



Pos. 7



Pos. 8



Pos. 9



Pos. 10

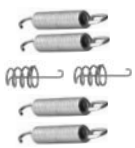

Pos. 11

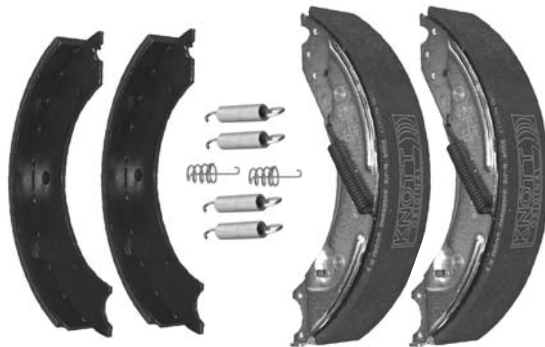

Pos. 12



Pos. 13



Pos. 15



Pos. 17



Pos. 18



Pos. 14



Pos. 16



Das **Original**  
und Sie fahren mit Sicherheit weiter...

Pos	Bezeichnung	Bestell- nummer
	Bremsnabe / moyeu de frein compl. / brake hub compl. <b>112x5</b>	406157C001
	Bremsnabe / moyeu de frein compl. / brake hub compl. <b>165,1x5</b>	406157V001
2	Kappe / capouchon / cap	406141.001
3	Splint / boulon / spint-pin	D94.014
4	Kronenmutter / écrou crènelé / castle nut	406143.001
5	Scheibe / rondelle / washer	406153.001
6	Kegelrollenlager / roulement à rouleaux coniques / taper roller bearing	406149.001
7	Kegelrollenlager / roulement à rouleaux coniques / taper roller bearing	406150.001
8	Anschlagscheibe / rondelle / washer	406151.001
9	Nachstell Set / boulon set / adjusting set	100721
10	Federn Set / traction set / spring set	400725.001
11	Bremsbacken Set / machoires de frein set / brake shoes set	402677.001
12	Spreizschloß kpl. / verrou d'ecartement / spread lever compl.	45309
13	Seilzug / câble / bowden cable ( <b>730/ 940</b> )	33921-1.06
	Seilzug / câble / bowden cable ( <b>830/1040</b> )	33921-1.07
	Seilzug / câble / bowden cable ( <b>1030/1240</b> )	33921-1.11
	Seilzug / câble / bowden cable ( <b>1230/1440</b> )	33921-1.14
	Seilzug / câble / bowden cable ( <b>1430/1640</b> )	33921-1.16
	Seilzug / câble / bowden cable ( <b>1530/1740</b> )	33921-1.17
14	Seilzug / câble / bowden cable ( <b>730/ 940</b> ) <b>Nirosta</b>	37086.06
	Seilzug / câble / bowden cable ( <b>830/1040</b> ) <b>Nirosta</b>	37086.07
	Seilzug / câble / bowden cable ( <b>1030/1240</b> ) <b>Nirosta</b>	37086.11
	Seilzug / câble / bowden cable ( <b>1230/1440</b> ) <b>Nirosta</b>	37086.14
	Seilzug / câble / bowden cable ( <b>1430/1640</b> ) <b>Nirosta</b>	37086.16
	Seilzug / câble / bowden cable ( <b>1530/1740</b> ) <b>Nirosta</b>	37086.17
15	Schale / coquille / shell	36341
16	Zugöse / anneau de couplage / drawbar eye	45207
17	Verschlußdeckel / couvercle / cover	44559.08
18	Kegelbundmutter / écrou a bridge / flanged nut <b>M16</b>	47560

# BREMSTYP: 25-4300

Bremsgröße: 250x40 Hydraulik Simplex  
(Schrägkugellager)





Das **Original**  
und Sie fahren mit Sicherheit weiter...

Pos	Bezeichnung	Bestell- nummer
1	Bremsnabe vollst. 12" / moyeu de frein compl. / brake hub compl. <b>112x5</b>	28748C02
2	Bremsnabe vollst. 10" / moyeu de frein compl. / brake hub compl. <b>112x5</b>	28749C02
4	Kappe <b>Ø 52,1mm</b> / capouchon / cap	47117
5	Flanschmutter / écrou a'bridge / flanged nut	44738
6	Schrägkugellager Set <b>Ø 72mm</b> / roulment a'billes contact oblique / angular ball bearing	47306V
7	Nachstell Set / boulon set / adjusting set	100721
8	Federn Set / traction set / spring set	406003.001
9	Bremsbacken Set / machoires de frein set / brake shoes set	406165.001
10	Radzylinder / cylindre de frein de roue / wheel brake cylindre <b>Ø 25,40 mm</b>	33455
	Radzylinder / cylindre de frein de roue / wheel brake cylindre <b>Ø 19,05 mm</b>	36407
11	Stößel / tige-pussoir / tappet	41861
12	Seilzug-Adapter / câble adapter / bowden cable adapter <b>Nirosta gerade</b>	980073.01
13	Seilzug-Adapter / câble adapter / bowden cable adapter <b>Nirosta gekröpft 30°</b>	980075.01
14	Seilzug / câble / bowden cable <b>(1150/1310) Nirosta</b>	980055.02
	Seilzug / câble / bowden cable <b>(1350/1510) Nirosta</b>	980055.15
	Seilzug / câble / bowden cable <b>(1650/1810) Nirosta</b>	980055.01
	Seilzug / câble / bowden cable <b>(1850/2010) Nirosta</b>	980055.12
	Seilzug / câble / bowden cable <b>(2050/2210) Nirosta</b>	980055.16
	Seilzug / câble / bowden cable <b>(2250/2410) Nirosta</b>	980055.03
15	Verschlußdeckel / couvercle / cover	44559.08
16	Kugelbundschrabe / vis a'embase convexe / spherical collar screw <b>M12</b>	46465.01

# BREMSTYP: 25-4303

Bremsgröße: 250x40 Hydraulik Simplex  
mit automatischer Nachstellung  
(Schrägkugellager)

Pos. 1



Pos. 2



Pos. 4



Pos. 5



Pos. 6



Pos. 7



Pos. 8



Pos. 9



Pos. 10



Pos. 11



Pos. 12



Pos. 13



Pos. 14



Pos. 15



Pos. 16



Pos. 17



Das **Original**  
und Sie fahren mit Sicherheit weiter...

Pos	Bezeichnung	Bestell- nummer
1	Bremsnabe vollst. 12" / moyeu de frein compl. / brake hub compl. <b>112x5</b>	28748C02
2	Bremsnabe vollst. 10" / moyeu de frein compl. / brake hub compl. <b>112x5</b>	28749C02
4	Kappe <b>Ø 52,1mm</b> / capouchon / cap	47117
5	Flanschmutter / écrou a'bridge / flanged nut	44738
6	Schrägkugellager Set <b>Ø 72mm</b> / roulment a'billes contact oblique / angular ball bearing	47306V
7	Sicherungsblech /	46287
8	Deckplatte /	46290
9	Spannstift /	D7346.008
10	Sechskantschraube kpl./ vis a'six pans compl./ hex. bolt compl.	D961.005
11	Bremsbacken Set / mâchoires de frein set / brake shoes set	406166.001
12	Radzylinder / cylindre de frein de roue / wheel brake cylindre <b>Ø 28,57 mm</b>	100210
	Radzylinder / cylindre de frein de roue / wheel brake cylindre <b>Ø 25,40 mm</b>	33455
	Radzylinder / cylindre de frein de roue / wheel brake cylindre <b>Ø 19,05 mm</b>	36407
13	Seilzug-Adapter / câble adapter / bowden cable adapter <b>Nirosta gerade</b>	980073.01
14	Seilzug-Adapter / câble adapter / bowden cable adapter <b>Nirosta gekröpft 30°</b>	980075.01
15	Seilzug / câble / bowden cable <b>(1150/1310) Nirosta</b>	980055.02
	Seilzug / câble / bowden cable <b>(1350/1510) Nirosta</b>	980055.15
	Seilzug / câble / bowden cable <b>(1650/1810) Nirosta</b>	980055.01
	Seilzug / câble / bowden cable <b>(1850/2010) Nirosta</b>	980055.12
	Seilzug / câble / bowden cable <b>(2050/2210) Nirosta</b>	980055.16
	Seilzug / câble / bowden cable <b>(2250/2410) Nirosta</b>	980055.03
16	Verschlussdeckel / couvercle / cover	44559.08
17	Kugelbundschrabe / vis a'embase convexe / spherical collar screw <b>M12</b>	46465.01

# BREMSTYP: 25-4303 / ABS

Bremsgröße: 250x40 Hydraulik Simplex  
mit automatischer Nachstellung  
(Schrägkugellager)

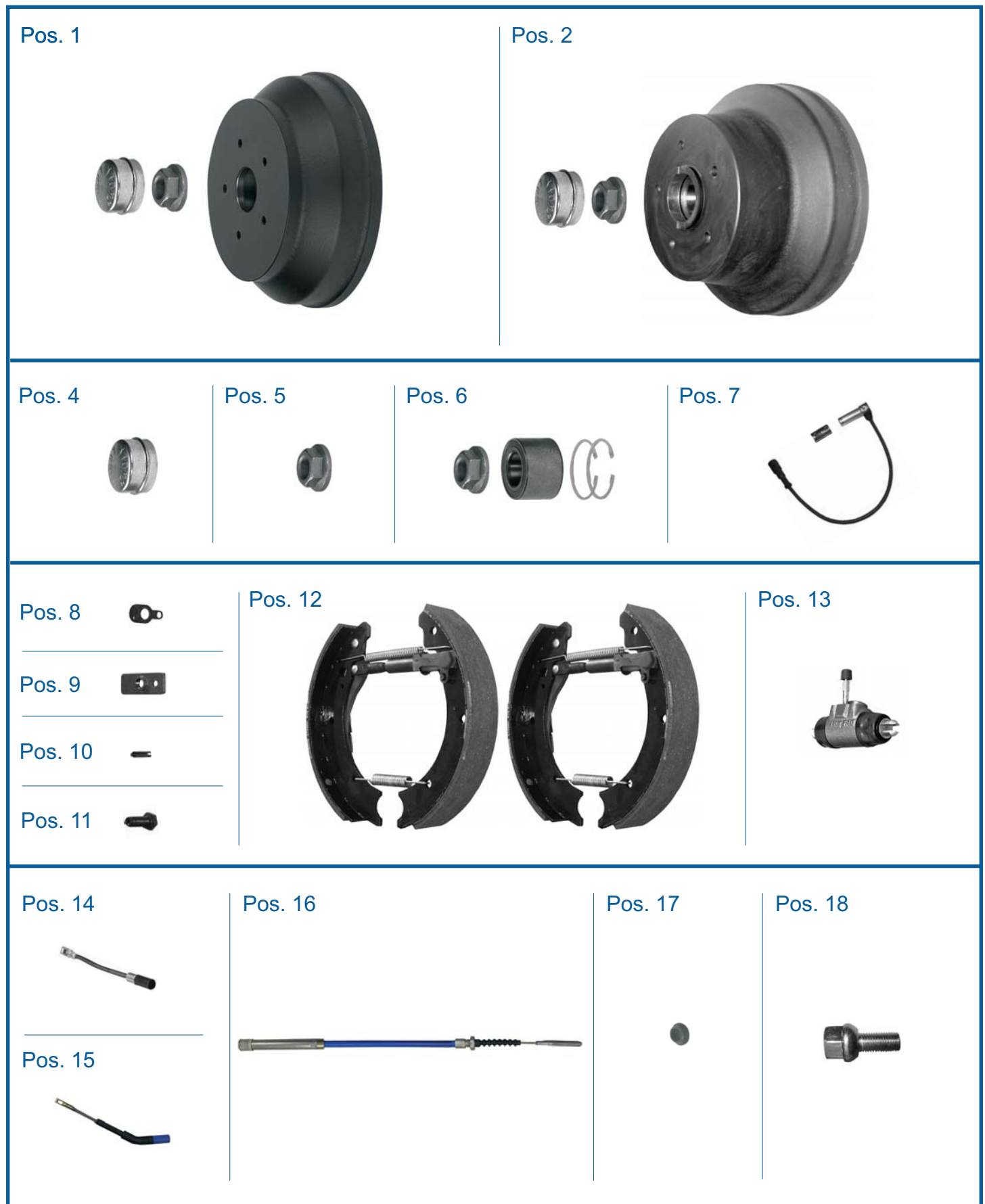

Das **Original**  
und Sie fahren mit Sicherheit weiter...

Pos	Bezeichnung	Bestell- nummer
1	Bremsnabe vollst. 12" / moyeu de frein compl. / brake hub compl. <b>112x5</b> <b>Polrad mit 60 Zähnen</b>	28598C02
	Bremsnabe vollst. 12" / moyeu de frein compl. / brake hub compl. <b>112x5</b> <b>Polrad mit 40 Zähnen</b>	406368C001
2	Bremsnabe vollst. 10" / moyeu de frein compl. / brake hub compl. <b>112x5</b> <b>Polrad mit 60 Zähnen</b>	28750C02
	Bremsnabe vollst. 10" / moyeu de frein compl. / brake hub compl. <b>112x5</b> <b>Polrad mit 34 Zähnen</b>	406369C001
	Bremsnabe vollst. 10" / moyeu de frein compl. / brake hub compl. <b>140x5</b> <b>Polrad mit 34 Zähnen</b>	406369N001
4	Kappe <b>Ø 52,1mm</b> / capouchon / cap	47117
5	Flanschmutter / écrou a'bridge / flanged nut	44738
6	Schräggugellager Set <b>Ø 72mm</b> / roulment a'billes contact oblique / angular ball bearing	47306V
7	ABS-Sensor Set <b>90°</b>	404080.001
	ABS-Sensor Set <b>gerade</b>	404658.001
8	Sicherungsblech /	46287
9	Deckplatte /	46290
10	Spannstift /	D7346.008
11	Sechskantschraube kpl./ vis a'six pans compl./ hex. bolt compl.	D961.005
12	Bremsbacken Set / machoires de frein set / brake shoes set	406166.001
13	Radzylinder / cylindre de frein de roue / wheel brake cylindre <b>Ø 28,57 mm</b>	100210
	Radzylinder / cylindre de frein de roue / wheel brake cylindre <b>Ø 25,40 mm</b>	33455
	Radzylinder / cylindre de frein de roue / wheel brake cylindre <b>Ø 19,05 mm</b>	36407
14	Seilzug-Adapter / câble adapter / bowden cable adapter <b>Nirosta gerade</b>	980073.01
15	Seilzug-Adapter / câble adapter / bowden cable adapter <b>Nirosta gekröpft 30°</b>	980075.01
16	Seilzug / câble / bowden cable <b>(1150/1310) Nirosta</b>	980055.02
	Seilzug / câble / bowden cable <b>(1350/1510) Nirosta</b>	980055.15
	Seilzug / câble / bowden cable <b>(1650/1810) Nirosta</b>	980055.01
	Seilzug / câble / bowden cable <b>(1850/2010) Nirosta</b>	980055.12
	Seilzug / câble / bowden cable <b>(2050/2210) Nirosta</b>	980055.16
	Seilzug / câble / bowden cable <b>(2250/2410) Nirosta</b>	980055.03
17	Verschlussdeckel / couvercle / cover	44559.08
18	Kugelbundschrabe / vis a'embase convexe / spherical collar screw <b>M12</b>	46465.01

# BREMSTYP: 25-4066

Bremsgröße: 250x40 Hydraulik Backmat  
(Schräggugellager)

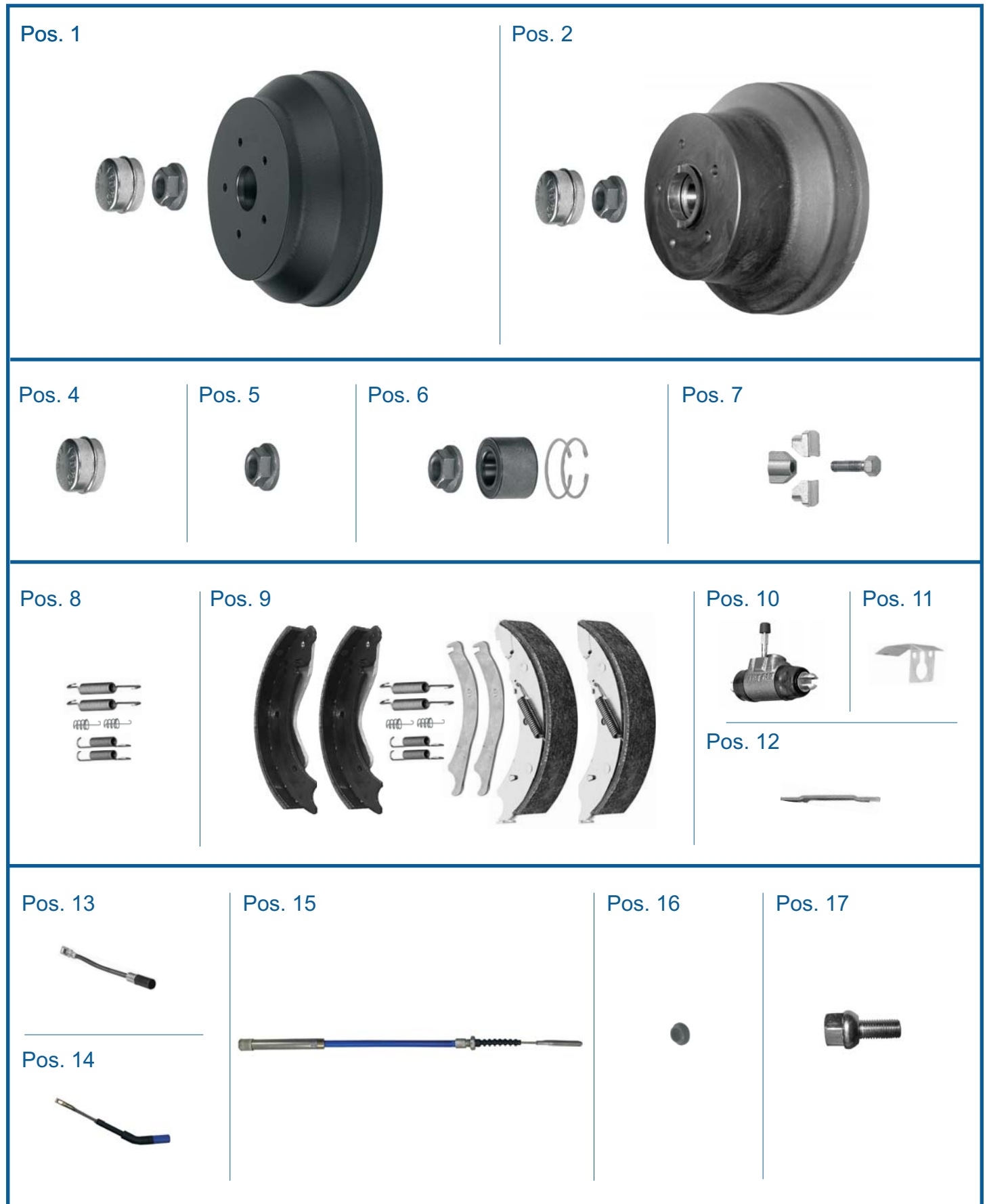

Das **Original**  
und Sie fahren mit Sicherheit weiter...

Pos	Bezeichnung	Bestell- nummer
1	Bremsnabe vollst. 12" / moyeu de frein compl. / brake hub compl. <b>112x5</b>	28748C02
2	Bremsnabe vollst. 10" / moyeu de frein compl. / brake hub compl. <b>112x5</b>	28749C02
4	Kappe <b>Ø 52,1mm</b> / capouchon / cap	47117
5	Flanschmutter / écrou a'bridge / flanged nut	44738
6	Schrägkugellager Set <b>Ø 72mm</b> / roulment a'billes contact oblique / angular ball bearing	47306V
7	Nachstell Set / boulon set / adjusting set	100721
8	Federn Set / traction set / spring set	406004.001
9	Bremsbacken Set / machoires de frein set / brake shoes set	403909.001
10	Radzylinder / cylindre de frein de roue / wheel brake cylindre <b>Ø 28,57 mm links</b>	35746.01
	Radzylinder / cylindre de frein de roue / wheel brake cylindre <b>Ø 28,57 mm rechts</b>	35746.02
11	Schutzblech / tole de protection / shield	46245
12	Stößel / tige-pussoir / tappet <b>links</b>	35767.01
	Stößel / tige-pussoir / tappet <b>rechts</b>	35767.02
13	Seilzug-Adapter / câble adapter / bowden cable adapter <b>Nirosta gerade</b>	980073.01
14	Seilzug-Adapter / câble adapter / bowden cable adapter <b>Nirosta gekröpft 30°</b>	980075.01
15	Seilzug / câble / bowden cable <b>(1150/1310) Nirosta</b>	980055.02
	Seilzug / câble / bowden cable <b>(1350/1510) Nirosta</b>	980055.15
	Seilzug / câble / bowden cable <b>(1650/1810) Nirosta</b>	980055.01
	Seilzug / câble / bowden cable <b>(1850/2010) Nirosta</b>	980055.12
	Seilzug / câble / bowden cable <b>(2050/2210) Nirosta</b>	980055.16
	Seilzug / câble / bowden cable <b>(2250/2410) Nirosta</b>	980055.03
16	Verschlußdeckel / couvercle / cover	44559.08
17	Kugelbundschraube / vis a'embase convexe / spherical collar screw <b>M12</b>	46465.01

# BREMSTYP: 30-2355

Bremsgröße: 300x60 Spr.  
(Kegelrollenlager)

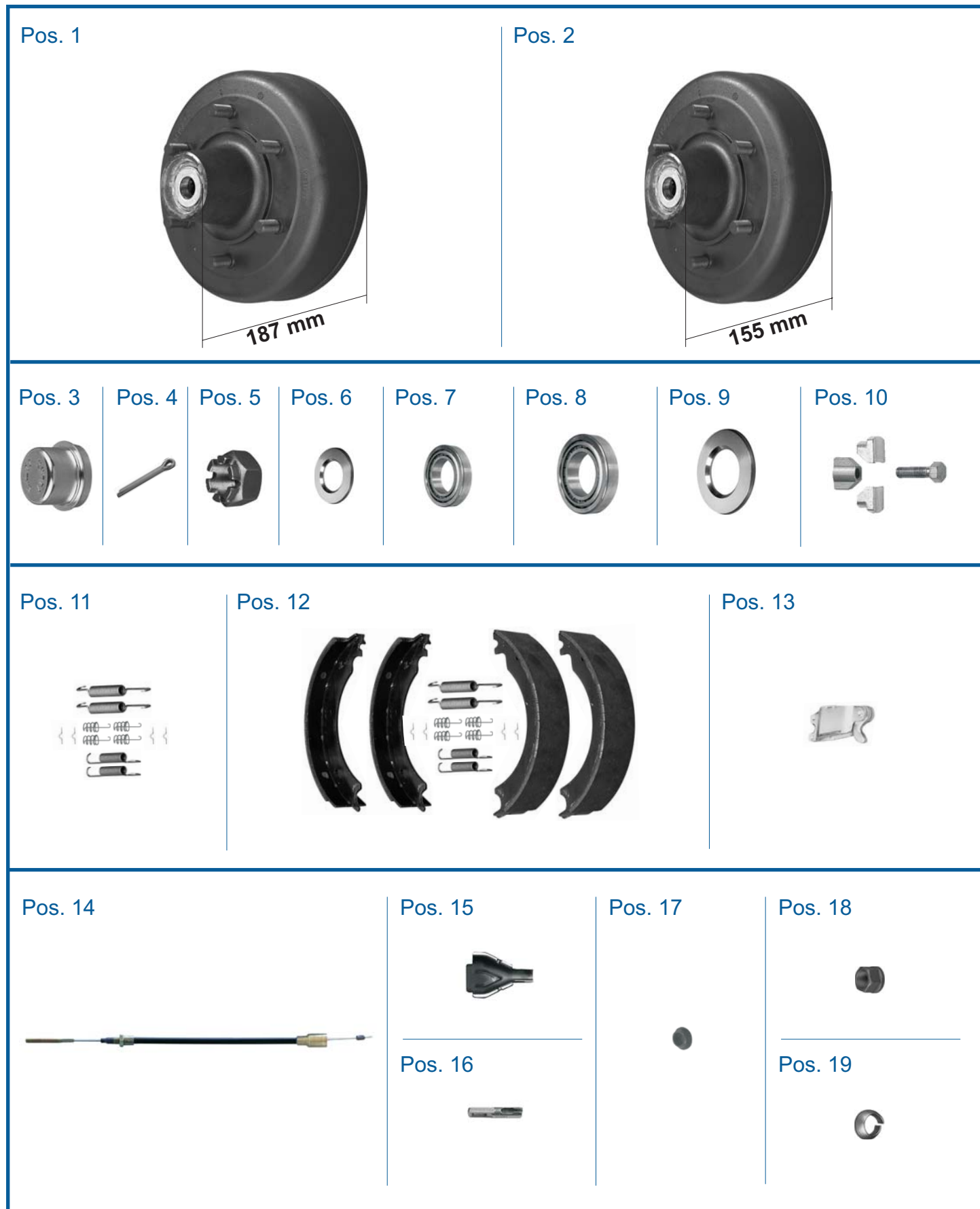



Das **Original**  
und Sie fahren mit Sicherheit weiter...

Pos	Bezeichnung	Bestell- nummer
1	Bremsnabe kpl. / moyeu de frein compl. / brake hub compl. <b>187 mm</b>	25766P02
2	Bremsnabe kpl. / moyeu de frein compl. / brake hub compl. <b>155 mm</b>	28863P02
3	Kappe / capouchon / cap	43299
4	Splint / boulon / spint-pin	D94.019
5	Kronenmutter / écrou crènelé / castle nut	46226.10
6	Scheibe / rondelle / washer	42990
7	Kegelrollenlager / roulement à rouleaux coniques / taper roller bearing	45877.13
8	Kegelrollenlager / roulement à rouleaux coniques / taper roller bearing	45877.17
9	Anschlagscheibe / rondelle / washer	41584
10	Nachstell Set / boulon set / adjusting set	406167.001
11	Federn Set / traction set / spring set	406168.001
12	Bremsbacken Set / mâchoires de frein set / brake shoes set	406169.001
13	Spreizschloß kpl. / verrou d'ecartement / spread lever compl.	43123-1
14	Seilzug / câble / bowden cable ( 700/ 960)	33983-1.02
	Seilzug / câble / bowden cable ( 800/1060)	33983-1.03
	Seilzug / câble / bowden cable ( 900/1160)	33983-1.04
	Seilzug / câble / bowden cable (1000/1260)	33983-1.06
	Seilzug / câble / bowden cable (1100/1360)	33983-1.07
	Seilzug / câble / bowden cable (1200/1460)	33983-1.08
	Seilzug / câble / bowden cable (1300/1560)	33983-1.09
	Seilzug / câble / bowden cable (1400/1660)	33983-1.10
	Seilzug / câble / bowden cable (1600/1860)	33983-1.12
15	Schale / coquille / shell	33623
16	Zugöse / anneau de couplage / drawbar eye	44856
17	Verschlußdeckel / couvercle / cover	44559.11
18	Flachbundmutter / écrou a bridge / flanged nut	D74361.005
19	Federring verz. / rondelle elastique galv. / spring ring zinc-plated	D74361.006

# BREMSTYP: 30-2355

Bremsgröße: 300x60 Spr.  
(Schräggugellager)

Pos. 1



Pos. 2



Pos. 3



Pos. 4



Pos. 5



Pos. 6



Pos. 7



Pos. 8



Pos. 9



Pos. 10



Pos. 12



Pos. 13



Pos. 11



Pos. 14



Das **Original**  
und Sie fahren mit Sicherheit weiter...

Pos	Bezeichnung	Bestell- nummer
1	Bremsnabe kpl. / moyeu de frein compl. / brake hub compl.	406370P001
2	Kappe / capouchon / cap	43299
3	Flanschmutter / écrou a'bridge / flanged nut	46511
4	Schrägkugellager Set / roulment a'billes contact oblique / angular ball bearing	406336.001
5	Nachstell Set / boulon set / adjusting set	406167.001
6	Federn Set / traction set / spring set	406168.001
7	Bremsbacken Set / machoires de frein set / brake shoes set	406169.001
8	Spreizschloß kpl. / verrou d'ecartement / spread lever compl.	43123-1
9	Seilzug / câble / bowden cable ( 700/ 960)	33983-1.02
	Seilzug / câble / bowden cable ( 800/1060)	33983-1.03
	Seilzug / câble / bowden cable ( 900/1160)	33983-1.04
	Seilzug / câble / bowden cable (1000/1260)	33983-1.06
	Seilzug / câble / bowden cable (1100/1360)	33983-1.07
	Seilzug / câble / bowden cable (1200/1460)	33983-1.08
	Seilzug / câble / bowden cable (1300/1560)	33983-1.09
	Seilzug / câble / bowden cable (1400/1660)	33983-1.10
	Seilzug / câble / bowden cable (1600/1860)	33983-1.12
10	Schale / coquille / shell	33623
11	Zugöse / anneau de couplage / drawbar eye	44856
12	Verschlußdeckel / couvercle / cover	44559.11
13	Flachbundmutter / écrou a bridge / flanged nut	D74361.005
14	Federring verz. / rondelle elastique galv. / spring ring zinc-plated	D74361.006

# BREMSTYP: 30-2261

Bremsgröße: 300x60 Spr. B.  
(Kegelrollenlager)

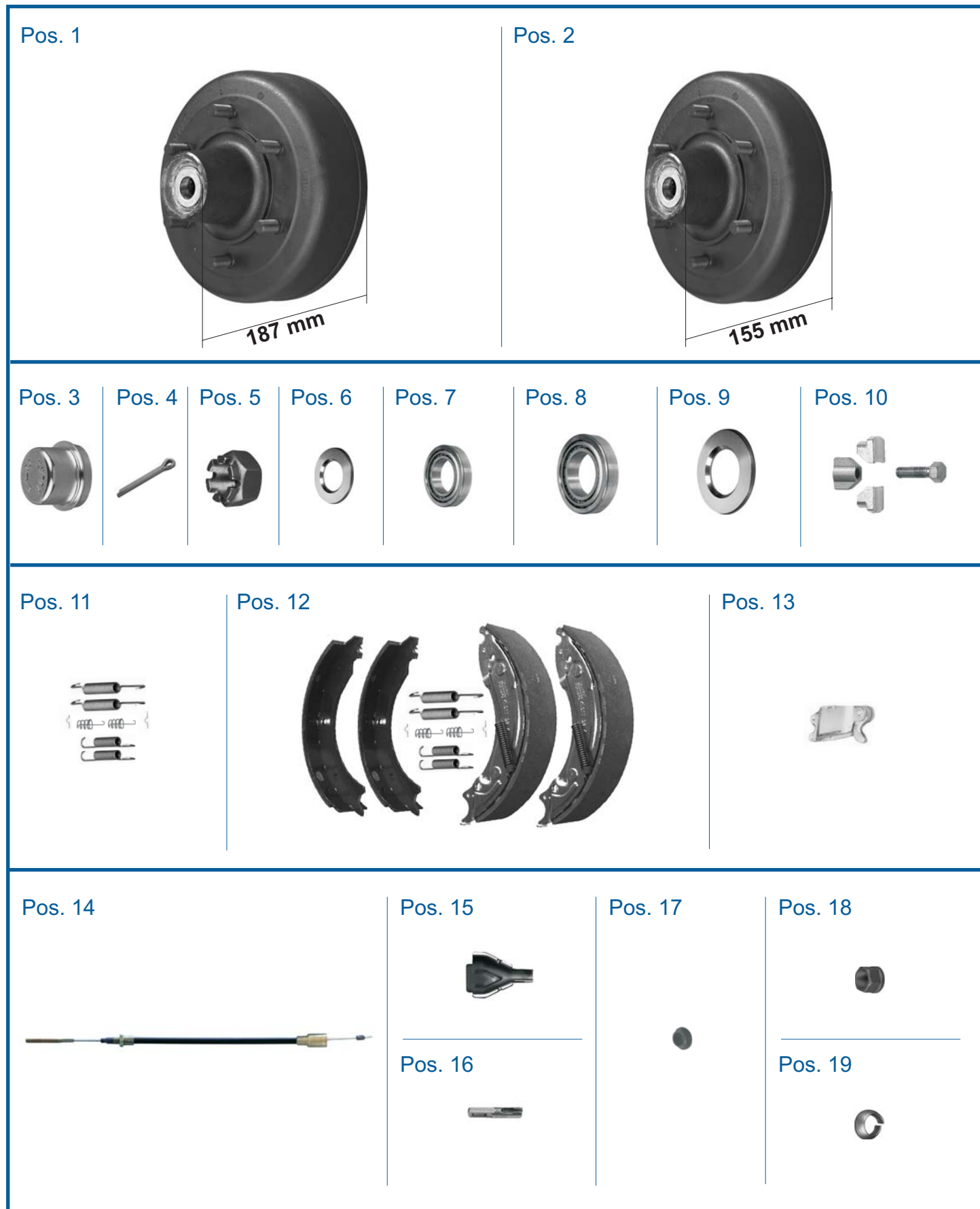

Das **Original**  
und Sie fahren mit Sicherheit weiter...

Pos	Bezeichnung	Bestell- nummer
1	Bremsnabe kpl. / moyeu de frein compl. / brake hub compl. <b>187 mm</b>	25766P02
2	Bremsnabe kpl. / moyeu de frein compl. / brake hub compl. <b>155 mm</b>	28863P02
3	Kappe / capouchon / cap	43299
4	Splint / boulon / spint-pin	D94.019
5	Kronenmutter / écrou crènelé / castle nut	46226.10
6	Scheibe / rondelle / washer	42990
7	Kegelrollenlager / roulement à rouleaux coniques / taper roller bearing	45877.13
8	Kegelrollenlager / roulement à rouleaux coniques / taper roller bearing	45877.17
9	Anschlagscheibe / rondelle / washer	41584
10	Nachstell Set / boulon set / adjusting set	406167.001
11	Federn Set / traction set / spring set	406170.001
12	Bremsbacken Set / mâchoires de frein set / brake shoes set	404115.001
13	Spreizschloß kpl. / verrou d'ecartement / spread lever compl.	43123-1
14	Seilzug / câble / bowden cable ( 700/ 960)	33983-1.02
	Seilzug / câble / bowden cable ( 800/1060)	33983-1.03
	Seilzug / câble / bowden cable ( 900/1160)	33983-1.04
	Seilzug / câble / bowden cable (1000/1260)	33983-1.06
	Seilzug / câble / bowden cable (1100/1360)	33983-1.07
	Seilzug / câble / bowden cable (1200/1460)	33983-1.08
	Seilzug / câble / bowden cable (1300/1560)	33983-1.09
	Seilzug / câble / bowden cable (1400/1660)	33983-1.10
	Seilzug / câble / bowden cable (1600/1860)	33983-1.12
15	Schale / coquille / shell	33623
16	Zugöse / anneau de couplage / drawbar eye	44856
17	Verschlußdeckel / couvercle / cover	44559.11
18	Flachbundmutter / écrou a bridge / flanged nut	D74361.005
19	Federring verz. / rondelle elastique galv. / spring ring zinc-plated	D74361.006

# BREMSTYP: 30-2261

Bremsgröße: 300x60 Spr. B.  
(Schräggugellager)

Pos. 1



Pos. 2



Pos. 3



Pos. 4



Pos. 5



Pos. 6

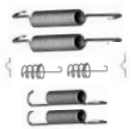

Pos. 7

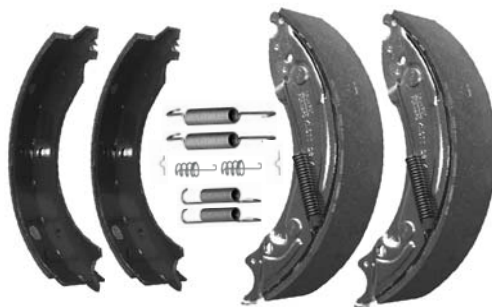

Pos. 8



Pos. 9



Pos. 10



Pos. 12



Pos. 13



Pos. 11



Pos. 14



Das **Original**  
und Sie fahren mit Sicherheit weiter...

Pos	Bezeichnung	Bestell- nummer
1	Bremsnabe kpl. / moyeu de frein compl. / brake hub compl.	406370P001
2	Kappe / capouchon / cap	43299
3	Flanschmutter / écrou a'bridge / flanged nut	46511
4	Schrägkugellager Set / roulment a'billes contact oblique / angular ball bearing	406336.001
5	Nachstell Set / boulon set / adjusting set	406167.001
6	Federn Set / traction set / spring set	406170.001
7	Bremsbacken Set / machoires de frein set / brake shoes set	404115.001
8	Spreizschloß kpl. / verrou d'ecartement / spread lever compl.	43123-1
9	Seilzug / câble / bowden cable ( 700/ 960)	33983-1.02
	Seilzug / câble / bowden cable ( 800/1060)	33983-1.03
	Seilzug / câble / bowden cable ( 900/1160)	33983-1.04
	Seilzug / câble / bowden cable (1000/1260)	33983-1.06
	Seilzug / câble / bowden cable (1100/1360)	33983-1.07
	Seilzug / câble / bowden cable (1200/1460)	33983-1.08
	Seilzug / câble / bowden cable (1300/1560)	33983-1.09
	Seilzug / câble / bowden cable (1400/1660)	33983-1.10
	Seilzug / câble / bowden cable (1600/1860)	33983-1.12
10	Schale / coquille / shell	33623
11	Zugöse / anneau de couplage / drawbar eye	44856
12	Verschlußdeckel / couvercle / cover	44559.11
13	Flachbundmutter / écrou a bridge / flanged nut	D74361.005
14	Federring verz. / rondelle elastique galv. / spring ring zinc-plated	D74361.006

# BREMSTYP: 30-3922

Bremsgröße: 300x60 Hydraulik Simplex  
(Kegelrollenlager)

Pos. 1



Pos. 2



Pos. 3



Pos. 4



Pos. 5



Pos. 6



Pos. 7



Pos. 8



Pos. 9



Pos. 10

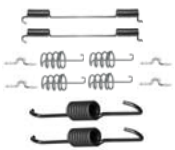

Pos. 11



Pos. 12



Pos. 13



Pos. 14



Pos. 15



Pos. 16



Pos. 17



Pos. 18





Das **Original**  
und Sie fahren mit Sicherheit weiter...

Pos	Bezeichnung	Bestell- nummer
1	Bremsnabe kpl. / moyeu de frein compl. / brake hub compl.	25766P02
2	Kappe / capouchon / cap	43299
3	Splint / boulon / spint-pin	D94.019
4	Kronenmutter / écrou crènelè / castle nut	46226.10
5	Scheibe / rondelle / washer	42990
6	Kegelrollenlager / roulement à rouleaux coniques / taper roller bearing	45877.13
7	Kegelrollenlager / roulement à rouleaux coniques / taper roller bearing	45877.17
8	Anschlagscheibe / rondelle / washer	41584
9	Nachstell Set / boulon set / adjusting set	406167.001
10	Federn Set / traction set / spring set	406171.001
11	Bremsbacken Set / mâchoires de frein set / brake shoes set <b>ohne Feststellung</b>	406172.001
	Bremsbacken Set / mâchoires de frein set / brake shoes set <b>mit Feststellung</b>	406173.001
12	Radzylinder / cylindre de frein de roue / wheel brake cylindre <b>Ø 34,92 mm</b>	36645
	Radzylinder / cylindre de frein de roue / wheel brake cylindre <b>Ø 28,57 mm</b>	36646
	Radzylinder / cylindre de frein de roue / wheel brake cylindre <b>Ø 22,22 mm</b>	36647
13	Stößel / tige-pussoir / tappet	44913
17	Seilzug-Adapter / câble adapter / bowden cable adapter <b>Nirosta gekröpft 30°</b>	980088.06
18	Seilzug / câble / bowden cable <b>(1150/1310) Nirosta</b>	980055.02
	Seilzug / câble / bowden cable <b>(1350/1510) Nirosta</b>	980055.15
	Seilzug / câble / bowden cable <b>(1650/1810) Nirosta</b>	980055.01
	Seilzug / câble / bowden cable <b>(1850/2010) Nirosta</b>	980055.12
	Seilzug / câble / bowden cable <b>(2050/2210) Nirosta</b>	980055.16
	Seilzug / câble / bowden cable <b>(2250/2410) Nirosta</b>	980055.03
19	Verschlußdeckel / couvercle / cover	44559.11
20	Flachbundmutter / écrou a bridge / flanged nut	D74361.005
21	Federring verz. / rondelle elastique galv. / spring ring zinc-plated	D74361.006

# BREMSTYP: 30-4302

Bremsgröße: 300x60 Hydraulik Simplex  
mit automatischer Nachstellung  
(Kegelrollenlager)

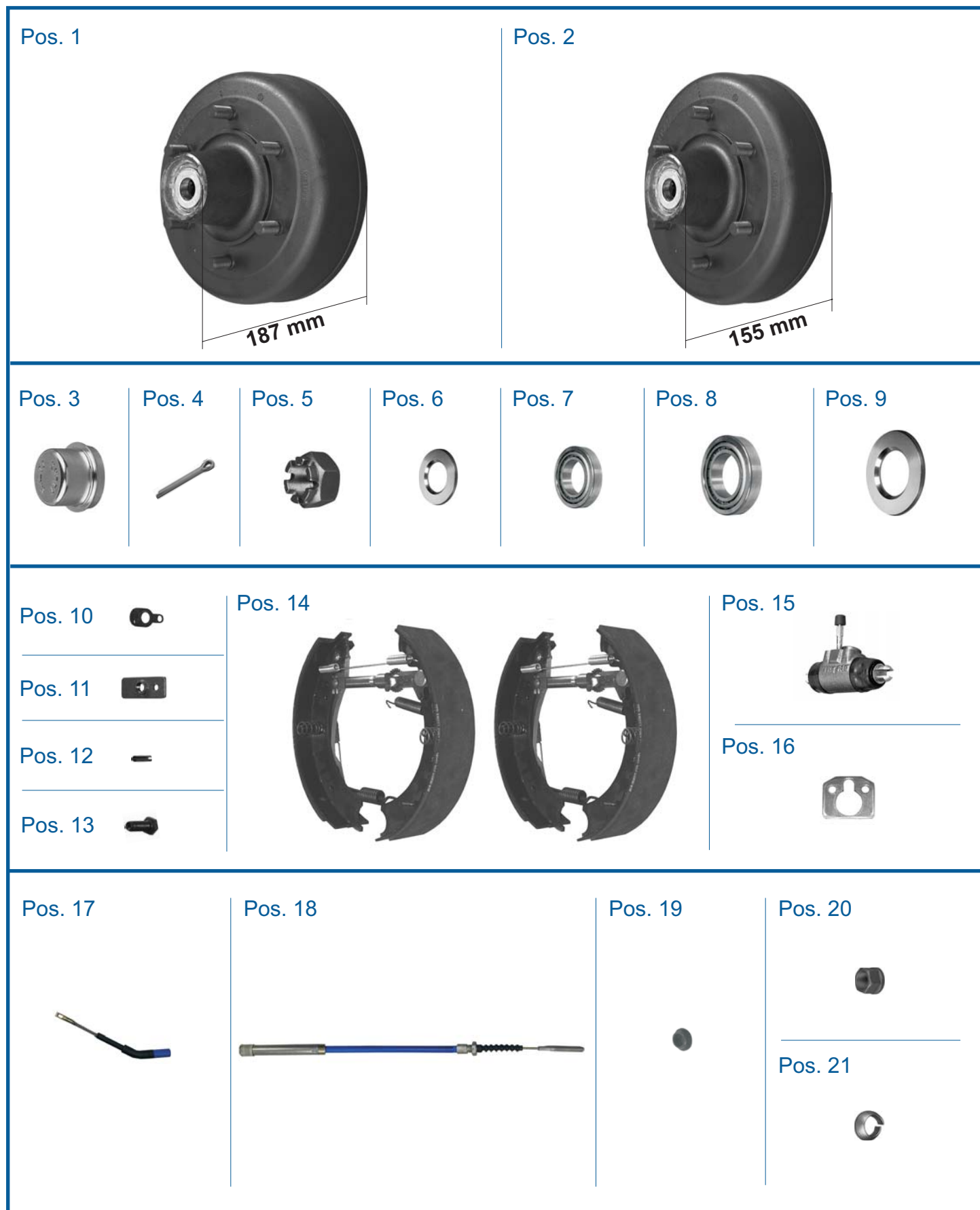

Das **Original**  
und Sie fahren mit Sicherheit weiter...

Pos	Bezeichnung	Bestell- nummer
1	Bremsnabe kpl. / moyeu de frein compl. / brake hub compl. <b>187 mm</b>	25766P02
2	Bremsnabe kpl. / moyeu de frein compl. / brake hub compl. <b>155 mm</b>	28863P02
3	Kappe / capouchon / cap	43299
4	Splint / boulon / spint-pin	D94.019
5	Kronenmutter / écrou crènelé / castle nut	46226.11
6	Scheibe / rondelle / washer	42990
7	Kegelrollenlager / roulement à rouleaux coniques / taper roller bearing	45877.13
8	Kegelrollenlager / roulement à rouleaux coniques / taper roller bearing	45877.17
9	Anschlagscheibe / rondelle / washer	41584
10	Sicherungsblech /	46287
11	Deckplatte /	46290
12	Spannstift /	D7346.008
13	Sechskantschraube kpl./ vis a six pans compl./ hex. bolt compl.	D961.005
14	Bremsbacken Set / mâchoires de frein set / brake shoes set	406174.001
15	Radzylinder / cylindre de frein de roue / wheel brake cylindre <b>Ø 34,92 mm</b>	25394
	Radzylinder / cylindre de frein de roue / wheel brake cylindre <b>Ø 28,57 mm</b>	36638
	Radzylinder / cylindre de frein de roue / wheel brake cylindre <b>Ø 22,22 mm</b>	36639
16	Unterlage /	45028
17	Seilzug-Adapter / câble adapter / bowden cable adapter <b>Nirosta gekröpft 30°</b>	980088.06
18	Seilzug / câble / bowden cable <b>(1150/1310) Nirosta</b>	980055.02
	Seilzug / câble / bowden cable <b>(1350/1510) Nirosta</b>	980055.15
	Seilzug / câble / bowden cable <b>(1650/1810) Nirosta</b>	980055.01
	Seilzug / câble / bowden cable <b>(1850/2010) Nirosta</b>	980055.12
	Seilzug / câble / bowden cable <b>(2050/2210) Nirosta</b>	980055.16
	Seilzug / câble / bowden cable <b>(2250/2410) Nirosta</b>	980055.03
19	Verschlussdeckel / couvercle / cover	44559.11
20	Flachbundmutter / écrou a bridge / flanged nut	D74361.005
21	Federring verz. / rondelle elastique galv. / spring ring zinc-plated	D74361.006

# BREMSTYP: 30-4302

Bremsgröße: 300x60 Hydraulik Simplex  
mit automatischer Nachstellung  
(Schrägkugellager)

Pos. 1



Pos. 2



Pos. 3



Pos. 4



Pos. 5



Pos. 6



Pos. 7



Pos. 8



Pos. 9



Pos. 10



Pos. 11



Pos. 12



Pos. 13



Pos. 14



Pos. 15



Pos. 16



Das **Original**  
und Sie fahren mit Sicherheit weiter...

Pos	Bezeichnung	Bestell- nummer
1	Bremsnabe kpl. / moyeu de frein compl. / brake hub compl.	406370P001
2	Kappe / capouchon / cap	43299
3	Flanschmutter / écrou a'bridge / flanged nut	46511
4	Schrägkugellager Set / roulment a'billes contact oblique / angular ball bearing	406336.001
5	Sicherungsblech /	46287
6	Deckplatte /	46290
7	Spannstift /	D7346.008
8	Sechskantschraube kpl./ vis a'six pans compl./ hex. bolt compl.	D961.005
9	Bremsbacken Set / machoires de frein set / brake shoes set	406174.001
10	Radzylinder / cylindre de frein de roue / wheel brake cylindre <b>Ø 34,92 mm</b>	25394
	Radzylinder / cylindre de frein de roue / wheel brake cylindre <b>Ø 28,57 mm</b>	36638
	Radzylinder / cylindre de frein de roue / wheel brake cylindre <b>Ø 22,22 mm</b>	36639
11	Unterlage /	45028
12	Seilzug-Adapter / câble adapter / bowden cable adapter <b>Nirosta gekröpft 30°</b>	980088.06
13	Seilzug / câble / bowden cable <b>(1150/1310) Nirosta</b>	980055.02
	Seilzug / câble / bowden cable <b>(1350/1510) Nirosta</b>	980055.15
	Seilzug / câble / bowden cable <b>(1650/1810) Nirosta</b>	980055.01
	Seilzug / câble / bowden cable <b>(1850/2010) Nirosta</b>	980055.12
	Seilzug / câble / bowden cable <b>(2050/2210) Nirosta</b>	980055.16
	Seilzug / câble / bowden cable <b>(2250/2410) Nirosta</b>	980055.03
14	Verschlussdeckel / couvercle / cover	44559.11
15	Flachbundmutter / écrou a bridge / flanged nut	D74361.005
16	Federring verz. / rondelle elastique galv. / spring ring zinc-plated	D74361.006

# BREMSTYP: 30-4302 / ABS

Bremsgröße: 300x60 Hydraulik Simplex  
mit automatischer Nachstellung  
(Kegelrollenlager)

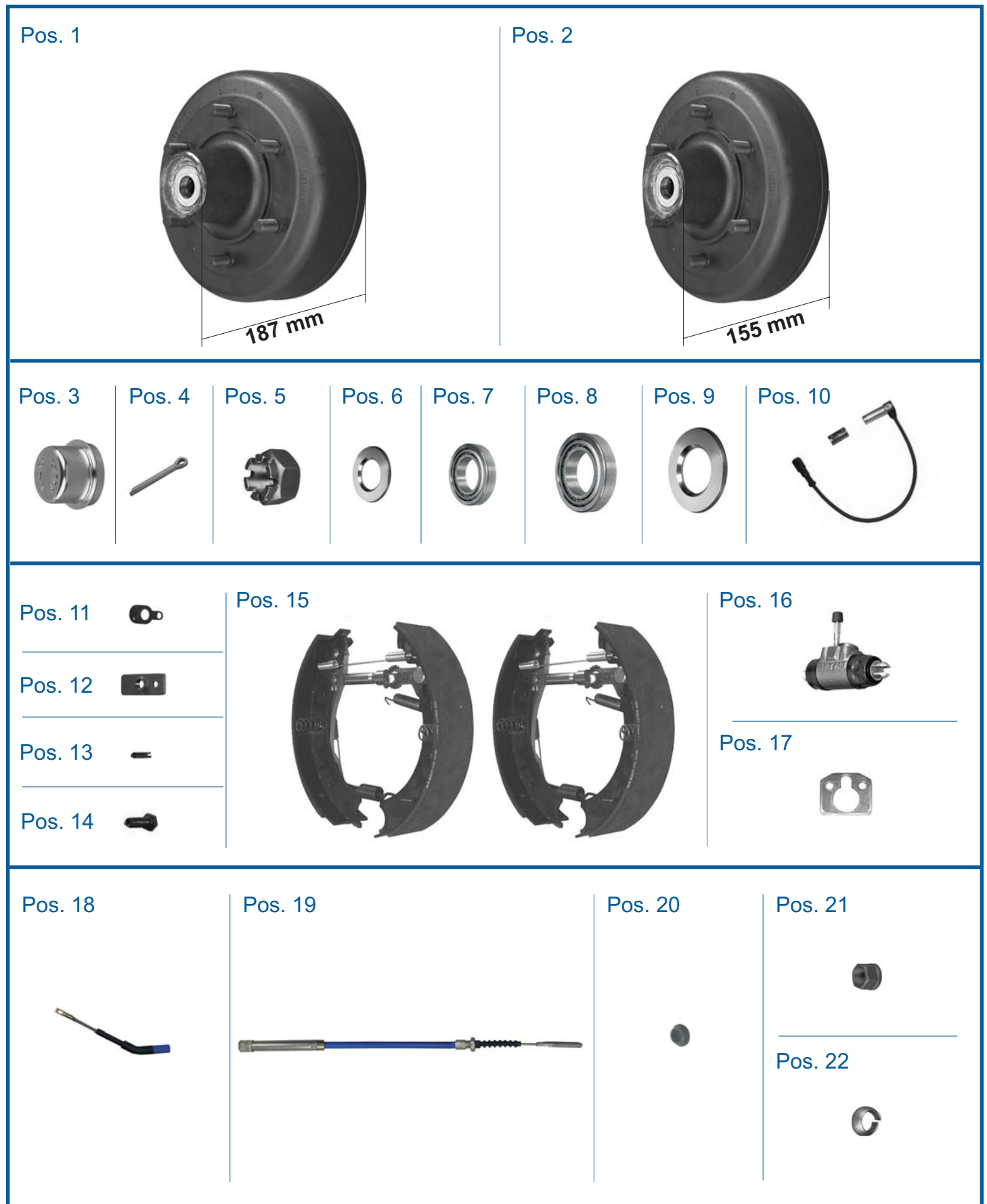

Das **Original**  
und Sie fahren mit Sicherheit weiter...

Pos	Bezeichnung	Bestell- nummer
1	Bremsnabe kpl. / moyeu de frein compl. / brake hub compl. <b>187 mm / Polr. 80 Zähne</b>	27665P02
2	Bremsnabe kpl. / moyeu de frein compl. / brake hub compl. <b>155 mm / Polr. 80 Zähne</b>	29935P02
3	Kappe / capouchon / cap	43299
4	Splint / boulon / spint-pin	D94.019
5	Kronenmutter / écrou crènelè / castle nut	46226.11
6	Scheibe / rondelle / washer	42990
7	Kegelrollenlager / roulement à rouleaux coniques / taper roller bearing	45877.13
8	Kegelrollenlager / roulement à rouleaux coniques / taper roller bearing	45877.17
9	Anschlagscheibe / rondelle / washer	41584
10	ABS-Sensor Set <b>90°</b>	404080.001
	ABS-Sensor Set <b>gerade</b>	404658.001
11	Sicherungsblech /	46287
12	Deckplatte /	46290
13	Spannstift /	D7346.008
14	Sechskantschraube kpl./ vis a'six pans compl./ hex. bolt compl.	D961.005
15	Bremsbacken Set / machoires de frein set / brake shoes set	406174.001
16	Radzylinder / cylindre de frein de roue / wheel brake cylindre <b>Ø 34,92 mm</b>	25394
	Radzylinder / cylindre de frein de roue / wheel brake cylindre <b>Ø 31,80 mm</b>	100327
	Radzylinder / cylindre de frein de roue / wheel brake cylindre <b>Ø 28,57 mm</b>	36638
	Radzylinder / cylindre de frein de roue / wheel brake cylindre <b>Ø 22,22 mm</b>	36639
17	Unterlage /	45028
18	Seilzug-Adapter / câble adapter / bowden cable adapter <b>Nirosta gekröpft 30°</b>	980088.06
19	Seilzug / câble / bowden cable <b>(1150/1310) Nirosta</b>	980055.02
	Seilzug / câble / bowden cable <b>(1350/1510) Nirosta</b>	980055.15
	Seilzug / câble / bowden cable <b>(1650/1810) Nirosta</b>	980055.01
	Seilzug / câble / bowden cable <b>(1850/2010) Nirosta</b>	980055.12
	Seilzug / câble / bowden cable <b>(2050/2210) Nirosta</b>	980055.16
	Seilzug / câble / bowden cable <b>(2250/2410) Nirosta</b>	980055.03
20	Verschlußdeckel / couvercle / cover	44559.11
21	Flachbundmutter / écrou a bridge / flanged nut	D74361.005
22	Federring verz. / rondelle elastique galv. / spring ring zinc-plated	D74361.006

# BREMSTYP: 30-3129

Bremsgröße: 300x60 Nocken  
(Kegelrollenlager)

Pos. 1



Pos. 2



Pos. 3



Pos. 4



Pos. 5



Pos. 6



Pos. 7



Pos. 8



Pos. 9



Pos. 10



Pos. 11



Pos. 12

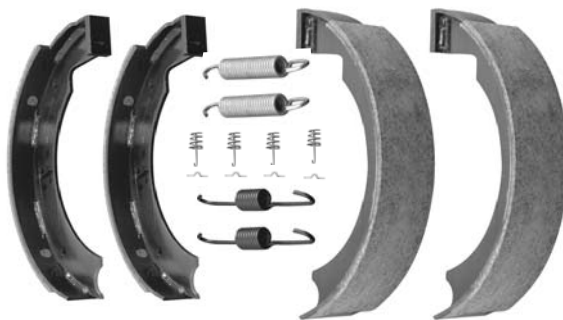

Pos. 13



Pos. 14

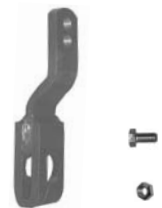

Pos. 15



Pos. 16



Pos. 17



Pos. 18



Pos. 19





Das **Original**  
und Sie fahren mit Sicherheit weiter...

Pos	Bezeichnung	Bestell- nummer
1	Bremsnabe kpl. / moyeu de frein compl. / brake hub compl. <b>187 mm</b>	25766P02
2	Bremsnabe kpl. / moyeu de frein compl. / brake hub compl. <b>155 mm</b>	28863P02
3	Kappe / capouchon / cap	43299
4	Splint / boulon / spint-pin	D94.019
5	Kronenmutter / écrou crènelè / castle nut	46226.11
6	Scheibe / rondelle / washer	42990
7	Kegelrollenlager / roulement à rouleaux coniques / taper roller bearing	45877.13
8	Kegelrollenlager / roulement à rouleaux coniques / taper roller bearing	45877.17
9	Anschlagscheibe / rondelle / washer	41584
10	Nachstell Set / boulon set / adjusting set	406167.001
11	Federn Set / traction set / spring set	406175.001
12	Bremsbacken Set / mâchoires de frein set / brake shoes set	406176.001
13	Bremswelle / càme de frein / brake shaft	45083
14	Bremshebel / levier de frein de parc / parking breake lever <b>rechts</b>	34476.01
	Bremshebel / levier de frein de parc / parking breake lever <b>links</b>	34476.02
15	Buchse / coussinet / bush	35067
16	Buchse / coussinet / bush	42597
17	Seilzug / càble / bowden cable (1460/2000)	33586.07
18	Flachbundmutter / écrou a bridge / flanged nut	D74361.005
19	Federring verz. / rondelle elastique galv. / spring ring zinc-plated	D74361.006

# BREMSTYP: 30-4305

Bremsgröße: 300x60 Nocken  
mit automatischen Gestängesteller  
(Kegelrollenlager)

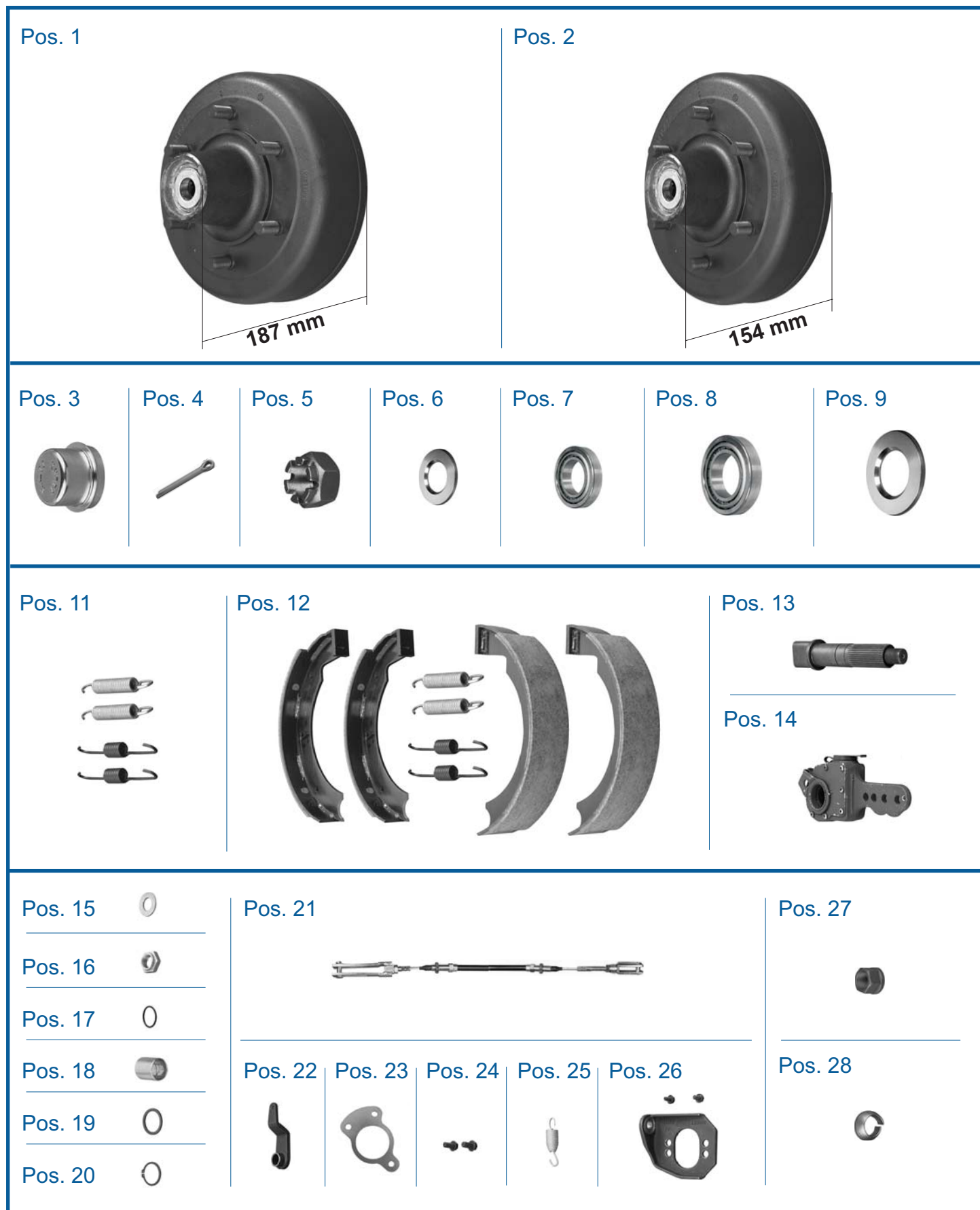

Das **Original**  
und Sie fahren mit Sicherheit weiter...

Pos	Bezeichnung	Bestell- nummer
1	Bremsnabe kpl. / moyeu de frein compl. / brake hub compl. <b>187 mm</b>	25766P02
2	Bremsnabe kpl. / moyeu de frein compl. / brake hub compl. <b>154 mm</b>	27028P02
3	Kappe / capouchon / cap	43299
4	Splint / boulon / spint-pin	D94.019
5	Kronenmutter / écrou crènelè / castle nut	46226.11
6	Scheibe / rondelle / washer	42990
7	Kegelrollenlager / roulement à rouleaux coniques / taper roller bearing	45877.13
8	Kegelrollenlager / roulement à rouleaux coniques / taper roller bearing	45877.17
9	Anschlagscheibe / rondelle / washer	41584
11	Federn Set / traction set / spring set	406177.001
12	Bremsbacken Set / mâchoires de frein set / brake shoes set	406178.001
13	Bremswelle / càmè de frein / brake shaft	38077
14	Auto. Gesängesteller / devier de frein auto. / auto. rod adjuster <b>links</b>	37135.01
	Auto. Gesängesteller / devier de frein auto. / auto. rod adjuster <b>rechts</b>	37135.02
15	Scheibe / rondelle / washer	45966
16	Sicherungsmutter / écrou de blocage / lock nut	46177
17	Runddichtring / joint / o-ring	45068.62
18	Buchse / coussinet / bush	46181
19	Stützscheibe / rondelle / washer	D988.030
20	Sicherungsring / circlips / circlip	D471.021
21	Seilzug / câble / bowden cable (1460/2000)	33586.07
22	Feststellhebel / levier de frein de parc / parking breake lever	38078
23	Formblech / èquerie / shaped	46532
24	Sicherungsschrauben / vis de fixation / safety screw	45872.19
25	Zugfeder / ressort de traction / tension spring	46162
26	Bremszylinderkonsole / cylindre de frein / brake cylinder bracket	25714
27	Flachbundmutter / écrou a bridge / flanged nut	D74361.005
28	Federring verz. / rondelle elastique galv. / spring ring zinc-plated	D74361.006

# BREMSTYP: 30-4305 / ABS

Bremsgröße: 300x60 Nocken  
mit automatischen Gestängesteller  
(Kegelrollenlager)

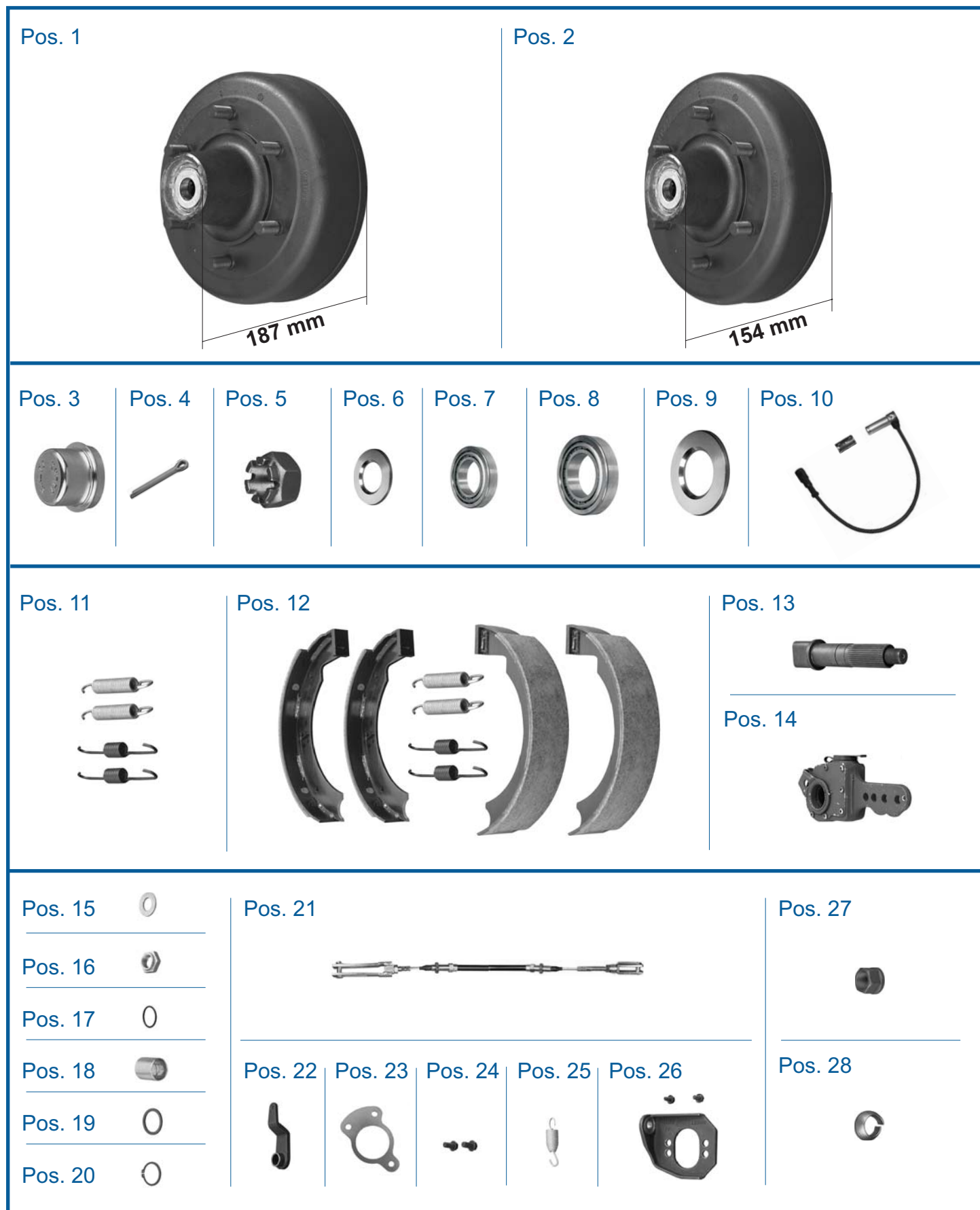

Das **Original**  
und Sie fahren mit Sicherheit weiter...

Pos	Bezeichnung	Bestell- nummer
1	Bremsnabe kpl. / moyeu de frein compl. / brake hub compl. <b>187 mm</b>	13373P01
2	Bremsnabe kpl. / moyeu de frein compl. / brake hub compl. <b>154 mm</b>	28245P01
3	Kappe / capouchon / cap	43299
4	Splint / boulon / spint-pin	D94.019
5	Kronenmutter / écrou crènelé / castle nut	46226.11
6	Scheibe / rondelle / washer	42990
7	Kegelrollenlager / roulement à rouleaux coniques / taper roller bearing	45877.13
8	Kegelrollenlager / roulement à rouleaux coniques / taper roller bearing	45877.17
9	Anschlagscheibe / rondelle / washer	41584
10	ABS-Sensor Set <b>90°</b>	404080.001
11	Federn Set / traction set / spring set	406177.001
12	Bremsbacken Set / mâchoires de frein set / brake shoes set	406178.001
13	Bremswelle / càmè de frein / brake shaft	38077
14	Auto. Gesängesteller / devier de frein auto. / auto. rod adjuster <b>links</b>	37135.01
	Auto. Gesängesteller / devier de frein auto. / auto. rod adjuster <b>rechts</b>	37135.02
15	Scheibe / rondelle / washer	45966
16	Sicherungsmutter / écrou de blocage / lock nut	46177
17	Runddichtring / joint / o-ring	45068.62
18	Buchse / coussinet / bush	46181
19	Stützscheibe / rondelle / washer	D988.030
20	Sicherungsring / circlips / circlip	D471.021
21	Seilzug / câble / bowden cable (1460/2000)	33586.07
22	Feststellhebel / levier de frein de parc / parking breake lever	38078
23	Formblech / èquerie / shaped	46532
24	Sicherungsschrauben / vis de fixation / safety screw	45872.19
25	Zugfeder / ressort de traction / tension spring	46162
26	Bremszylinderkonsole / cylindre de frein / brake cylinder bracket	25714
27	Flachbundmutter / écrou a bridge / flanged nut	D74361.005
28	Federring verz. / rondelle elastique galv. / spring ring zinc-plated	D74361.006

# BREMSTYP: 30-4306 / ABS

Bremsgröße: 300x60 S-Nocken  
mit automatischen Gestängesteller  
(Kegelrollenlager)

Pos. 1



Pos. 2



Pos. 3



Pos. 4



Pos. 5



Pos. 6



Pos. 7



Pos. 8



Pos. 9



Pos. 10



Pos. 13



Pos. 14



Pos. 11



Pos. 15



Pos. 12



Pos. 16



Pos. 23



Pos. 24



Pos. 30



Pos. 17



Pos. 18



Pos. 19



Pos. 20



Pos. 21



Pos. 22



Pos. 25



Pos. 26



Pos. 27



Pos. 28



Pos. 29



Pos. 31



Das **Original**  
und Sie fahren mit Sicherheit weiter...

Pos	Bezeichnung	Bestell- nummer
1	Bremsnabe kpl. / moyeu de frein compl. / brake hub compl. <b>154 mm</b>	403964P002
2	Kappe / capouchon / cap	43299
3	Splint / boulon / spint-pin	D94.019
4	Kronenmutter / écrou crènelé / castle nut	46226.11
5	Scheibe / rondelle / washer	42990
6	Kegelrollenlager / roulement à rouleaux coniques / taper roller bearing	45877.13
7	Kegelrollenlager / roulement à rouleaux coniques / taper roller bearing	45877.17
8	Anschlagscheibe / rondelle / washer	41584
9	ABS-Sensor Set <b>90°</b>	404080.001
10	Federn Set / traction set / spring set	406179.001
11	Abstützplatte /	403542.001
12	Ankerbolzen /	403536.001
13	Bremsbacken Set / mâchoires de frein set / brake shoes set	406180.001
14	Bremswelle / came de frein / brake shaft	38077
15	Auto. Gesängesteller / devier de frein auto. / auto. rod adjuster	403605.001
16	Scheibe / rondelle / washer	45966
17	Sicherungsmutter / écrou de blocage / lock nut	46177
18	V-Ring/ joint / v-ring	404005.020
19	Scheibe / rondelle / washer	403545
20	V-Ring/ joint / v-ring	403681.001
21	Wellendichtring /	403880.001
22	Buchse / coussinet / bush	404587.001
23	Schutzschild /	403543
24	Seilzug / câble / bowden cable (1460/2000)	33586.07
25	Feststellhebel / levier de frein de parc / parking brake lever	38078
26	Mittnehmer /	403547.001
27	Sicherungsschrauben / vis de fixation / safety screw	45982.04
28	Zugfeder / ressort de traction / tension spring	46162
29	Bremszylinderkonsole / cylindre de frein / brake cylinder bracket	25714
	Sicherungsschrauben / vis de fixation / safety screw	45872.19
30	Flachbundmutter / écrou a bridge / flanged nut	D74361.005
31	Federring verz. / rondelle elastique galv. / spring ring zinc-plated	D74361.006

# BREMSTYP: 30-4304

Bremsgröße: 300x80 Spr.  
(Kegelrollenlager)

Pos. 1



Pos. 2



Pos. 3



Pos. 4



Pos. 5



Pos. 6



Pos. 7



Pos. 8



Pos. 9



Pos. 10



Pos. 11



Pos. 12



Pos. 13



Pos. 14



Pos. 16



Pos. 17



Pos. 18



Pos. 19



Pos. 20





Das **Original**  
und Sie fahren mit Sicherheit weiter...

Pos	Bezeichnung	Bestell- nummer
1	Bremsnabe kpl. / moyeu de frein compl. / brake hub compl.	28593P02
2	Kappe / capouchon / cap	43651
3	Splint / boulon / spint-pin	D94.022
4	Kronenmutter / écrou crènelè / castle nut	D935.002
5	Kegelrollenlager / roulement à rouleaux coniques / taper roller bearing	45877.15
6	Kegelrollenlager / roulement à rouleaux coniques / taper roller bearing	45877.21
7	Anschlagscheibe / rondelle / washer	401633
8	Spreizschloß kpl. / verrou d'ecartement / spread lever compl.	34768
9	Federn Set / traction set / spring set	406325.001
10	Bremsbacken Set / machoires de frein set / brake shoes set	406326.001
11	Arretierungshebel kpl. /	45622
12	Sicherungsblech /	34767
13	Nachstellmutter kpl. /	34822
14	Bolzen / boulon / bolt	D1444.001
15	Splint / boulon / spint-pin	D94.011
16	Seilzug / câble / bowden cable ( 700/ 960)	33983-1.02
	Seilzug / câble / bowden cable ( 800/1060)	33983-1.03
	Seilzug / câble / bowden cable ( 900/1160)	33983-1.04
	Seilzug / câble / bowden cable (1000/1260)	33983-1.06
	Seilzug / câble / bowden cable (1100/1360)	33983-1.07
	Seilzug / câble / bowden cable (1200/1460)	33983-1.08
	Seilzug / câble / bowden cable (1300/1560)	33983-1.09
	Seilzug / câble / bowden cable (1400/1660)	33983-1.10
	Seilzug / câble / bowden cable (1600/1860)	33983-1.12
17	Schale / coquille / shell	33623
18	Zugöse / anneau de couplage / drawbar eye	44856
19	Flachbundmutter / écrou a bridge / flanged nut	D74361.005
20	Federring verz. / rondelle elastique galv. / spring ring zinc-plated	D74361.006

# BREMSTYP: 30-3859

Bremsgröße: 300x80 Spr. Rückmatik  
(Kegelrollenlager)

Pos. 1



Pos. 2



Pos. 3



Pos. 4



Pos. 5



Pos. 6



Pos. 7



Pos. 8



Pos. 9



Pos. 10



Pos. 11



Pos. 13



Pos. 12



Pos. 14



Pos. 15



Pos. 16



Pos. 17



Pos. 18



Pos. 19



Pos. 20



Pos. 21



Pos. 22



Pos. 23



Das **Original**  
und Sie fahren mit Sicherheit weiter...

Pos	Bezeichnung	Bestell- nummer
1	Bremsnabe kpl. / moyeu de frein compl. / brake hub compl.	28593P02
2	Kappe / capouchon / cap	43651
3	Splint / boulon / spint-pin	D94.022
4	Kronenmutter / écrou crènelè / castle nut	D935.002
5	Kegelrollenlager / roulement à rouleaux coniques / taper roller bearing	45877.15
6	Kegelrollenlager / roulement à rouleaux coniques / taper roller bearing	45877.21
7	Anschlagscheibe / rondelle / washer	47335
8	Spreizschloß kpl. / verrou d'ecartement / spread lever compl.	34768
9	Federn Set / traction set / spring set	406327.001
10	Bremsbacken Set / machoires de frein set / brake shoes set	406328.001
11	Rückmatic-Hebel kpl. /	35391
12	Sicherungsblech /	34767
13	Feststellklinke /	34764
14	Nachstellmutter kpl. /	34822
15	Bolzen / boulon / bolt	D1444.001
16	Splint / boulon / spint-pin	D94.011
17	Zylinderschraube /	45318
18	Sechskantmutter /	D6924.001
19	Seilzug / câble / bowden cable ( 700/ 960)	33983-1.02
	Seilzug / câble / bowden cable ( 800/1060)	33983-1.03
	Seilzug / câble / bowden cable ( 900/1160)	33983-1.04
	Seilzug / câble / bowden cable (1000/1260)	33983-1.06
	Seilzug / câble / bowden cable (1100/1360)	33983-1.07
	Seilzug / câble / bowden cable (1200/1460)	33983-1.08
	Seilzug / câble / bowden cable (1300/1560)	33983-1.09
	Seilzug / câble / bowden cable (1400/1660)	33983-1.10
	Seilzug / câble / bowden cable (1600/1860)	33983-1.12
20	Schale / coquille / shell	33623
21	Zugöse / anneau de couplage / drawbar eye	44856
22	Flachbundmutter / écrou a bridge / flanged nut	D74361.005
23	Federring verz. / rondelle elastique galv. / spring ring zinc-plated	D74361.006

# BREMSTYP: 30-1605/1

Bremsgröße: 300x120 Nocken  
mit automatischen Gestängesteller  
(Kegelrollenlager)

Pos. 1



Pos. 2



Pos. 3



Pos. 4



Pos. 5



Pos. 6



Pos. 7



Pos. 8



Pos. 9



Pos. 10



Pos. 12



Pos. 13



Pos. 11



Pos. 14



Pos. 15



Pos. 16



Pos. 17



Pos. 18



Pos. 19



Pos. 20



Pos. 21



Pos. 22



Pos. 23



Pos. 24



Pos. 25



Pos. 26



Das **Original**  
und Sie fahren mit Sicherheit weiter...

Pos	Bezeichnung	Bestell- nummer
1	Bremsnabe kpl. / moyeu de frein compl. / brake hub compl.	13651P01
2	Kappe / capouchon / cap	43651
3	Splint / boulon / spint-pin	D94.022
4	Kronenmutter / écrou crènelè / castle nut	D935.002
5	Kegelrollenlager / roulement à rouleaux coniques / taper roller bearing	45877.15
6	Kegelrollenlager / roulement à rouleaux coniques / taper roller bearing	45877.21
7	Anschlagscheibe / rondelle / washer	46279
8	Zugfeder / traction / spring	42708.02
9	Bremsbacke / machoires de frein / brake shoes	21109.1.01
10	Bremsbelag	31675A.01
11	Niet	D7338.008
12	Bremswelle / càmè de frein / brake shaft	38076
13	Auto. Gesängesteller / devier de frein auto. / auto. rod adjuster <b>links</b>	37135.01
	Auto. Gesängesteller / devier de frein auto. / auto. rod adjuster <b>rechts</b>	37135.02
14	Scheibe / rondelle / washer	45966
15	Sicherungsmutter / écrou de blocage / lock nut	46177
16	Runddichtring / joint / o-ring	45068.62
17	Buchse / coussinet / bush	46371
18	Stützscheibe / rondelle / washer	D988.030
19	Sicherungsring / circlips / circlip	D471.021
20	Seilzug / câble / bowden cable (1460/2000)	33586.07
21	Feststellhebel / levier de frein de parc / parking breake lever	38078
22	Sicherungsschrauben / vis de fixation / safety screw	45872.19
23	Zugfeder / ressort de traction / tension spring	46162
24	Bremszylinderkonsole / cylindre de frein / brake cylinder bracket	29691
25	Flachbundmutter / écrou a bridge / flanged nut	D74361.005
26	Federring verz. / rondelle elastique galv. / spring ring zinc-plated	D74361.006

# BREMSTYP: 30-1605/1 / ABS

Bremsgröße: 300x120 Nocken  
mit automatischen Gestängesteller  
(Kegelrollenlager)

Pos. 1



Pos. 2



Pos. 3



Pos. 4



Pos. 5



Pos. 6



Pos. 7



Pos. 8



Pos. 9



Pos. 10



Pos. 11



Pos. 13



Pos. 14



Pos. 12



Pos. 15



Pos. 16



Pos. 17



Pos. 18



Pos. 19



Pos. 20



Pos. 21



Pos. 22



Pos. 23



Pos. 24



Pos. 25



Pos. 26



Pos. 27



Das **Original**  
und Sie fahren mit Sicherheit weiter...

Pos	Bezeichnung	Bestell- nummer
1	Bremsnabe kpl. / moyeu de frein compl. / brake hub compl.	SK2833
2	Kappe / capouchon / cap	43651
3	Splint / boulon / spint-pin	D94.022
4	Kronenmutter / écrou crènelè / castle nut	D935.002
5	Kegelrollenlager / roulement à rouleaux coniques / taper roller bearing	45877.15
6	Kegelrollenlager / roulement à rouleaux coniques / taper roller bearing	45877.21
7	Anschlagscheibe / rondelle / washer	46279
8	ABS-Sensor Set <b>90°</b>	404080.001
9	Zugfeder / traction / spring	42708.02
10	Bremsbacke / mâchoires de frein / brake shoes	21109.1.01
11	Bremsbelag	31675A.01
12	Niet	D7338.008
13	Bremswelle / càmè de frein / brake shaft	38076
14	Auto. Gesängesteller / devier de frein auto. / auto. rod adjuster <b>links</b>	37135.01
	Auto. Gesängesteller / devier de frein auto. / auto. rod adjuster <b>rechts</b>	37135.02
15	Scheibe / rondelle / washer	45966
16	Sicherungsmutter / écrou de blocage / lock nut	46177
17	Runddichtring / joint / o-ring	45068.62
18	Buchse / coussinet / bush	46371
19	Stützscheibe / rondelle / washer	D988.030
20	Sicherungsring / circlips / circlip	D471.021
21	Seilzug / câble / bowden cable (1460/2000)	33586.07
22	Feststellhebel / levier de frein de parc / parking breake lever	38078
23	Sicherungsschrauben / vis de fixation / safety screw	45872.19
24	Zugfeder / ressort de traction / tension spring	46162
25	Bremszylinderkonsole / cylindre de frein / brake cylinder bracket	29691
26	Flachbundmutter / écrou a bridge / flanged nut	D74361.005
27	Federring verz. / rondelle elastique galv. / spring ring zinc-plated	D74361.006

# BREMSTYP: 30-4307

Bremsgröße: 300x120 S-Nocken  
mit automatischen Gestängesteller  
(Kegelrollenlager)

Pos. 1



Pos. 2



Pos. 3



Pos. 4



Pos. 5



Pos. 6



Pos. 7



Pos. 9



Pos. 12



Pos. 13



Pos. 10



Pos. 14



Pos. 11



Pos. 15



Pos. 22



Pos. 23



Pos. 29



Pos. 16



Pos. 17



Pos. 18



Pos. 19



Pos. 20



Pos. 24



Pos. 25



Pos. 26



Pos. 27



Pos. 28



Pos. 30



Pos. 21





Das **Original**  
und Sie fahren mit Sicherheit weiter...

Pos	Bezeichnung	Bestell- nummer
1	Bremsnabe kpl. / moyeu de frein compl. / brake hub compl.	13651P01
2	Kappe / capouchon / cap	43651
3	Splint / boulon / spint-pin	D94.022
4	Kronenmutter / écrou crènelé / castle nut	46226.12
5	Kegelrollenlager / roulement à rouleaux coniques / taper roller bearing	45877.15
6	Kegelrollenlager / roulement à rouleaux coniques / taper roller bearing	45877.21
7	Anschlagscheibe / rondelle / washer	46279
9	Federn Set / traction set / spring set	406329.001
10	Abstützplatte /	403771.001
11	Ankerbolzen /	403772.001
12	Bremsbacken Set / mâchoires de frein set / brake shoes set	406330.001
13	Bremswelle / càmè de frein / brake shaft	403768.001
14	Auto. Gesängesteller / devier de frein auto. / auto. rod adjuster	403605.001
15	Scheibe / rondelle / washer	45966
16	Sicherungsmutter / écrou de blocage / lock nut	46177
17	V-Ring/ joint / v-ring	404005.020
18	Scheibe / rondelle / washer	403545
19	V-Ring/ joint / v-ring	403681.001
20	Wellendichtring /	403880.001
21	Buchse / coussinet / bush	403985.001
22	Schutzschild /	404087.001
	Schutzschild /	404087.002
23	Seilzug / câble / bowden cable (1460/2000)	33586.07
24	Feststellhebel / levier de frein de parc / parking breake lever	38078
25	Mittnehmer /	403547.001
26	Sicherungsschrauben / vis de fixation / safety screw	45982.04
27	Zugfeder / ressort de traction / tension spring	46162
28	Bremszylinderkonsole / cylindre de frein / brake cylinder bracket	29691
	Sicherungsschrauben / vis de fixation / safety screw	45872.19
29	Flachbundmutter / écrou a bridge / flanged nut	D74361.005
30	Federring verz. / rondelle elastique galv. / spring ring zinc-plated	D74361.006

# BREMSTYP: 30-4307 / ABS

Bremsgröße: 300x120 S-Nocken  
mit automatischen Gestängesteller  
(Kegelrollenlager)

Pos. 1



Pos. 2



Pos. 3



Pos. 4



Pos. 5



Pos. 6



Pos. 7



Pos. 8



Pos. 9



Pos. 12



Pos. 13



Pos. 10



Pos. 14



Pos. 11



Pos. 15



Pos. 22



Pos. 23



Pos. 29



Pos. 16



Pos. 17



Pos. 18



Pos. 19



Pos. 20



Pos. 24



Pos. 25



Pos. 26



Pos. 27



Pos. 28



Pos. 30



Pos. 21



Das **Original**  
und Sie fahren mit Sicherheit weiter...

Pos	Bezeichnung	Bestell- nummer
1	Bremsnabe kpl. / moyeu de frein compl. / brake hub compl.	403602P002
2	Kappe / capouchon / cap	43651
3	Splint / boulon / spint-pin	D94.022
4	Kronenmutter / écrou crènelé / castle nut	46226.12
5	Kegelrollenlager / roulement à rouleaux coniques / taper roller bearing	45877.15
6	Kegelrollenlager / roulement à rouleaux coniques / taper roller bearing	45877.21
7	Anschlagscheibe / rondelle / washer	46279
8	ABS-Sensor Set <b>90°</b>	404080.001
9	Federn Set / traction set / spring set	406329.001
10	Abstützplatte /	403771.001
11	Ankerbolzen /	403772.001
12	Bremsbacken Set / mâchoires de frein set / brake shoes set	406330.001
13	Bremswelle / càmè de frein / brake shaft	403768.001
14	Auto. Gesängesteller / devier de frein auto. / auto. rod adjuster	403605.001
15	Scheibe / rondelle / washer	45966
16	Sicherungsmutter / écrou de blocage / lock nut	46177
17	V-Ring/ joint / v-ring	404005.020
18	Scheibe / rondelle / washer	403545
19	V-Ring/ joint / v-ring	403681.001
20	Wellendichtring /	403880.001
21	Buchse / coussinet / bush	403985.001
22	Schutzschild /	404087.001
	Schutzschild /	404087.002
23	Seilzug / câble / bowden cable (1460/2000)	33586.07
24	Feststellhebel / levier de frein de parc / parking breake lever	38078
25	Mittnehmer /	403547.001
26	Sicherungsschrauben / vis de fixation / safety screw	45982.04
27	Zugfeder / ressort de traction / tension spring	46162
28	Bremszylinderkonsole / cylindre de frein / brake cylinder bracket	29691
	Sicherungsschrauben / vis de fixation / safety screw	45872.19
29	Flachbundmutter / écrou a bridge / flanged nut	D74361.005
30	Federring verz. / rondelle elastique galv. / spring ring zinc-plated	D74361.006

# BREMSTYP: 32,5-1082

Bremsgröße: 325x80 Spr.  
(Kegelrollenlager)

Pos. 1



Pos. 2



Pos. 3



Pos. 4



Pos. 5



Pos. 6



Pos. 7



Pos. 8



Pos. 9

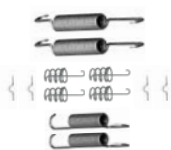

Pos. 10



Pos. 11



Pos. 12



Pos. 13



Pos. 15



Pos. 16



Pos. 14



Pos. 17



Das **Original**  
und Sie fahren mit Sicherheit weiter...

Pos	Bezeichnung	Bestell- nummer
1	Bremsnabe kpl. / moyeu de frein compl. / brake hub compl.	27048P02
2	Kappe / capouchon / cap	43651
3	Splint / boulon / spint-pin	D94.022
4	Kronenmutter / écrou crènelè / castle nut	D935.002
5	Kegelrollenlager / roulement à rouleaux coniques / taper roller bearing	45877.19
6	Kegelrollenlager / roulement à rouleaux coniques / taper roller bearing	45877.21
7	Anschlagscheibe / rondelle / washer	32604
8	Nachstell Set / boulon set / adjusting set	406333.001
9	Federn Set / traction set / spring set	406334.001
10	Bremsbacken Set / mâchoires de frein set / brake shoes set	406335.001
11	Spreizschloß kpl. / verrou d'ecartement / spread lever compl.	43123-1
12	Seilzug / câble / bowden cable ( 700/ 960)	33983-1.02
	Seilzug / câble / bowden cable ( 800/1060)	33983-1.03
	Seilzug / câble / bowden cable ( 900/1160)	33983-1.04
	Seilzug / câble / bowden cable (1000/1260)	33983-1.06
	Seilzug / câble / bowden cable (1100/1360)	33983-1.07
	Seilzug / câble / bowden cable (1200/1460)	33983-1.08
	Seilzug / câble / bowden cable (1300/1560)	33983-1.09
	Seilzug / câble / bowden cable (1400/1660)	33983-1.10
	Seilzug / câble / bowden cable (1600/1860)	33983-1.12
13	Schale / coquille / shell	33623
14	Zugöse / anneau de couplage / drawbar eye	44856
15	Verschlußdeckel / couvercle / cover	44559.11
16	Flachbundmutter / écrou a bridge / flanged nut	D74361.005
17	Federring verz. / rondelle elastique galv. / spring ring zinc-plated	D74361.006

# BREMSTYP: 32,5-4301

Bremsgröße: 325x80 Hydraulik Servo  
mit automatischer Nachstellung  
(Kegelrollenlager)

Pos. 1



Pos. 2



Pos. 3



Pos. 4



Pos. 5



Pos. 6



Pos. 7



Pos. 9

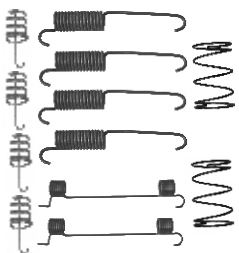

Pos. 10

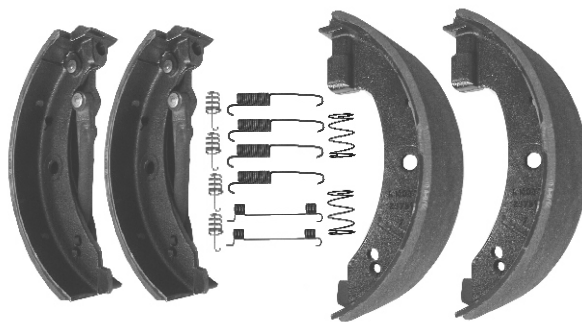

Pos. 11



Pos. 13



Pos. 12



Pos. 14



Pos. 15



Pos. 16



Pos. 17



Pos. 18



Pos. 19



Pos. 20



Pos. 21



Pos. 22



Das **Original**  
und Sie fahren mit Sicherheit weiter...

Pos	Bezeichnung	Bestell- nummer
1	Bremsnabe kpl. / moyeu de frein compl. / brake hub compl.	405111P002
2	Kappe / capouchon / cap	43651
3	Splint / boulon / spint-pin	D94.022
4	Kronenmutter / écrou crènelè / castle nut	D935.002
5	Kegelrollenlager / roulement à rouleaux coniques / taper roller bearing	45877.19
6	Kegelrollenlager / roulement à rouleaux coniques / taper roller bearing	45877.21
7	Anschlagscheibe / rondelle / washer	46279
9	Feder Set / traction set / spring set	406331.001
10	Bremsbacken Set / mâchoires de frein set / brake shoes set	406332.001
11	Radzylinder / cylindre de frein de roue / wheel brake cylindre <b>Ø 28,57 mm</b>	33179
12	Autom. Nachstellung kpl.	36160.01
13	Niederhalterung	44216
14	Sicherungsscheibe / blocage de rondelle / lock washer	44952.14
15	Sechskantschraube kpl./ vis a'six pans compl./ hex. bolt compl.	D933.042
16	Seilzug-Adapter / câble adapter / bowden cable adapter <b>Nirosta gekröpft 30°</b>	980149.01
17	Seilzug / câble / bowden cable <b>(1555/1712) Nirosta</b>	980161.01
	Seilzug / câble / bowden cable <b>(1723/1844) Nirosta</b>	980161.02
	Seilzug / câble / bowden cable <b>(2238/2408) Nirosta</b>	980161.03
18	Verschlussdeckel / couvercle / cover	44559.11
19	Verschlussdeckel / couvercle / cover	44559.03
20	Vierkantdeckel / couvercle / cover	44564.01
21	Flachbundmutter / écrou a bridge / flanged nut	D74361.005
22	Federring verz. / rondelle elastique galv. / spring ring zinc-plated	D74361.006

# BREMSTYP: 32,5-4301 / ABS

Bremsgröße: 325x80 Hydraulik Servo  
mit automatischer Nachstellung  
(Kegelrollenlager)

Pos. 1



Pos. 2



Pos. 3



Pos. 4



Pos. 5



Pos. 6



Pos. 7



Pos. 8



Pos. 9

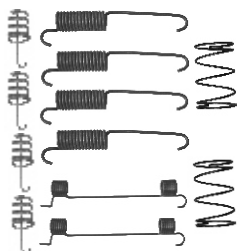

Pos. 10

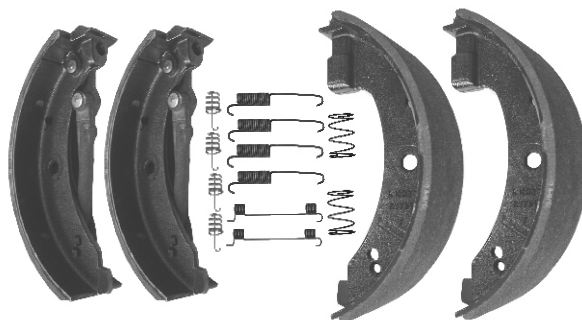

Pos. 11



Pos. 13



Pos. 12



Pos. 14



Pos. 15



Pos. 16



Pos. 17



Pos. 18



Pos. 19



Pos. 20



Pos. 21



Pos. 22





Das **Original**  
und Sie fahren mit Sicherheit weiter...

Pos	Bezeichnung	Bestell- nummer
1	Bremsnabe kpl. / moyeu de frein compl. / brake hub compl.	404092P002
2	Kappe / capouchon / cap	43651
3	Splint / boulon / spint-pin	D94.022
4	Kronenmutter / écrou crènelè / castle nut	D935.002
5	Kegelrollenlager / roulement à rouleaux coniques / taper roller bearing	45877.19
6	Kegelrollenlager / roulement à rouleaux coniques / taper roller bearing	45877.21
7	Anschlagscheibe / rondelle / washer	46279
8	ABS-Sensor Set <b>gerade</b>	404658.001
9	Feder Set / traction set / spring set	406331.001
10	Bremsbacken Set / mâchoires de frein set / brake shoes set	406332.001
11	Radzylinder / cylindre de frein de roue / wheel brake cylindre <b>Ø 28,57 mm</b>	33179
12	Autom. Nachstellung kpl.	36160.01
13	Niederhalterung	44216
14	Sicherungsscheibe / blocage de rondelle / lock washer	44952.14
15	Sechskantschraube kpl./ vis a'six pans compl./ hex. bolt compl.	D933.042
16	Seilzug-Adapter / câble adapter / bowden cable adapter <b>Nirosta gekröpft 30°</b>	980149.01
17	Seilzug / câble / bowden cable <b>(1555/1712) Nirosta</b>	980161.01
	Seilzug / câble / bowden cable <b>(1723/1844) Nirosta</b>	980161.02
	Seilzug / câble / bowden cable <b>(2238/2408) Nirosta</b>	980161.03
18	Verschlußdeckel / couvercle / cover	44559.11
19	Verschlußdeckel / couvercle / cover	44559.03
20	Vierkantdeckel / couvercle / cover	44564.01
21	Flachbundmutter / écrou a bridge / flanged nut	D74361.005
22	Federring verz. / rondelle elastique galv. / spring ring zinc-plated	D74361.006

# AUFLAUFEINRICHTUNG KF 7,5-C

Ausführung "KH"

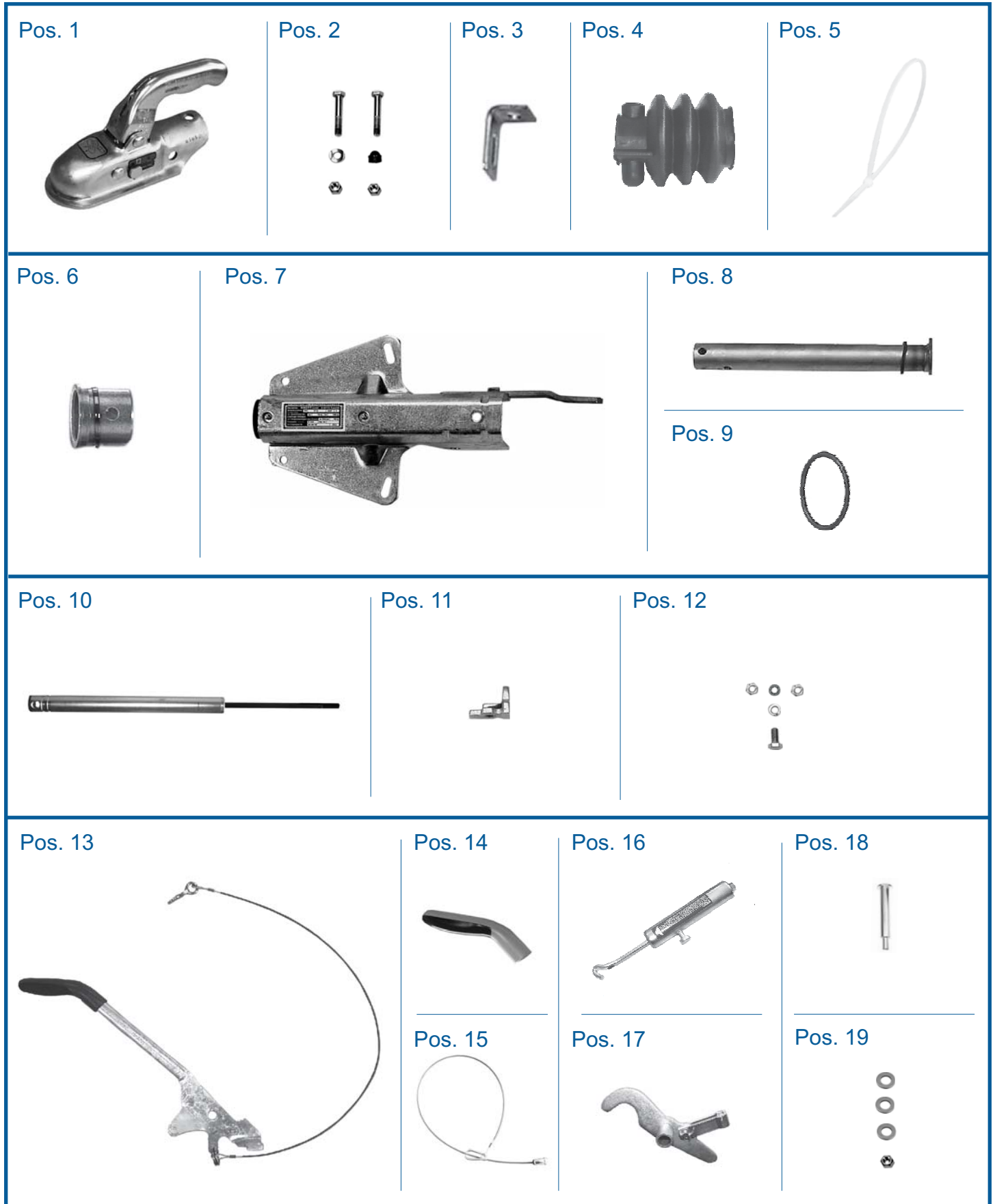

Das **Original**  
und Sie fahren mit Sicherheit weiter...

Pos	Bezeichnung	Bestell- nummer
1	Kugekupplung / attache a bille / ball-shaped coupling	8802429X
2	2x Sechskantschraube kpl./ vis a'six pans compl./ hex. bolt compl.	D931.017
	1x Sattelscheibe 13 verz./ disque a patin 13 galv./ caliper 13 zinc-plated	43004294
	2x Sicherungsmutter/ écrou de blocage/ lock nut	D980.004
	1x Sechskantschutzkappe / capuchonde protction Hexagonal / hex. Protective cap	45832.10
3	Halter f. Abreißeil/ support pour câble de d` attelage/ support f. breakaway cable	34006894
4	Faltenbalg/ accordeon/ bellows	69004692
5	Kabelband / câble-ruban / ribbon cable	71000194
6	Führungslager incl. Sicherungsstift / palier-guide / guide bearing	69005094
7	Gehäuse verz. / boiter compl. / housing zinc-plated	nur auf Anfrage
8	Zugstange kpl. / tirant compl./ drawbar compl. Incl. Pos. 9	98103094
9	Anschlagring / bague de butee / stop ring	69001494
10	Stoßdämpfer/ amortisseur de chocs pur/ shock absorber	87000313
11	Stoßdämpferhalter verz. / support d` amortisseure de chocs / shock absorber	21003494
12	1x Sechskantschraube kpl./ vis a'six pans compl./ hex. bolt compl.	D933.068
	1x Federring verz./ rondelle elastique/ spring ring	D127.008
	2x Sechskantmutter/ écrou a'six pans/ hex. nut	D934.011
	1x Federring verz./ rondelle elastique/ spring ring	D127.007
13	Handbremshebel kpl./ levier de frein a main compl./ handbrake lever compl.	98703193
14	Handgriff / la poignee / handle	200027.001
15	Abreißeil komplett/ câble de rupture d'attelage compl./ breakaway cable compl.	203202.002
16	Federhülse kpl. / douille a ressort compl. / spring sleeve compl.	98702594
17	Übersetzungshebel kpl./ levier de transmission compl./ transmisson lever compl.	98722483
18	Bolzen mit Gewindezapfen/ boulon avec goupille filet/ bolt with threaded pin	41004494
19	2x Scheibe A19 DIN125 PA / rondelle / washer	45908.18
	1x Scheibe A13 / rondelle / washer	D125.013
	1x Sicherungsmutter/ écrou de blocage/ lock nut	D980.004

# AUFLAUFEINRICHTUNG KF 9

Ausführung "HF"

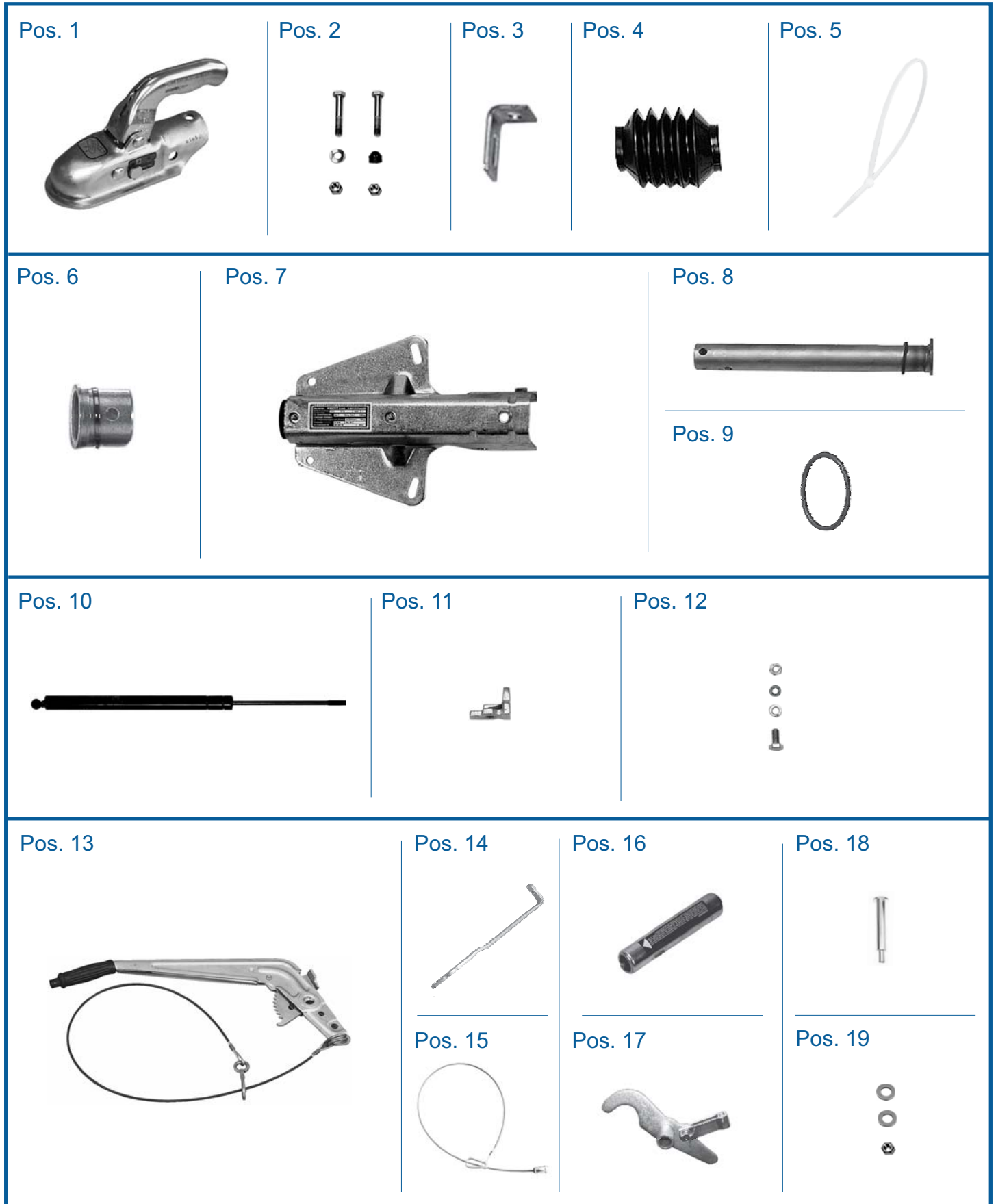

Das **Original**  
und Sie fahren mit Sicherheit weiter...

Pos	Bezeichnung	Bestell- nummer
1	Kugekupplung / attache a bille / ball-shaped coupling	8802469X
2	2x Sechskantschraube kpl./ vis a'six pans compl./ hex. bolt compl.	D931.016
	1x Sattelscheibe 13 verz./ disque a patin 13 galv./ caliper 13 zinc-plated	43004294
	2x Sicherungsmutter/ écrou de blocage/ lock nut	D980.004
	1x Sechskantschutzkappe / capuchonde protction Hexagonal / hex. Protective cap	45832.10
3	Halter f. Abreißeil/ support pour câble de d` attelage/ support f. breakaway cable	34006894
4	Faltenbalg/ accordeon/ bellows	69005693
5	Kabelband / câble-ruban / ribbon cable	71000194
6	Führungslager incl. Sicherungsstift / palier-guide / guide bearing	69005494
7	Gehäuse verz. / boiter compl. / housing zinc-plated	nur auf Anfrage
8	Zugstange kpl. / tirant compl./ drawbar compl. Incl. Pos. 9	200359.001
9	Anschlagring / bague de butee / stop ring	69005594
10	Stoßdämpfer/ amortisseur de chocs pur/ shock absorber	87004063
11	Stoßdämpferhalter verz. / support d` amortisseure de chocs / shock absorber	43008294
12	1x Sechskantschraube kpl./ vis a'six pans compl./ hex. bolt compl.	D931.008
	1x Federring verz./ rondelle elastique/ spring ring	D127.008
	1x Sechskantmutter/ écrou a'six pans/ hex. nut	D934.011
	1x Federring verz./ rondelle elastique/ spring ring	D127.007
13	Handbremshebel kpl./ levier de frein a main compl./ handbrake lever compl.	98532293
14	Druckfederhalter / support de ressort a pression / pressure spring fixing	34021093
15	Abreißeil komplett/ câble de rupture d'attelage compl./ breakaway cable compl.	203202.002
16	Federhülse kpl. / douille a ressort compl. / spring sleeve compl.	201233.001
17	Übersetzungshebel kpl./ levier de transmission compl./ transmisson lever compl.	200361.001
18	Bolzen mit Gewindezapfen/ boulon avec goupille filet/ bolt with threaded pin	41004494
19	1x Scheibe A19 DIN125 PA / rondelle / washer	45908.18
	1x Scheibe A13 / rondelle / washer	D125.012
	1x Scheibe A13 / rondelle / washer	D125.013
	1x Sicherungsmutter/ écrou de blocage/ lock nut	D980.004

# AUFLAUFEINRICHTUNG KF 13-C

Ausführung "HF"

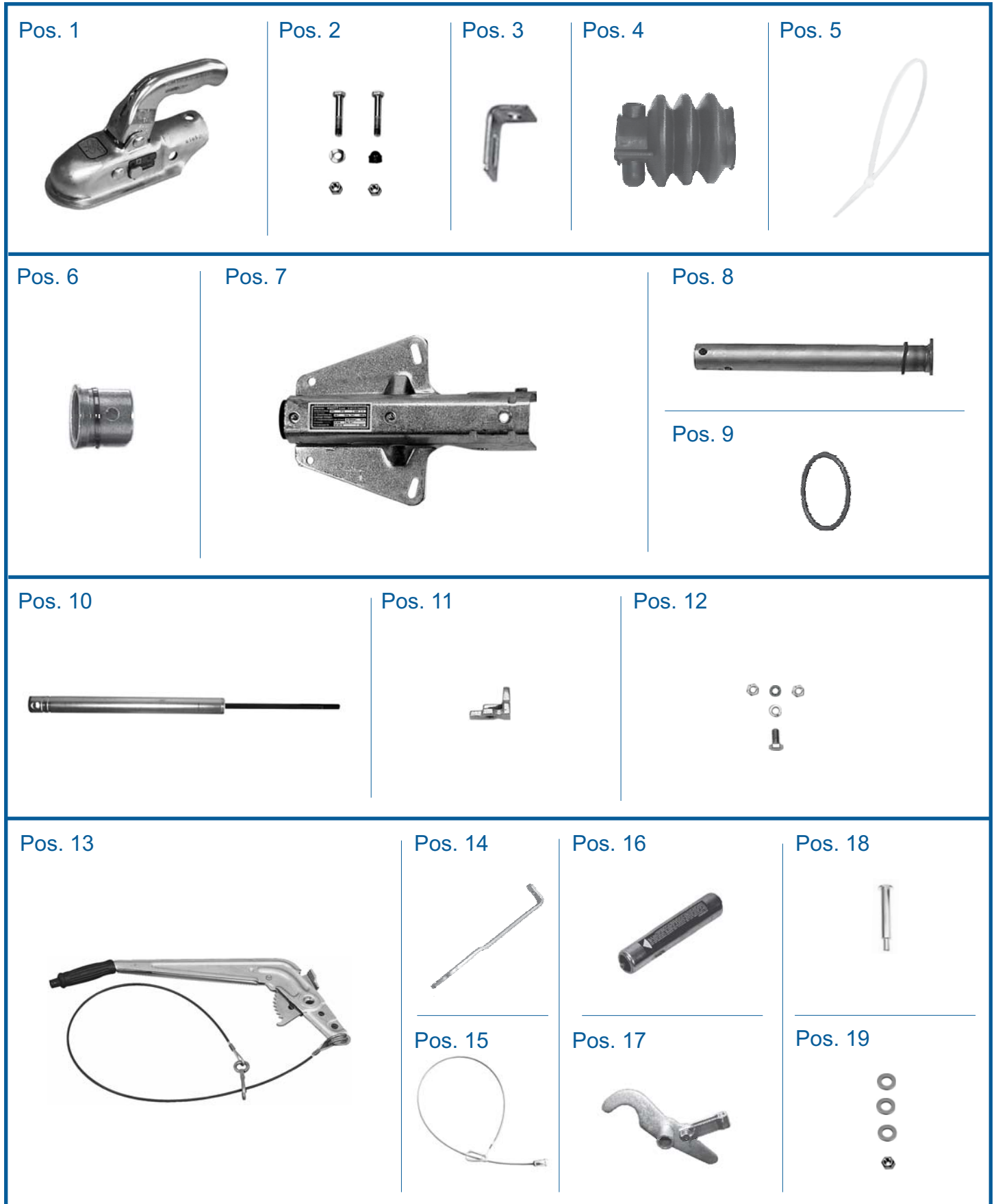

Das **Original**  
und Sie fahren mit Sicherheit weiter...

Pos	Bezeichnung	Bestell- nummer
1	Kugekupplung / attache a bille / ball-shaped coupling	8802429X
2	2x Sechskantschraube kpl./ vis a'six pans compl./ hex. bolt compl.	D931.017
	1x Sattelscheibe 13 verz./ disque a patin 13 galv./ caliper 13 zinc-plated	43004294
	2x Sicherungsmutter/ écrou de blocage/ lock nut	D980.004
	1x Sechskantschutzkappe / capuchonde protction Hexagonal / hex. Protective cap	45832.10
3	Halter f. Abreißeil/ support pour câble de d` attelage/ support f. breakaway cable	34006894
4	Faltenbalg/ accordeon/ bellows	69004692
5	Kabelband / câble-ruban / ribbon cable	71000194
6	Führungslager incl. Sicherungsstift / palier-guide / guide bearing	69005094
7	Gehäuse verz. / boiter compl. / housing zinc-plated	nur auf Anfrage
8	Zugstange kpl. / tirant compl./ drawbar compl. Incl. Pos. 9	98103094
9	Anschlagring / bague de butee / stop ring	69001494
10	Stoßdämpfer/ amortisseur de chocs pur/ shock absorber	87000713
11	Stoßdämpferhalter verz. / support d` amortisseure de chocs / shock absorber	21003494
12	1x Sechskantschraube kpl./ vis a'six pans compl./ hex. bolt compl.	D933.068
	1x Federring verz./ rondelle elastique/ spring ring	D127.008
	2x Sechskantmutter/ écrou a'six pans/ hex. nut	D934.011
	1x Federring verz./ rondelle elastique/ spring ring	D127.007
13	Handbremshebel kpl./ levier de frein a main compl./ handbrake lever compl.	98532293
14	Druckfederhalter / support de ressort a pression / pressure spring fixing	34021093
15	Abreißeil komplett/ câble de rupture d'attelage compl./ breakaway cable compl.	203202.002
16	Federhülse kpl. / douille a ressort compl. / spring sleeve compl.	98103393
17	Übersetzungshebel kpl./ levier de transmission compl./ transmisson lever compl.	9854419302
18	Bolzen mit Gewindezapfen/ boulon avec goupille filet/ bolt with threaded pin	41004494
19	2x Scheibe A19 DIN125 PA / rondelle / washer	45908.18
	1x Scheibe A13 / rondelle / washer	D125.013
	1x Sicherungsmutter/ écrou de blocage/ lock nut	D980.004

# AUFLAUFEINRICHTUNG KF 13-C

Ausführung "KH"

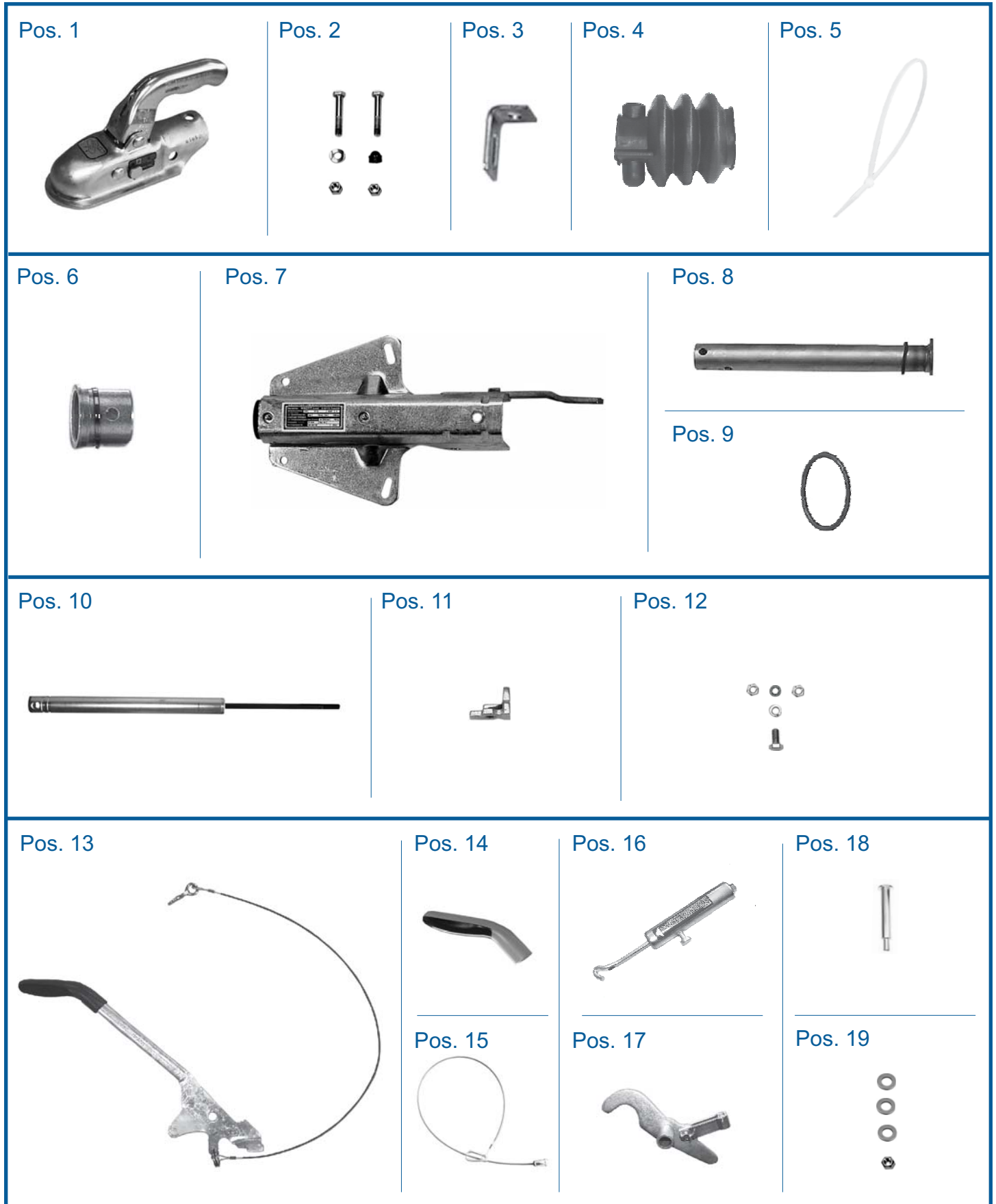



Das **Original**  
und Sie fahren mit Sicherheit weiter...

Pos	Bezeichnung	Bestell- nummer
1	Kugekupplung / attache a bille / ball-shaped coupling	8802429X
2	2x Sechskantschraube kpl./ vis a'six pans compl./ hex. bolt compl.	D931.017
	1x Sattelscheibe 13 verz./ disque a patin 13 galv./ caliper 13 zinc-plated	43004294
	2x Sicherungsmutter/ écrou de blocage/ lock nut	D980.004
	1x Sechskantschutzkappe / capuchonde protction Hexagonal / hex. Protective cap	45832.10
3	Halter f. Abreißeil/ support pour câble de d` attelage/ support f. breakaway cable	34006894
4	Faltenbalg/ accordeon/ bellows	69004692
5	Kabelband / câble-ruban / ribbon cable	71000194
6	Führungslager incl. Sicherungsstift / palier-guide / guide bearing	69005094
7	Gehäuse verz. / boiter compl. / housing zinc-plated	nur auf Anfrage
8	Zugstange kpl. / tirant compl./ drawbar compl. Incl. Pos. 9	98103094
9	Anschlagring / bague de butee / stop ring	69001494
10	Stoßdämpfer/ amortisseur de chocs pur/ shock absorber	87000713
11	Stoßdämpferhalter verz. / support d` amortisseure de chocs / shock absorber	21003494
12	1x Sechskantschraube kpl./ vis a'six pans compl./ hex. bolt compl.	D933.068
	1x Federring verz./ rondelle elastique/ spring ring	D127.008
	2x Sechskantmutter/ écrou a'six pans/ hex. nut	D934.011
	1x Federring verz./ rondelle elastique/ spring ring	D127.007
13	Handbremshebel kpl./ levier de frein a main compl./ handbrake lever compl.	98703193
14	Handgriff / la poignee / handle	200027.001
15	Abreißeil komplett/ câble de rupture d'attelage compl./ breakaway cable compl.	203202.002
16	Federhülse kpl. / douille a ressort compl. / spring sleeve compl.	98702594
17	Übersetzungshebel kpl./ levier de transmission compl./ transmisson lever compl.	98722483
18	Bolzen mit Gewindezapfen/ boulon avec goupille filet/ bolt with threaded pin	41004494
19	2x Scheibe A19 DIN125 PA / rondelle / washer	45908.18
	1x Scheibe A13 / rondelle / washer	D125.013
	1x Sicherungsmutter/ écrou de blocage/ lock nut	D980.004

# AUFLAUFEINRICHTUNG KF 13-C

Ausführung "GF"

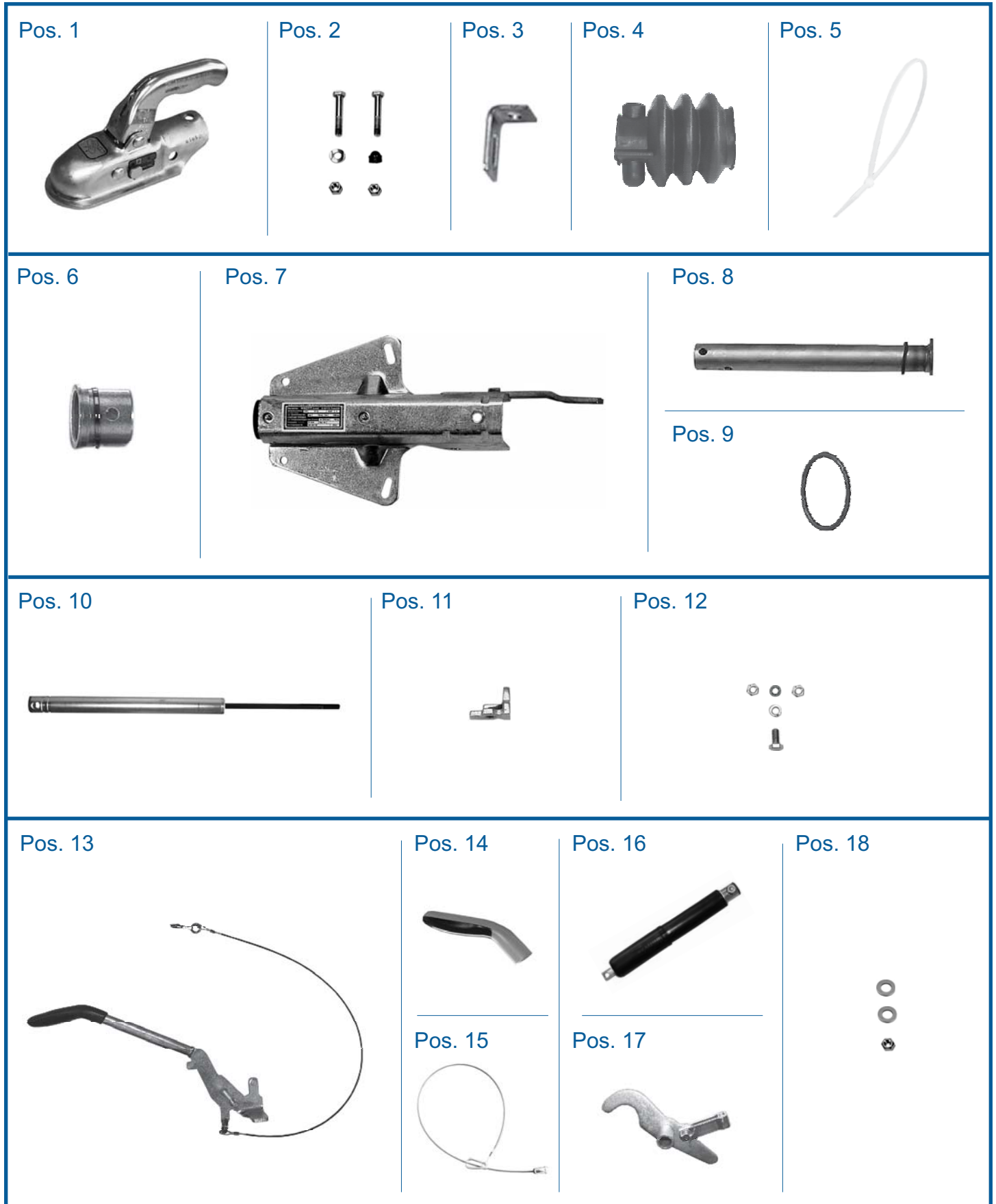

Das **Original**  
und Sie fahren mit Sicherheit weiter...

Pos	Bezeichnung	Bestell- nummer
1	Kugekupplung / attache a bille / ball-shaped coupling	8802429X
2	2x Sechskantschraube kpl./ vis a'six pans compl./ hex. bolt compl.	D931.017
	1x Sattelscheibe 13 verz./ disque a patin 13 galv./ caliper 13 zinc-plated	43004294
	2x Sicherungsmutter/ écrou de blocage/ lock nut	D980.004
	1x Sechskantschutzkappe / capuchonde protction Hexagonal / hex. Protective cap	45832.10
3	Halter f. Abreißeil/ support pour câble de d` attelage/ support f. breakaway cable	34006894
4	Faltenbalg/ accordeon/ bellows	69004692
5	Kabelband / câble-ruban / ribbon cable	71000194
6	Führungslager incl. Sicherungsstift / palier-guide / guide bearing	69005094
7	Gehäuse verz. / boiter compl. / housing zinc-plated	nur auf Anfrage
8	Zugstange kpl. / tirant compl./ drawbar compl. Incl. Pos. 9	98103094
9	Anschlagring / bague de butee / stop ring	69001494
10	Stoßdämpfer/ amortisseur de chocs pur/ shock absorber	87000713
11	Stoßdämpferhalter verz. / support d` amortisseure de chocs / shock absorber	21003494
12	1x Sechskantschraube kpl./ vis a'six pans compl./ hex. bolt compl.	D933.068
	1x Federring verz./ rondelle elastique/ spring ring	D127.008
	2x Sechskantmutter/ écrou a'six pans/ hex. nut	D934.011
	1x Federring verz./ rondelle elastique/ spring ring	D127.007
13	Handbremshebel kpl./ levier de frein a main compl./ handbrake lever compl.	201943.001
14	Handgriff / la poignee / handle	200027.001
15	Abreißeil komplett/ câble de rupture d'attelage compl./ breakaway cable compl.	203202.002
16	Federspeicher "GF" kpl. / douille a ressort compl. / spring sleeve compl.	201856.001
17	Übersetzungshebel kpl./ levier de transmission compl./ transmisson lever compl.	98722483
18	1x Scheibe A19 DIN125 PA / rondelle / washer	45908.18
	1x Scheibe A13 / rondelle / washer	D125.013
	1x Sicherungsmutter/ écrou de blocage/ lock nut	D980.004

# AUFLAUFEINRICHTUNG KF 17-C

Ausführung "HF"

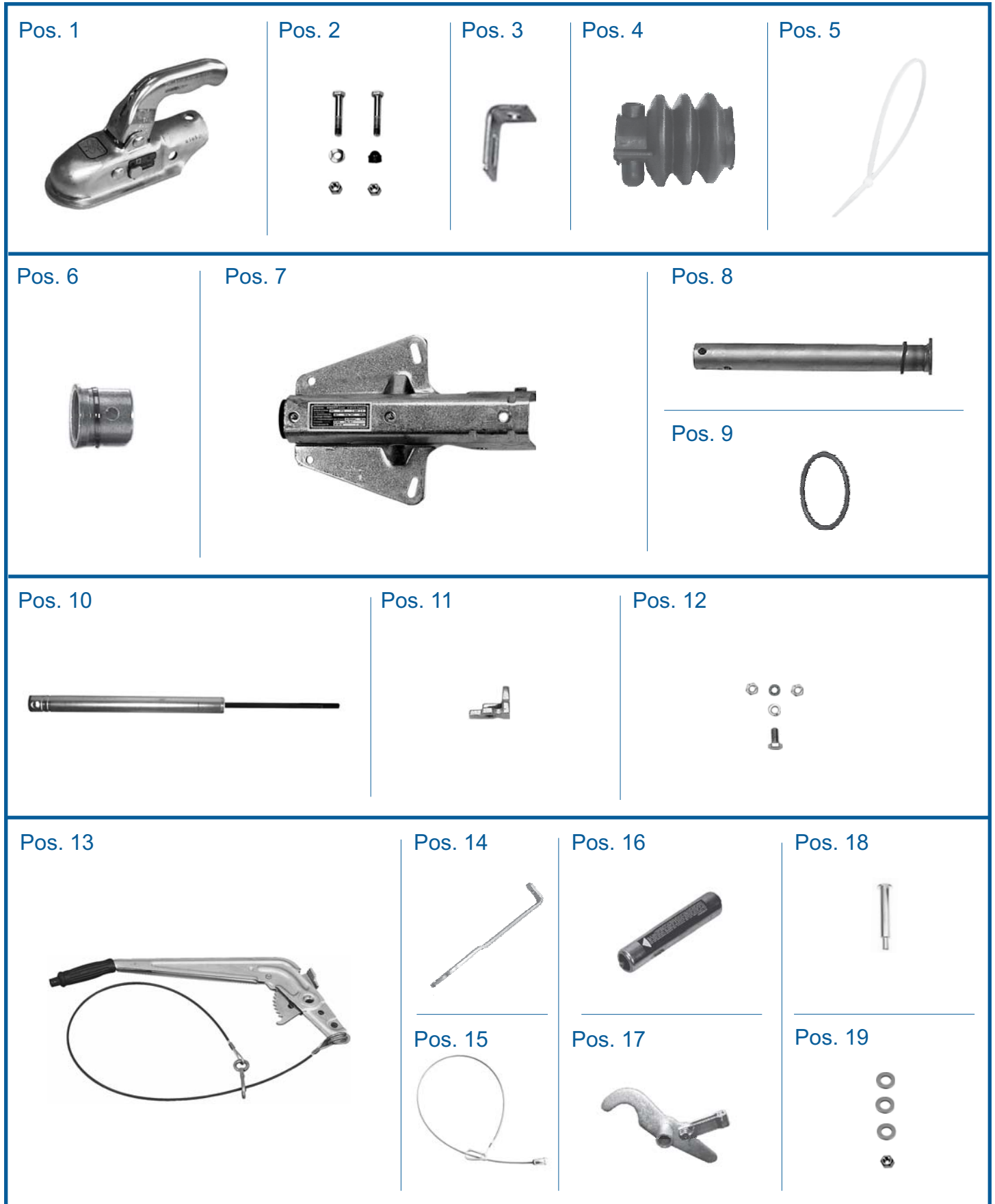

Das **Original**  
und Sie fahren mit Sicherheit weiter...

Pos	Bezeichnung	Bestell- nummer
1	Kugekupplung / attache a bille / ball-shaped coupling	8802399X
2	2x Sechskantschraube kpl./ vis a'six pans compl./ hex. bolt compl.	D931.017
	1x Sattelscheibe 13 verz./ disque a patin 13 galv./ caliper 13 zinc-plated	43004294
	2x Sicherungsmutter/ écrou de blocage/ lock nut	D980.004
	1x Sechskantschutzkappe / capuchonde protction Hexagonal / hex. Protective cap	45832.10
3	Halter f. Abreißeil/ support pour câble de d` attelage/ support f. breakaway cable	34006894
4	Faltenbalg/ accordeon/ bellows	69004692
5	Kabelband / câble-ruban / ribbon cable	71000194
6	Führungslager incl. Sicherungsstift / palier-guide / guide bearing	69005094
7	Gehäuse verz. / boiter compl. / housing zinc-plated	nur auf Anfrage
8	Zugstange kpl. / tirant compl./ drawbar compl. Incl. Pos. 9	98103094
9	Anschlagring / bague de butee / stop ring	69001494
10	Stoßdämpfer/ amortisseur de chocs pur/ shock absorber	87001113
11	Stoßdämpferhalter verz. / support d` amortisseure de chocs / shock absorber	21003494
12	1x Sechskantschraube kpl./ vis a'six pans compl./ hex. bolt compl.	D933.068
	1x Federring verz./ rondelle elastique/ spring ring	D127.008
	2x Sechskantmutter/ écrou a'six pans/ hex. nut	D934.011
	1x Federring verz./ rondelle elastique/ spring ring	D127.007
13	Handbremshebel kpl./ levier de frein a main compl./ handbrake lever compl.	98532293
14	Druckfederhalter / support de ressort a pression / pressure spring fixing	34021093
15	Abreißeil komplett/ câble de rupture d'attelage compl./ breakaway cable compl.	203202.002
16	Federhülse kpl. / douille a ressort compl. / spring sleeve compl.	98103393
17	Übersetzungshebel kpl./ levier de transmission compl./ transmisson lever compl.	9854419302
18	Bolzen mit Gewindezapfen/ boulon avec goupille filet/ bolt with threaded pin	41004494
19	2x Scheibe A19 DIN125 PA / rondelle / washer	45908.18
	1x Scheibe A13 / rondelle / washer	D125.013
	1x Sicherungsmutter/ écrou de blocage/ lock nut	D980.004

# AUFLAUFEINRICHTUNG KF 17-C

Ausführung "KH"

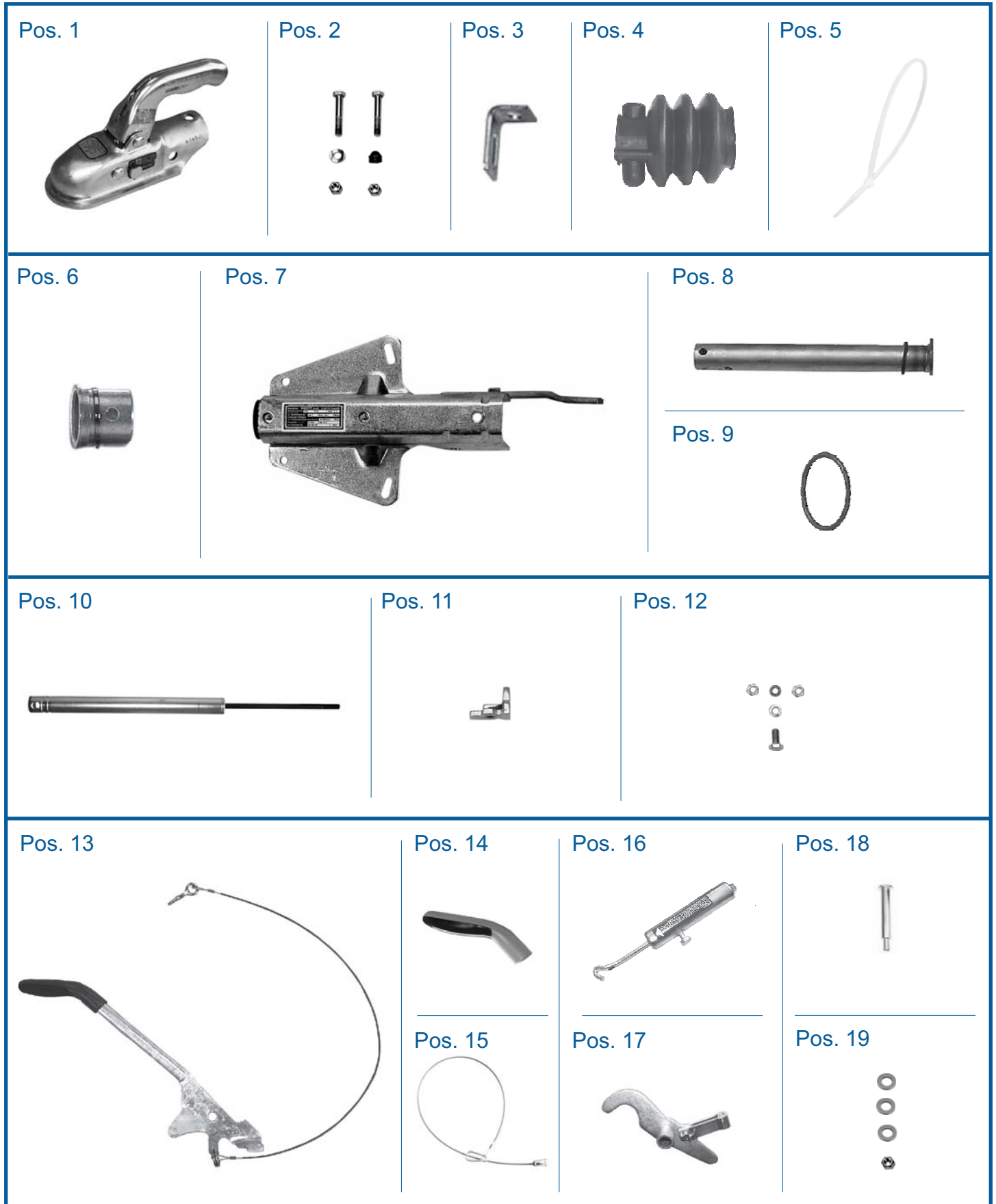

Das **Original**  
und Sie fahren mit Sicherheit weiter...

Pos	Bezeichnung	Bestell- nummer
1	Kugekupplung / attache a bille / ball-shaped coupling	8802399X
2	2x Sechskantschraube kpl./ vis a'six pans compl./ hex. bolt compl.	D931.017
	1x Sattelscheibe 13 verz./ disque a patin 13 galv./ caliper 13 zinc-plated	43004294
	2x Sicherungsmutter/ écrou de blocage/ lock nut	D980.004
	1x Sechskantschutzkappe / capuchonde protction Hexagonal / hex. Protective cap	45832.10
3	Halter f. Abreißeil/ support pour câble de d` attelage/ support f. breakaway cable	34006894
4	Faltenbalg/ accordeon/ bellows	69004692
5	Kabelband / câble-ruban / ribbon cable	71000194
6	Führungslager incl. Sicherungsstift / palier-guide / guide bearing	69005094
7	Gehäuse verz. / boiter compl. / housing zinc-plated	nur auf Anfrage
8	Zugstange kpl. / tirant compl./ drawbar compl. Incl. Pos. 9	98103094
9	Anschlagring / bague de butee / stop ring	69001494
10	Stoßdämpfer/ amortisseur de chocs pur/ shock absorber	87001113
11	Stoßdämpferhalter verz. / support d` amortisseure de chocs / shock absorber	21003494
12	1x Sechskantschraube kpl./ vis a'six pans compl./ hex. bolt compl.	D933.068
	1x Federring verz./ rondelle elastique/ spring ring	D127.008
	2x Sechskantmutter/ écrou a'six pans/ hex. nut	D934.011
	1x Federring verz./ rondelle elastique/ spring ring	D127.007
13	Handbremshebel kpl./ levier de frein a main compl./ handbrake lever compl.	98703193
14	Handgriff / la poignee / handle	200027.001
15	Abreißeil komplett/ câble de rupture d'attelage compl./ breakaway cable compl.	203202.002
16	Federhülse kpl. / douille a ressort compl. / spring sleeve compl.	98702594
17	Übersetzungshebel kpl./ levier de transmission compl./ transmisson lever compl.	98722483
18	Bolzen mit Gewindezapfen/ boulon avec goupille filet/ bolt with threaded pin	41004494
19	2x Scheibe A19 DIN125 PA / rondelle / washer	45908.18
	1x Scheibe A13 / rondelle / washer	D125.013
	1x Sicherungsmutter/ écrou de blocage/ lock nut	D980.004

# AUFLAUFEINRICHTUNG KF 17-C

Ausführung "GF"

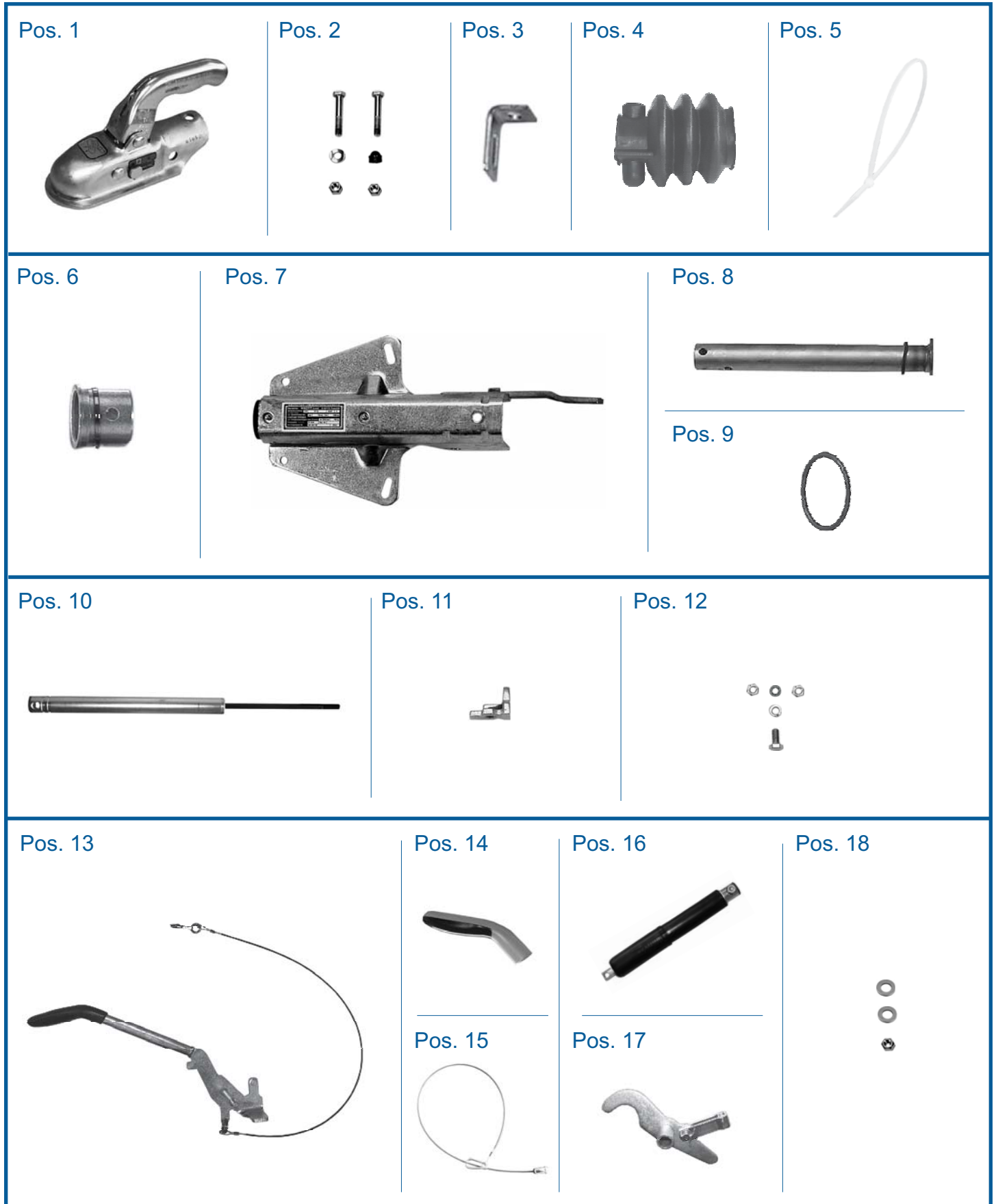



Das **Original**  
und Sie fahren mit Sicherheit weiter...

Pos	Bezeichnung	Bestell- nummer
1	Kugekupplung / attache a bille / ball-shaped coupling	8802399X
2	2x Sechskantschraube kpl./ vis a'six pans compl./ hex. bolt compl.	D931.017
	1x Sattelscheibe 13 verz./ disque a patin 13 galv./ caliper 13 zinc-plated	43004294
	2x Sicherungsmutter/ écrou de blocage/ lock nut	D980.004
	1x Sechskantschutzkappe / capuchonde protction Hexagonal / hex. Protective cap	45832.10
3	Halter f. Abreißeil/ support pour câble de d` attelage/ support f. breakaway cable	34006894
4	Faltenbalg/ accordeon/ bellows	69004692
5	Kabelband / câble-ruban / ribbon cable	71000194
6	Führungslager incl. Sicherungsstift / palier-guide / guide bearing	69005094
7	Gehäuse verz. / boiter compl. / housing zinc-plated	nur auf Anfrage
8	Zugstange kpl. / tirant compl./ drawbar compl. Incl. Pos. 9	98103094
9	Anschlagring / bague de butee / stop ring	69001494
10	Stoßdämpfer/ amortisseur de chocs pur/ shock absorber	87001113
11	Stoßdämpferhalter verz. / support d` amortisseure de chocs / shock absorber	21003494
12	1x Sechskantschraube kpl./ vis a'six pans compl./ hex. bolt compl.	D933.068
	1x Federring verz./ rondelle elastique/ spring ring	D127.008
	2x Sechskantmutter/ écrou a'six pans/ hex. nut	D934.011
	1x Federring verz./ rondelle elastique/ spring ring	D127.007
13	Handbremshebel kpl./ levier de frein a main compl./ handbrake lever compl.	201943.001
14	Handgriff / la poignee / handle	200027.001
15	Abreißeil komplett/ câble de rupture d'attelage compl./ breakaway cable compl.	203202.002
16	Federspeicher "GF" kpl. / douille a ressort compl. / spring sleeve compl.	201856.001
17	Übersetzungshebel kpl./ levier de transmission compl./ transmisson lever compl.	98722483
18	1x Scheibe A19 DIN125 PA / rondelle / washer	45908.18
	1x Scheibe A13 / rondelle / washer	D125.013
	1x Sicherungsmutter/ écrou de blocage/ lock nut	D980.004

# AUFLAUFEINRICHTUNG KF 20-A

Ausführung "HF"

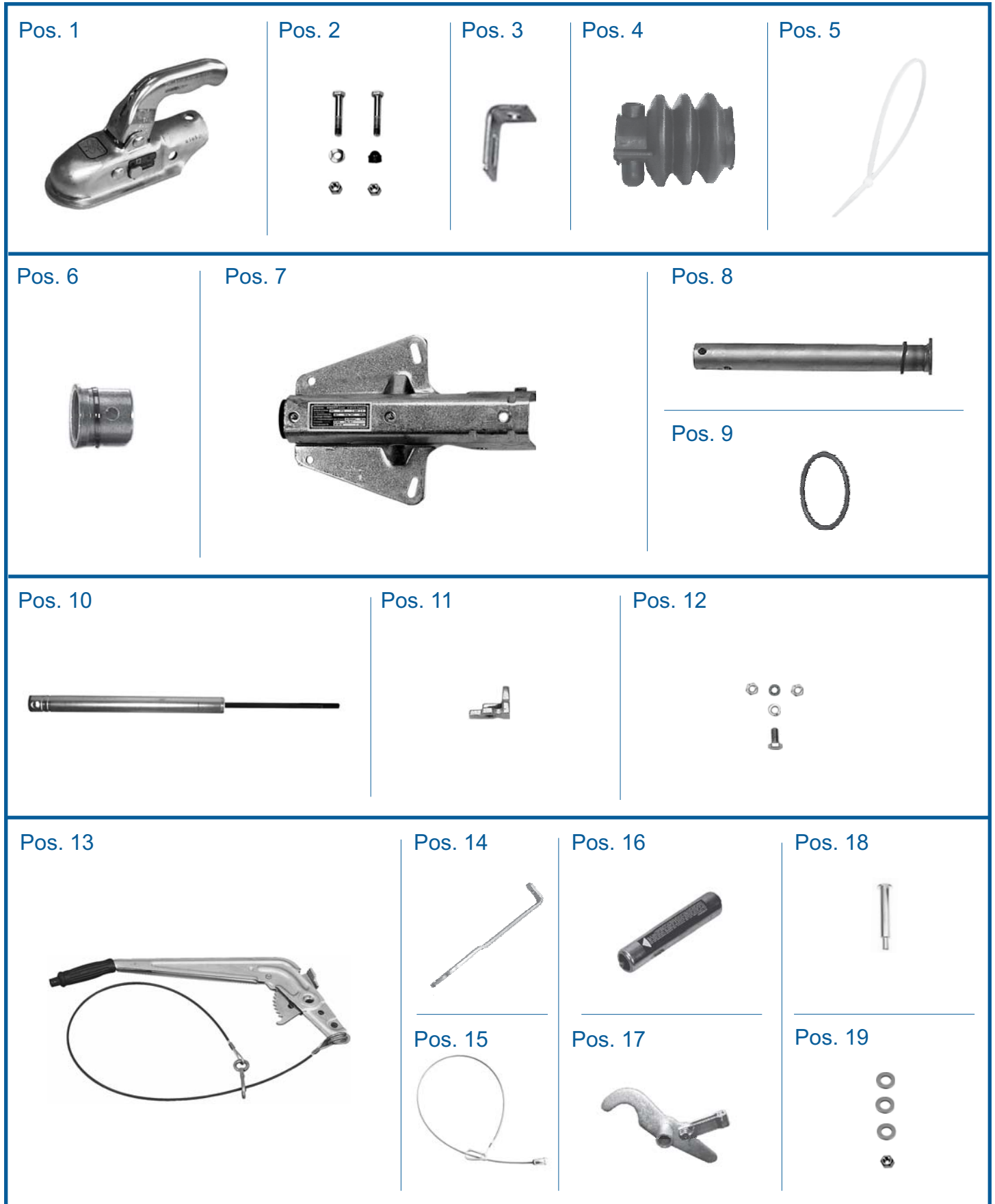

Das **Original**  
und Sie fahren mit Sicherheit weiter...

Pos	Bezeichnung	Bestell- nummer
1	Kugekupplung / attache a bille / ball-shaped coupling	8802399X
2	2x Sechskantschraube kpl./ vis a'six pans compl./ hex. bolt compl.	D931.017
	1x Sattelscheibe 13 verz./ disque a patin 13 galv./ caliper 13 zinc-plated	43004294
	2x Sicherungsmutter/ écrou de blocage/ lock nut	D980.004
	1x Sechskantschutzkappe / capuchonde protction Hexagonal / hex. Protective cap	45832.10
3	Halter f. Abreißeil/ support pour câble de d` attelage/ support f. breakaway cable	34006894
4	Faltenbalg/ accordeon/ bellows	69004692
5	Kabelband / câble-ruban / ribbon cable	71000194
6	Führungslager incl. Sicherungsstift / palier-guide / guide bearing	69005094
7	Gehäuse verz. / boiter compl. / housing zinc-plated	nur auf Anfrage
8	Zugstange kpl. / tirant compl./ drawbar compl. Incl. Pos. 9	98103094
9	Anschlagring / bague de butee / stop ring	69001494
10	Stoßdämpfer/ amortisseur de chocs pur/ shock absorber	87001113
11	Stoßdämpferhalter verz. / support d` amortisseure de chocs / shock absorber	21003494
12	1x Sechskantschraube kpl./ vis a'six pans compl./ hex. bolt compl.	D933.068
	1x Federring verz./ rondelle elastique/ spring ring	D127.008
	2x Sechskantmutter/ écrou a'six pans/ hex. nut	D934.011
	1x Federring verz./ rondelle elastique/ spring ring	D127.007
13	Handbremshebel kpl./ levier de frein a main compl./ handbrake lever compl.	98532293
14	Druckfederhalter / support de ressort a pression / pressure spring fixing	34021093
15	Abreißeil komplett/ câble de rupture d'attelage compl./ breakaway cable compl.	203202.002
16	Federhülse kpl. / douille a ressort compl. / spring sleeve compl.	98103393
17	Übersetzungshebel kpl./ levier de transmission compl./ transmisson lever compl.	9854419302
18	Bolzen mit Gewindezapfen/ boulon avec goupille filet/ bolt with threaded pin	41004494
19	2x Scheibe A19 DIN125 PA / rondelle / washer	45908.18
	1x Scheibe A13 / rondelle / washer	D125.013
	1x Sicherungsmutter/ écrou de blocage/ lock nut	D980.004

# AUFLAUFEINRICHTUNG KF 20-A

Ausführung "KH"

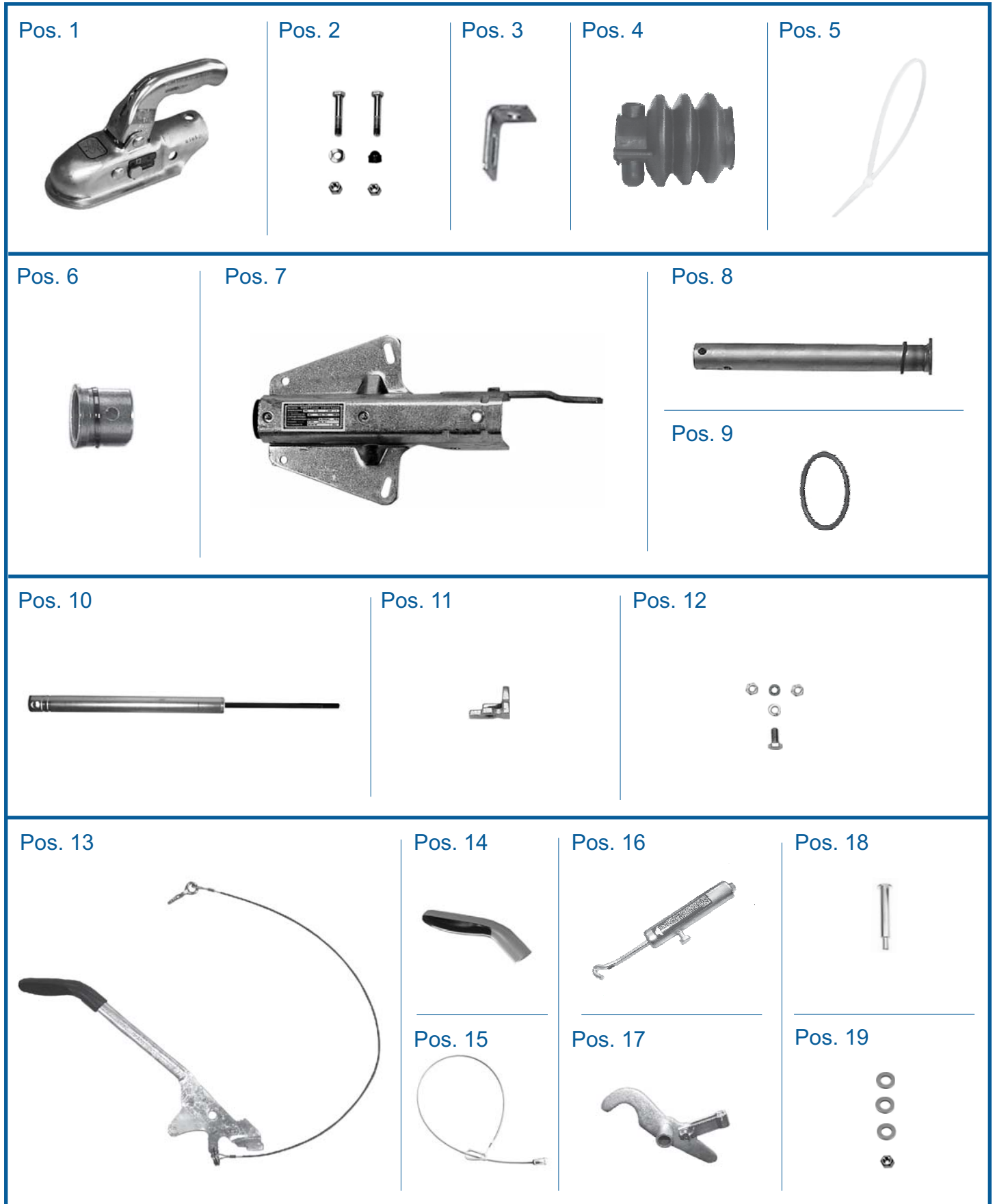

Das **Original**  
und Sie fahren mit Sicherheit weiter...

Pos	Bezeichnung	Bestell- nummer
1	Kugekupplung / attache a bille / ball-shaped coupling	8802399X
2	2x Sechskantschraube kpl./ vis a'six pans compl./ hex. bolt compl.	D931.017
	1x Sattelscheibe 13 verz./ disque a patin 13 galv./ caliper 13 zinc-plated	43004294
	2x Sicherungsmutter/ écrou de blocage/ lock nut	D980.004
	1x Sechskantschutzkappe / capuchonde protction Hexagonal / hex. Protective cap	45832.10
3	Halter f. Abreißeil/ support pour câble de d` attelage/ support f. breakaway cable	34006894
4	Faltenbalg/ accordeon/ bellows	69004692
5	Kabelband / câble-ruban / ribbon cable	71000194
6	Führungslager incl. Sicherungsstift / palier-guide / guide bearing	69005094
7	Gehäuse verz. / boiter compl. / housing zinc-plated	nur auf Anfrage
8	Zugstange kpl. / tirant compl./ drawbar compl. Incl. Pos. 9	98103094
9	Anschlagring / bague de butee / stop ring	69001494
10	Stoßdämpfer/ amortisseur de chocs pur/ shock absorber	87001113
11	Stoßdämpferhalter verz. / support d` amortisseure de chocs / shock absorber	21003494
12	1x Sechskantschraube kpl./ vis a'six pans compl./ hex. bolt compl.	D933.068
	1x Federring verz./ rondelle elastique/ spring ring	D127.008
	2x Sechskantmutter/ écrou a'six pans/ hex. nut	D934.011
	1x Federring verz./ rondelle elastique/ spring ring	D127.007
13	Handbremshebel kpl./ levier de frein a main compl./ handbrake lever compl.	98703193
14	Handgriff / la poignee / handle	200027.001
15	Abreißeil komplett/ câble de rupture d'attelage compl./ breakaway cable compl.	203202.002
16	Federhülse kpl. / douille a ressort compl. / spring sleeve compl.	98702594
17	Übersetzungshebel kpl./ levier de transmission compl./ transmisson lever compl.	98722483
18	Bolzen mit Gewindezapfen/ boulon avec goupille filet/ bolt with threaded pin	41004494
19	2x Scheibe A19 DIN125 PA / rondelle / washer	45908.18
	1x Scheibe A13 / rondelle / washer	D125.013
	1x Sicherungsmutter/ écrou de blocage/ lock nut	D980.004

# AUFLAUFEINRICHTUNG KF 20-A

Ausführung "GF"

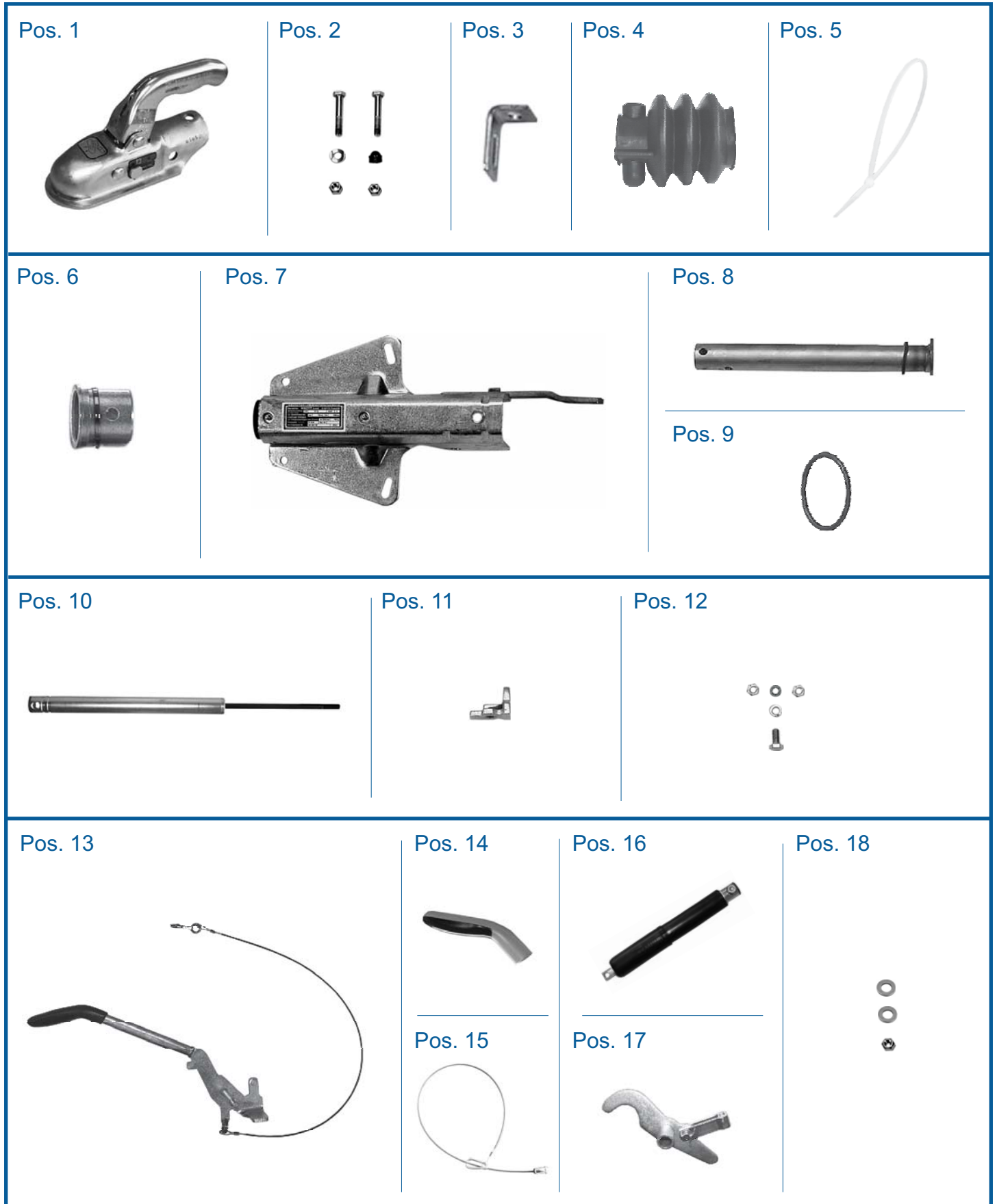

Das **Original**  
und Sie fahren mit Sicherheit weiter...

Pos	Bezeichnung	Bestell- nummer
1	Kugekupplung / attache a bille / ball-shaped coupling	8802399X
2	2x Sechskantschraube kpl./ vis a'six pans compl./ hex. bolt compl.	D931.017
	1x Sattelscheibe 13 verz./ disque a patin 13 galv./ caliper 13 zinc-plated	43004294
	2x Sicherungsmutter/ écrou de blocage/ lock nut	D980.004
	1x Sechskantschutzkappe / capuchonde protction Hexagonal / hex. Protective cap	45832.10
3	Halter f. Abreißeil/ support pour câble de d` attelage/ support f. breakaway cable	34006894
4	Faltenbalg/ accordeon/ bellows	69004692
5	Kabelband / câble-ruban / ribbon cable	71000194
6	Führungslager incl. Sicherungsstift / palier-guide / guide bearing	69005094
7	Gehäuse verz. / boiter compl. / housing zinc-plated	nur auf Anfrage
8	Zugstange kpl. / tirant compl./ drawbar compl. Incl. Pos. 9	98103094
9	Anschlagring / bague de butee / stop ring	69001494
10	Stoßdämpfer/ amortisseur de chocs pur/ shock absorber	87001113
11	Stoßdämpferhalter verz. / support d` amortisseure de chocs / shock absorber	21003494
12	1x Sechskantschraube kpl./ vis a'six pans compl./ hex. bolt compl.	D933.068
	1x Federring verz./ rondelle elastique/ spring ring	D127.008
	2x Sechskantmutter/ écrou a'six pans/ hex. nut	D934.011
	1x Federring verz./ rondelle elastique/ spring ring	D127.007
13	Handbremshebel kpl./ levier de frein a main compl./ handbrake lever compl.	201943.001
14	Handgriff / la poignee / handle	200027.001
15	Abreißeil komplett/ câble de rupture d'attelage compl./ breakaway cable compl.	203202.002
16	Federspeicher "GF" kpl. / douille a ressort compl. / spring sleeve compl.	201856.001
17	Übersetzungshebel kpl./ levier de transmission compl./ transmisson lever compl.	98722483
18	1x Scheibe A19 DIN125 PA / rondelle / washer	45908.18
	1x Scheibe A13 / rondelle / washer	D125.013
	1x Sicherungsmutter/ écrou de blocage/ lock nut	D980.004

# AUFLAUFEINRICHTUNG KF 20-A

Ausführung "HF" hydraulik

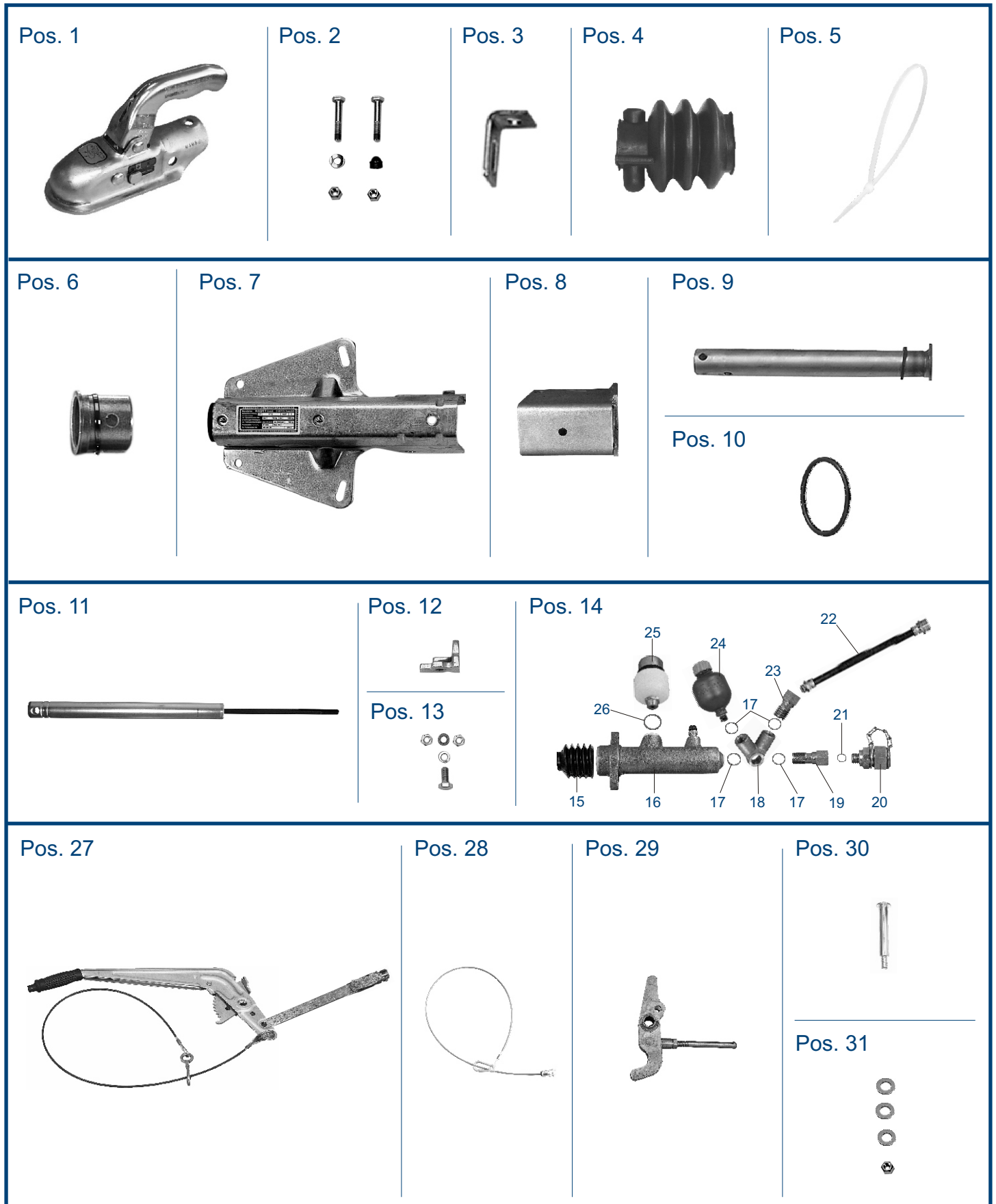



Das **Original**  
und Sie fahren mit Sicherheit weiter...

Pos	Bezeichnung	Bestellnummer
1	Kugelkupplung / attache a bille / ball-shaped coupling	8802399X
2	2x Sechskantschraube kpl./ vis a'six pans compl./ hex. bolt compl.	D931.017
	1x Sattelscheibe 13 verz./ disque a patin 13 galv./ caliper 13 zinc-plated	43004294
	2x Sicherungsmutter/ écrou de blocage/ lock nut	D980.004
	1x Sechskantschutzkappe / capuchonde protction Hexagonal / hex. Protective cap	45832.10
3	Halter f. Abreißeil/ support pour câble de d` attelage/ support f. breakaway cable	34006894
4	Faltenbalg/ accordeon/ bellows	69004692
5	Kabelband / câble-ruban / ribbon cable	71000194
6	Führungslager incl. Sicherungsstift / palier-guide / guide bearing	69005094
7	Gehäuse verz. / boiter compl. / housing zinc-plated	nur auf Anfrage
8	Konsole verz. / vitesse galv. / welded zinc-plated	98048993
9	Zugstange kpl. / tirant compl./ drawbar compl. Incl. Pos. 9	98103094
10	Anschlagring / bague de butee / stop ring	69001494
11	Stoßdämpfer/ amortisseur de chocs pur/ shock absorber	87001113
12	Stoßdämpferhalter verz. / support d` amortisseure de chocs / shock absorber	21003494
13	1x Sechskantschraube kpl./ vis a'six pans compl./ hex. bolt compl.	D933.068
	1x Federring verz./ rondelle elastique/ spring ring	D127.008
	2x Sechskantmutter/ écrou a'six pans/ hex. nut	D934.011
	1x Federring verz./ rondelle elastique/ spring ring	D127.007
14	Hydraulik Set kpl.	98593409
15	Faltenbalg/ accordeon/ bellows	46613
16	Hauptbremszylinder / cylindre de frein principal / main brake cylindre	101231.01
17	Kuperdichtring / anneau d` etanche en cuivre / copper gasket	44165
18	Ringstutzen / raccord annulaire / ring socket	36150
19	Hohlschraube / boulon creux a filet femelle / hollow screw	47011
20	Prüfanschluß / raccordement d`essai / test connection	47010
21	Kuperdichtring / anneau d` etanche en cuivre / copper gasket	47013
22	Bremsschlauch / flexible de frein / brake hose	37452.0350
23	Schraubstutzen / bouchon filet / screw socket	45780
24	Hydrospeicher / accumulateur de pression / pressure reservoir	46421.060
25	Ausgleichsbehälter / reservoir d` egalisation / expansion bracket	47348
26	Kuperdichtring / anneau d` etanche en cuivre / copper gasket	47012
27	Handbremshebel kpl./ levier de frein a main compl./ handbrake lever compl.	98866493
28	Abreißeil komplett/ câble de rupture d'attelage compl./ breakaway cable compl.	203202.002
29	Übersetzungshebel kpl./ levier de transmission compl./ transmisson lever compl.	98594193
30	Bolzen mit Gewindezapfen/ boulon avec goupille filet/ bolt with threaded pin	41004494
31	2x Scheibe A19 DIN125 PA / rondelle / washer	45908.18
	1x Scheibe A13 / rondelle / washer	D125.013
	1x Sicherungsmutter/ écrou de blocage/ lock nut	D980.004

# AUFLAUFEINRICHTUNG KF 27-A

Ausführung "KH"

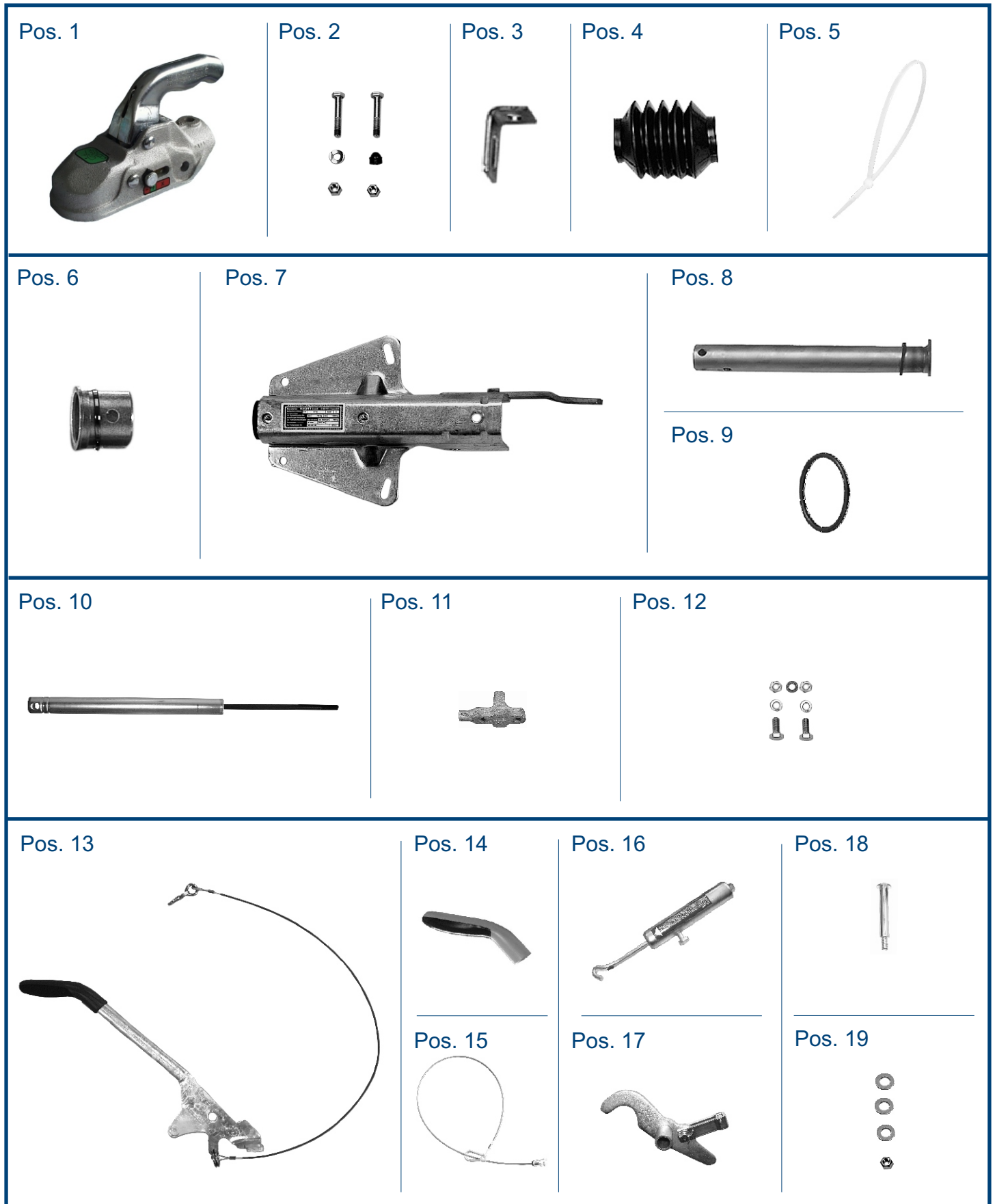

Das **Original**  
und Sie fahren mit Sicherheit weiter...

Pos	Bezeichnung	Bestell- nummer
1	Kugelkupplung / attache a bille / ball-shaped coupling	8802409X
2	2x Sechskantschraube kpl./ vis a'six pans compl./ hex. bolt compl.	D931.022
	1x Sattelscheibe 13 verz./ disque a patin 13 galv./ caliper 13 zinc-plated	43004294
	2x Sicherungsmutter/ écrou de blocage/ lock nut	D980.004
	1x Sechskantschutzkappe / capuchonde protction Hexagonal / hex. Protective cap	45832.10
3	Halter f. Abreißeil/ support pour câble de d` attelage/ support f. breakaway cable	34006894
4	Faltenbalg/ accordeon/ bellows	69000393
5	Kabelband / câble-ruban / ribbon cable	71000194
6	Führungslager incl. Sicherungsstift / palier-guide / guide bearing	69005194
7	Gehäuse verz. / boiter compl. / housing zinc-plated	nur auf Anfrage
8	Zugstange kpl. / tirant compl./ drawbar compl. Incl. Pos. 9	98103894
9	Anschlagring / bague de butee / stop ring	69001494
10	Stoßdämpfer/ amortisseur de chocs pur/ shock absorber	87003913
11	Stoßdämpferhalter verz. / support d` amortisseure de chocs / shock absorber	21003593
12	2x Sechskantschraube kpl./ vis a'six pans compl./ hex. bolt compl.	D933.068
	2x Federring verz./ rondelle elastique/ spring ring	D127.008
	2x Sechskantmutter/ écrou a'six pans/ hex. nut	D934.011
	1x Federring verz./ rondelle elastique/ spring ring	D127.007
13	Handbremshebel kpl./ levier de frein a main compl./ handbrake lever compl.	98703193
14	Handgriff / la poignee / handle	200027.001
15	Abreißeil komplett/ câble de rupture d'attelage compl./ breakaway cable compl.	203202.002
16	Federhülse kpl. / douille a ressort compl. / spring sleeve compl.	98702694
17	Übersetzungshebel kpl./ levier de transmission compl./ transmisson lever compl.	200406.001
18	Bolzen mit Gewindezapfen/ boulon avec goupille filet/ bolt with threaded pin	41004594
19	2x Scheibe A19 DIN125 PA / rondelle / washer	45908.18
	1x Scheibe A13 / rondelle / washer	D125.013
	1x Sicherungsmutter/ écrou de blocage/ lock nut	D980.004

# AUFLAUFEINRICHTUNG KF 27-A

Ausführung "GF"

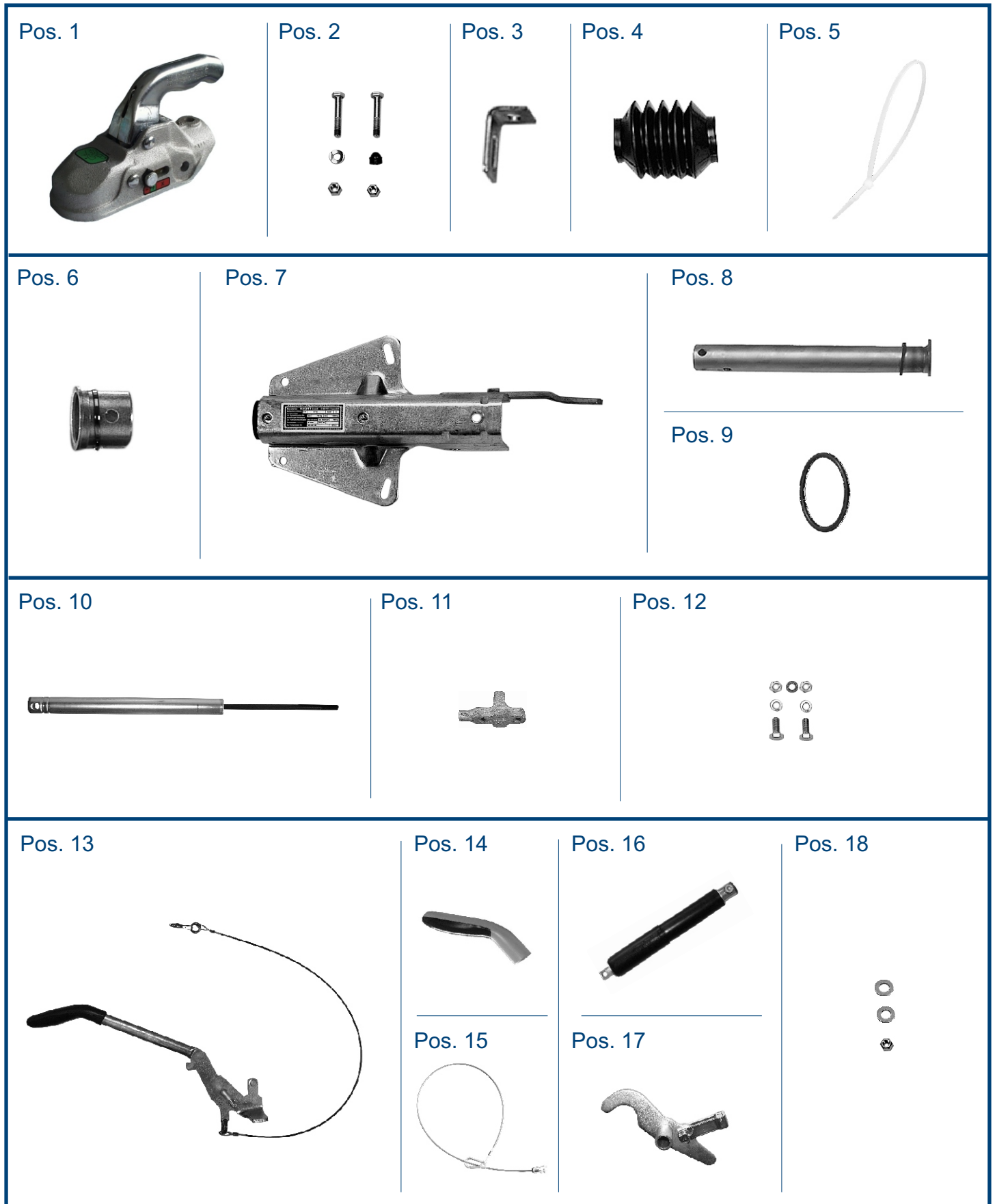

Das **Original**  
und Sie fahren mit Sicherheit weiter...

Pos	Bezeichnung	Bestell- nummer
1	Kugelumkupplung / attache a bille / ball-shaped coupling	8802409X
2	2x Sechskantschraube kpl./ vis a'six pans compl./ hex. bolt compl.	D931.022
	1x Sattelscheibe 13 verz./ disque a patin 13 galv./ caliper 13 zinc-plated	43004294
	2x Sicherungsmutter/ écrou de blocage/ lock nut	D980.004
	1x Sechskantschutzkappe / capuchonde protction Hexagonal / hex. Protective cap	45832.10
3	Halter f. Abreißeil/ support pour câble de d` attelage/ support f. breakaway cable	34006894
4	Faltenbalg/ accordeon/ bellows	69000393
5	Kabelband / câble-ruban / ribbon cable	71000194
6	Führungslager incl. Sicherungsstift / palier-guide / guide bearing	69005194
7	Gehäuse verz. / boiter compl. / housing zinc-plated	nur auf Anfrage
8	Zugstange kpl. / tirant compl./ drawbar compl. Incl. Pos. 9	98103894
9	Anschlagring / bague de butee / stop ring	69001494
10	Stoßdämpfer/ amortisseur de chocs pur/ shock absorber	87003913
11	Stoßdämpferhalter verz. / support d` amortisseure de chocs / shock absorber	21003593
12	2x Sechskantschraube kpl./ vis a'six pans compl./ hex. bolt compl.	D933.068
	2x Federring verz./ rondelle elastique/ spring ring	D127.008
	2x Sechskantmutter/ écrou a'six pans/ hex. nut	D934.011
	1x Federring verz./ rondelle elastique/ spring ring	D127.007
13	Handbremshebel kpl./ levier de frein a main compl./ handbrake lever compl.	201943.001
14	Handgriff / la poignee / handle	200027.001
15	Abreißeil komplett/ câble de rupture d'attelage compl./ breakaway cable compl.	203202.002
16	Federspeicher "GF" kpl. / douille a ressort compl. / spring sleeve compl.	201856.001
17	Übersetzungshebel kpl./ levier de transmission compl./ transmisson lever compl.	200406.001
18	2x Scheibe A19 DIN125 PA / rondelle / washer	45908.18
	1x Scheibe A13 / rondelle / washer	D125.013
	1x Sicherungsmutter/ écrou de blocage/ lock nut	D980.004

# AUFLAUFEINRICHTUNG KF 30-C

Ausführung "KH"

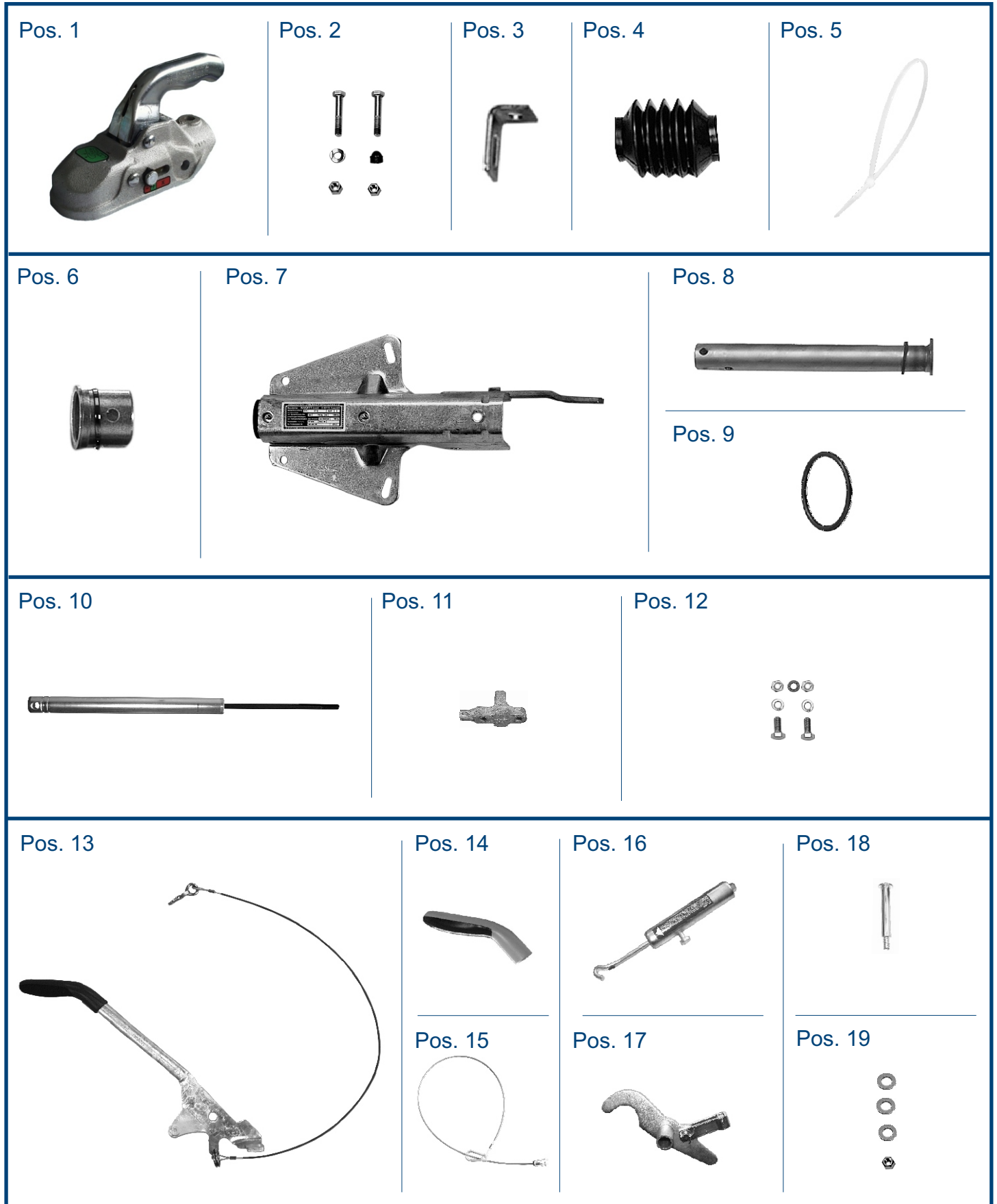

Das **Original**  
und Sie fahren mit Sicherheit weiter...

Pos	Bezeichnung	Bestell- nummer
1	Kugelumkupplung / attache a bille / ball-shaped coupling	8802539X
2	2x Sechskantschraube kpl./ vis a'six pans compl./ hex. bolt compl.	D931.035
	1x Sattelscheibe 13 verz./ disque a patin 13 galv./ caliper 13 zinc-plated	43004294
	2x Sicherungsmutter/ écrou de blocage/ lock nut	D980.007
	1x Sechskantschutzkappe / capuchonde protction Hexagonal / hex. Protective cap	45832.20
3	Halter f. Abreißeil/ support pour câble de d` attelage/ support f. breakaway cable	34006894
4	Faltenbalg/ accordeon/ bellows	69000393
5	Kabelband / câble-ruban / ribbon cable	71000194
6	Führungslager incl. Sicherungsstift / palier-guide / guide bearing	69005194
7	Gehäuse verz. / boiter compl. / housing zinc-plated	nur auf Anfrage
8	Zugstange kpl. / tirant compl./ drawbar compl. Incl. Pos. 9	98596283
9	Anschlagring / bague de butee / stop ring	69001494
10	Stoßdämpfer/ amortisseur de chocs pur/ shock absorber	87001413
11	Stoßdämpferhalter verz. / support d` amortisseure de chocs / shock absorber	34005294
12	2x Sechskantschraube kpl./ vis a'six pans compl./ hex. bolt compl.	D933.068
	2x Federring verz./ rondelle elastique/ spring ring	D127.008
	2x Sechskantmutter/ écrou a'six pans/ hex. nut	D934.011
	1x Federring verz./ rondelle elastique/ spring ring	D127.007
13	Handbremshebel kpl./ levier de frein a main compl./ handbrake lever compl.	98703193
14	Handgriff / la poignee / handle	200027.001
15	Abreißeil komplett/ câble de rupture d'attelage compl./ breakaway cable compl.	203202.002
16	Federhülse kpl. / douille a ressort compl. / spring sleeve compl.	98702694
17	Übersetzungshebel kpl./ levier de transmission compl./ transmisson lever compl.	200406.001
18	Bolzen mit Gewindezapfen/ boulon avec goupille filet/ bolt with threaded pin	41004594
19	2x Scheibe A19 DIN125 PA / rondelle / washer	45908.18
	1x Scheibe A13 / rondelle / washer	D125.013
	1x Sicherungsmutter/ écrou de blocage/ lock nut	D980.004

# AUFLAUFEINRICHTUNG KF 30-C

Ausführung "GF"

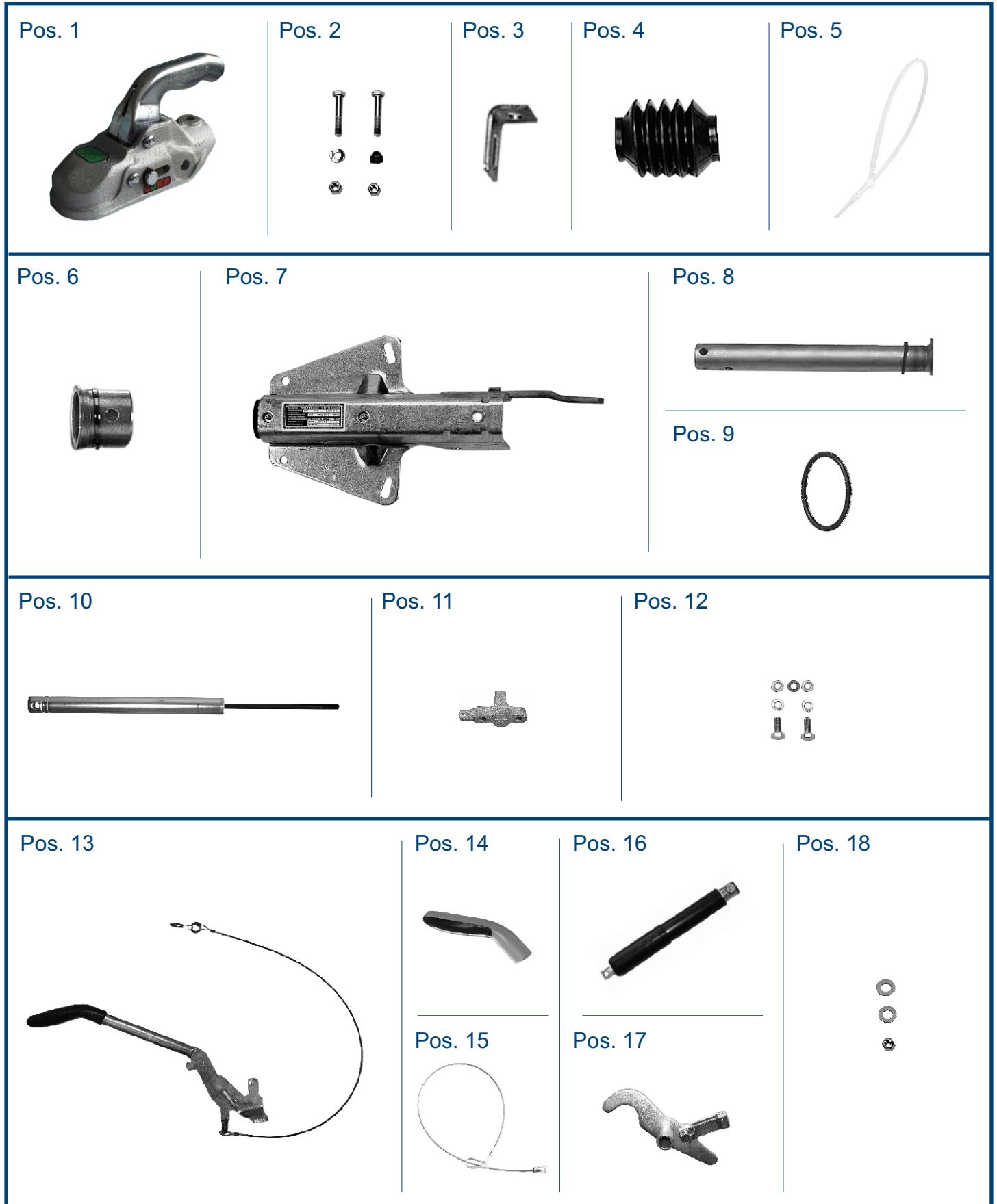



Das **Original**  
und Sie fahren mit Sicherheit weiter...

Pos	Bezeichnung	Bestell- nummer
1	Kugelumkopplung / attache a bille / ball-shaped coupling	8802539X
2	2x Sechskantschraube kpl./ vis a'six pans compl./ hex. bolt compl.	D931.035
	1x Sattelscheibe 13 verz./ disque a patin 13 galv./ caliper 13 zinc-plated	43004294
	2x Sicherungsmutter/ écrou de blocage/ lock nut	D980.007
	1x Sechskantschutzkappe / capuchonde protction Hexagonal / hex. Protective cap	45832.20
3	Halter f. AbreiÙseil/ support pour câble de d` attelage/ support f. breakaway cable	34006894
4	Faltenbalg/ accordeon/ bellows	69000393
5	Kabelband / câble-ruban / ribbon cable	71000194
6	Führungslager incl. Sicherungsstift / palier-guide / guide bearing	69005194
7	Gehäuse verz. / boiter compl. / housing zinc-plated	nur auf Anfrage
8	Zugstange kpl. / tirant compl./ drawbar compl. Incl. Pos. 9	98596283
9	Anschlagring / bague de butee / stop ring	69001494
10	StoÙdämpfer/ amortisseur de chocs pur/ shock absorber	87001413
11	StoÙdämpferhalter verz. / support d` amortisseure de chocs / shock absorber	34005294
12	2x Sechskantschraube kpl./ vis a'six pans compl./ hex. bolt compl.	D933.068
	2x Federring verz./ rondelle elastique/ spring ring	D127.008
	2x Sechskantmutter/ écrou a'six pans/ hex. nut	D934.011
	1x Federring verz./ rondelle elastique/ spring ring	D127.007
13	Handbremshebel kpl./ levier de frein a main compl./ handbrake lever compl.	202682.002
14	Handgriff / la poignee / handle	200027.001
15	AbreiÙseil komplett/ câble de rupture d'attelage compl./ breakaway cable compl.	203202.002
16	Federspeicher "GF" kpl. / douille a ressort compl. / spring sleeve compl.	202453.001
17	Übersetzungshebel kpl./ levier de transmission compl./ transmisson lever compl.	200406.001
18	1x Scheibe A19 DIN125 PA / rondelle / washer	45908.18
	1x Scheibe A13 / rondelle / washer	D125.013
	1x Sicherungsmutter/ écrou de blocage/ lock nut	D980.004

# AUFLAUFEINRICHTUNG KFG 20-A

Ausführung "KH"

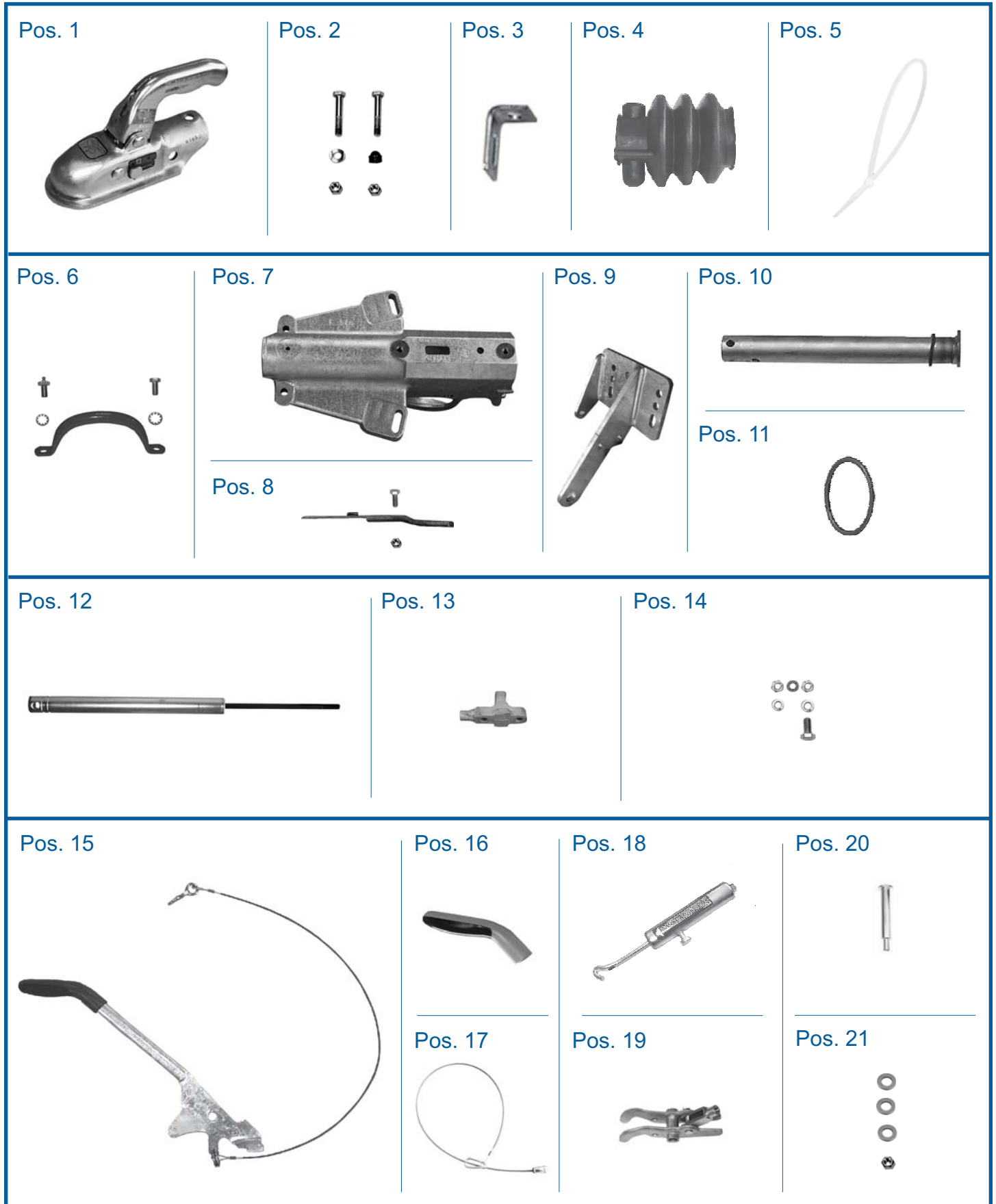

Das **Original**  
und Sie fahren mit Sicherheit weiter...

Pos	Bezeichnung	Bestell- nummer
1	Kugelkupplung / attache a bille / ball-shaped coupling	8802399X
2	2x Sechskantschraube kpl./ vis a'six pans compl./ hex. bolt compl.	D931.017
	1x Sattelscheibe 13 verz./ disque a patin 13 galv./ caliper 13 zinc-plated	43004294
	2x Sicherungsmutter/ écrou de blocage/ lock nut	D980.004
	1x Sechskantschutzkappe / capuchonde protction Hexagonal / hex. Protective cap	45832.10
3	Halter f. Abreißseil/ support pour câble de d` attelage/ support f. breakaway cable	34006894
4	Faltenbalg/ accordeon/ bellows	69004692
5	Kabelband / câble-ruban / ribbon cable	71000194
6	1x Handgriff / la poignée / handle	4300739302
	1x Sechskantschraube kpl./ vis a'six pans compl./ hex. bolt compl.	200375.002
	2x Zahnscheibe / bague d` assiette dentée / toothed disc	D6797.01
	1x Sechskantschraube kpl./ vis a'six pans compl./ hex. bolt compl.	D933.069
7	Gehäuse verz. / boiter compl. / housing zinc-plated	nur auf Anfrage
8	Druckfederhalter / support de ressort a pression / pressure spring fixing	34007083
	Sicherungsmutter/ écrou de blocage/ lock nut	7100559X
	Zylinderschraube / vis à tête cylindrique / cheese head screw	D912.039
9	Konsole kpl. mit Schrauben /	9878619X
10	Zugstange kpl. / tirant compl./ drawbar compl.	98103094
11	Anschlagring / bague de butee / stop ring	69001494
12	Stoßdämpfer/ amortisseur de chocs pur/ shock absorber	87001113
13	Stoßdämpferhalter verz. / support d` amortisseure de chocs / shock absorber	21003593
14	1x Sechskantschraube kpl./ vis a'six pans compl./ hex. bolt compl.	D933.068
	2x Federring verz./ rondelle elastique/ spring ring	D127.007
	2x Sechskantmutter/ écrou a'six pans/ hex. nut	D934.011
	1x Federring verz./ rondelle elastique/ spring ring	D127.008
15	Handbremshebel kpl./ levier de frein a main compl./ handbrake lever compl.	98703193
16	Handgriff / la poignée / handle	200027.001
17	Abreißseil komplett/ câble de rupture d'attelage compl./ breakaway cable compl.	203202.002
18	Federhülse kpl. / douille a ressort compl. / spring sleeve compl.	98702594
19	Übersetzungshebel kpl./ levier de transmission compl./ transmisson lever compl.	98812993
20	Bolzen mit Gewindezapfen/ boulon avec goupille filet/ bolt with threaded pin	41004694
21	2x Scheibe A19 DIN125 PA / rondelle / washer	45908.18
	1x Scheibe A13 / rondelle / washer	43000794
	1x Sicherungsmutter/ écrou de blocage/ lock nut	D980.004

# AUFLAUFEINRICHTUNG KFG 27-A

Ausführung "KH"

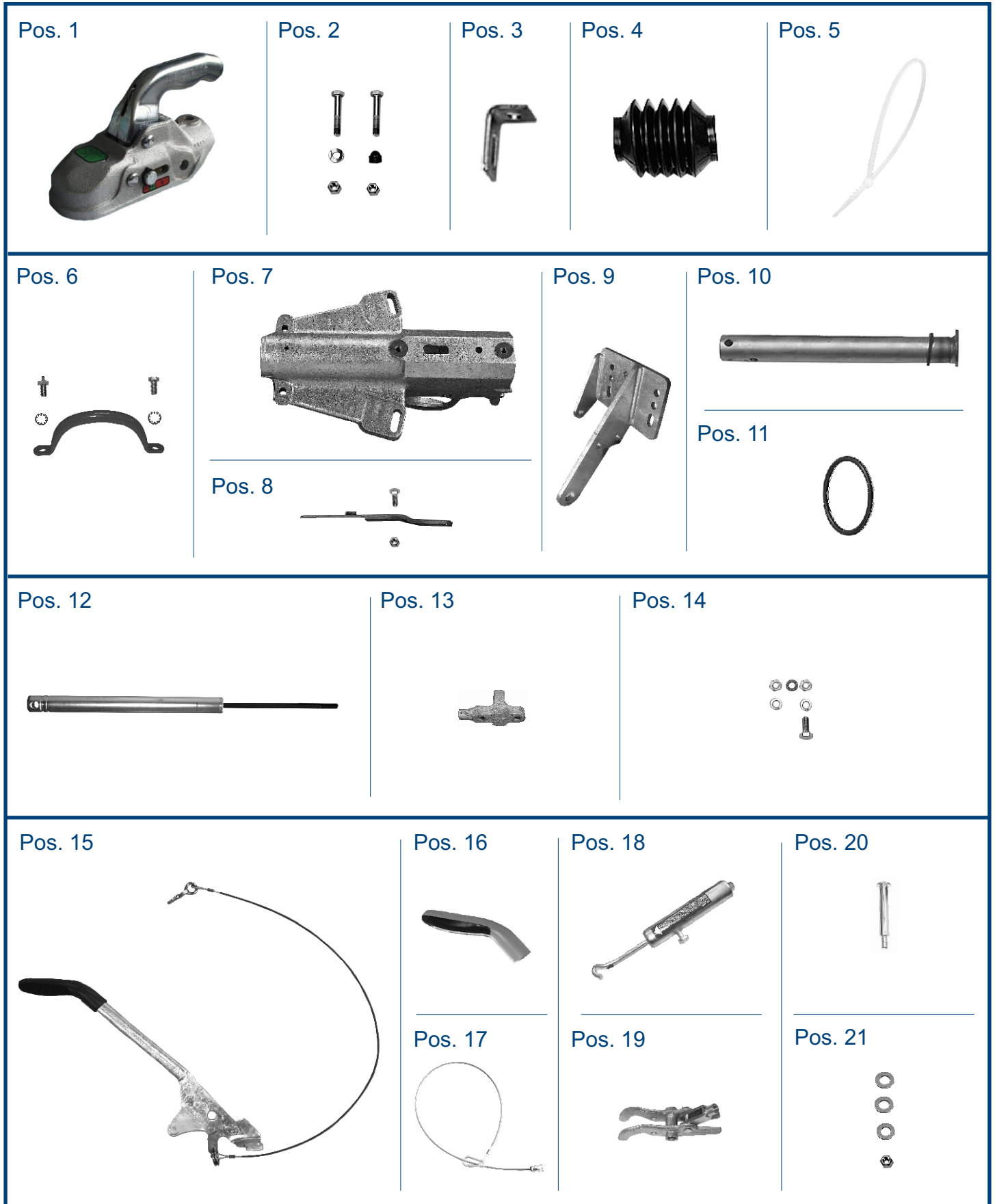

Das **Original**  
und Sie fahren mit Sicherheit weiter...

Pos	Bezeichnung	Bestell- nummer
1	Kugelkupplung / attache a bille / ball-shaped coupling	8802409X
2	2x Sechskantschraube kpl./ vis a'six pans compl./ hex. bolt compl.	D931.022
	1x Sattelscheibe 13 verz./ disque a patin 13 galv./ caliper 13 zinc-plated	43004294
	2x Sicherungsmutter/ écrou de blocage/ lock nut	D980.004
	1x Sechskantschutzkappe / capuchonde protction Hexagonal / hex. Protective cap	45832.10
3	Halter f. Abreißeil/ support pour câble de d` attelage/ support f. breakaway cable	34006894
4	Faltenbalg/ accordeon/ bellows	69000393
5	Kabelband / câble-ruban / ribbon cable	71000194
6	1x Handgriff / la poignee / handle	4300739302
	1x Sechskantschraube kpl./ vis a'six pans compl./ hex. bolt compl.	200375.002
	2x Zahnscheibe / bague d` assiette dentée / toothed disc	D6797.01
	1x Sechskantschraube kpl./ vis a'six pans compl./ hex. bolt compl.	D933.069
7	Gehäuse verz. / boiter compl. / housing zinc-plated	nur auf Anfrage
8	Druckfederhalter / support de ressort a pression / pressure spring fixing	34007083
	Sicherungsmutter/ écrou de blocage/ lock nut	7100559X
	Zylinderschraube / vis à tête cylindrique / cheese head screw	D912.039
9	Konsole kpl. mit Schrauben /	9878619X
10	Zugstange kpl. / tirant compl./ drawbar compl.	98103894
11	Anschlagring / bague de butee / stop ring	69001494
12	Stoßdämpfer/ amortisseur de chocs pur/ shock absorber	87003113
13	Stoßdämpferhalter verz. / support d` amortisseure de chocs / shock absorber	21003593
14	1x Sechskantschraube kpl./ vis a'six pans compl./ hex. bolt compl.	D933.068
	2x Federring verz./ rondelle elastique/ spring ring	D127.007
	2x Sechskantmutter/ écrou a'six pans/ hex. nut	D934.011
	1x Federring verz./ rondelle elastique/ spring ring	D127.008
15	Handbremshebel kpl./ levier de frein a main compl./ handbrake lever compl.	98703193
16	Handgriff / la poignee / handle	200027.001
17	Abreißeil komplett/ câble de rupture d'attelage compl./ breakaway cable compl.	203202.002
18	Federhülse kpl. / douille a ressort compl. / spring sleeve compl.	98702694
19	Übersetzungshebel kpl./ levier de transmission compl./ transmisson lever compl.	98812993
20	Bolzen mit Gewindezapfen/ boulon avec goupille filet/ bolt with threaded pin	41004694
21	2x Scheibe A19 DIN125 PA / rondelle / washer	45908.18
	1x Scheibe A13 / rondelle / washer	43000794
	1x Sicherungsmutter/ écrou de blocage/ lock nut	D980.004

# AUFLAUFEINRICHTUNG KFG 27-A

Ausführung "GF"

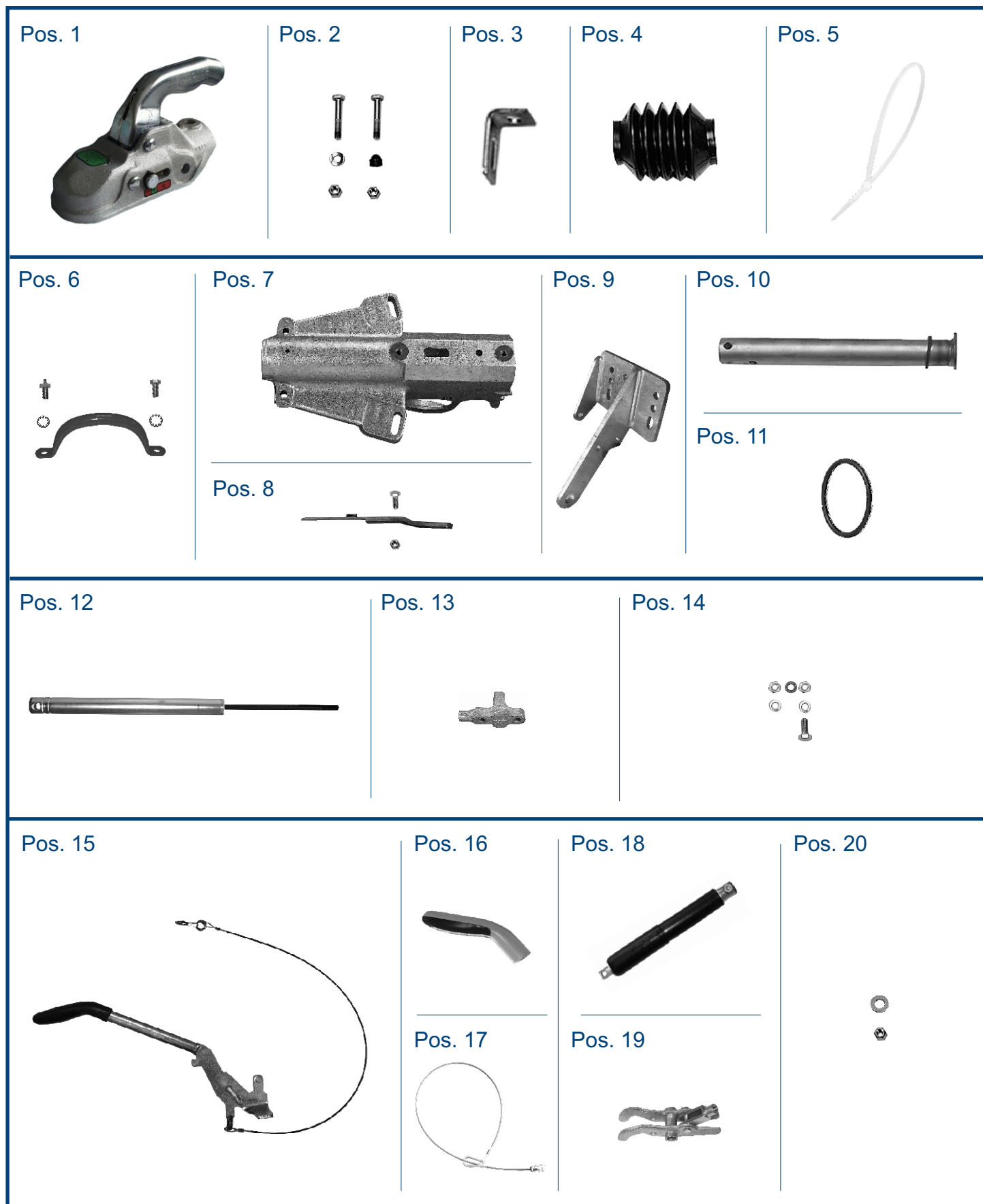

Das **Original**  
und Sie fahren mit Sicherheit weiter...

Pos	Bezeichnung	Bestell- nummer
1	Kugelkupplung / attache a bille / ball-shaped coupling	8802409X
2	2x Sechskantschraube kpl./ vis a'six pans compl./ hex. bolt compl.	D931.022
	1x Sattelscheibe 13 verz./ disque a patin 13 galv./ caliper 13 zinc-plated	43004294
	2x Sicherungsmutter/ écrou de blocage/ lock nut	D980.004
	1x Sechskantschutzkappe / capuchonde protction Hexagonal / hex. Protective cap	45832.10
3	Halter f. Abreißeil/ support pour câble de d` attelage/ support f. breakaway cable	34006894
4	Faltenbalg/ accordeon/ bellows	69000393
5	Kabelband / câble-ruban / ribbon cable	71000194
6	1x Handgriff / la poignée / handle	4300739302
	1x Sechskantschraube kpl./ vis a'six pans compl./ hex. bolt compl.	200375.002
	2x Zahnscheibe / bague d`assiette dentée / toothed disc	D6797.01
	1x Sechskantschraube kpl./ vis a'six pans compl./ hex. bolt compl.	D933.069
7	Gehäuse verz. / boiter compl. / housing zinc-plated	nur auf Anfrage
8	Halter / support de ressort a pression / pressure spring fixing	202349.003
	Sicherungsmutter/ écrou de blocage/ lock nut	7100559X
	Zylinderschraube / vis à tête cylindrique / cheese head screw	D912.039
9	Konsole kpl. mit Schrauben /	9878619X
10	Zugstange kpl. / tirant compl./ drawbar compl.	98103894
11	Anschlagring / bague de butee / stop ring	69001494
12	Stoßdämpfer/ amortisseur de chocs pur/ shock absorber	87003113
13	Stoßdämpferhalter verz. / support d` amortisseure de chocs / shock absorber	21003593
14	1x Sechskantschraube kpl./ vis a'six pans compl./ hex. bolt compl.	D933.068
	2x Federring verz./ rondelle elastique/ spring ring	D127.007
	2x Sechskantmutter/ écrou a'six pans/ hex. nut	D934.011
	1x Federring verz./ rondelle elastique/ spring ring	D127.008
15	Handbremshebel kpl./ levier de frein a main compl./ handbrake lever compl.	202682.001
16	Handgriff / la poignée / handle	200027.001
17	Abreißeil komplett/ câble de rupture d'attelage compl./ breakaway cable compl.	203202.002
18	Federspeicher kpl. / douille a ressort compl. / spring sleeve compl.	202453.001
19	Übersetzungshebel kpl./ levier de transmission compl./ transmisson lever compl.	98812993
20	1x Scheibe / rondelle / washer	45908.18
	1x Sicherungsmutter/ écrou de blocage/ lock nut	201072.001

# AUFLAUFEINRICHTUNG KFG 30-A

Ausführung "KH"

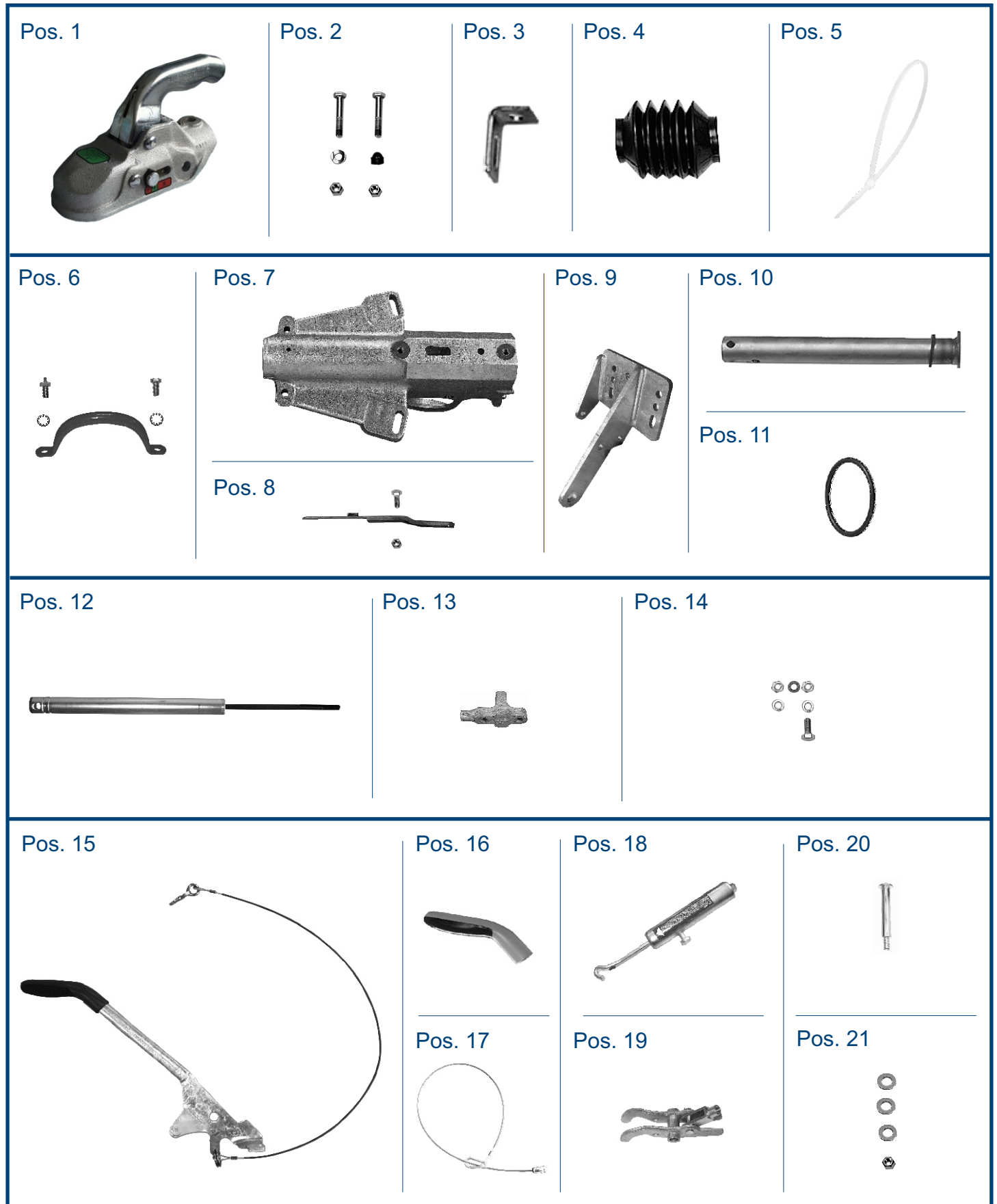



Das **Original**  
und Sie fahren mit Sicherheit weiter...

Pos	Bezeichnung	Bestell- nummer
1	Kugelumkupplung / attache a bille / ball-shaped coupling	8802529X
2	1x Sechskantschraube kpl./ vis a'six pans compl./ hex. bolt compl.	D931.022
	1x Sechskantschraube kpl./ vis a'six pans compl./ hex. bolt compl.	D931.027
	1x Sattelscheibe 13 verz./ disque a patin 13 galv./ caliper 13 zinc-plated	43004294
	1x Sicherungsmutter/ écrou de blocage/ lock nut	D980.007
	1x Sicherungsmutter/ écrou de blocage/ lock nut	D980.012
	1x Sechskantschutzkappe / capuchonde protction Hexagonal / hex. Protective cap	45832.20
3	Halter f. Abreißeil/ support pour câble de d` attelage/ support f. breakaway cable	34006894
4	Faltenbalg/ accordeon/ bellows	69000393
5	Kabelband / câble-ruban / ribbon cable	71000194
6	1x Handgriff / la poignee / handle	4300739302
	1x Sechskantschraube kpl./ vis a'six pans compl./ hex. bolt compl.	200375.002
	2x Zahnscheibe / bague d` assiette dentée / toothed disc	D6797.01
	1x Sechskantschraube kpl./ vis a'six pans compl./ hex. bolt compl.	D933.069
7	Gehäuse verz. / boiter compl. / housing zinc-plated	nur auf Anfrage
8	Druckfederhalter / support de ressort a pression / pressure spring fixing	34007083
	Sicherungsmutter/ écrou de blocage/ lock nut	7100559X
	Zylinderschraube / vis à tête cylindrique / cheese head screw	D912.039
9	Konsole kpl. mit Schrauben /	9878619X
10	Zugstange kpl. / tirant compl./ drawbar compl.	98857593
11	Anschlagring / bague de butee / stop ring	69001494
12	Stoßdämpfer/ amortisseur de chocs pur/ shock absorber	87003913
13	Stoßdämpferhalter verz. / support d` amortisseure de chocs / shock absorber	21003593
14	1x Sechskantschraube kpl./ vis a'six pans compl./ hex. bolt compl.	D933.069
	2x Federring verz./ rondelle elastique/ spring ring	D127.007
	2x Sechskantmutter/ écrou a'six pans/ hex. nut	D934.011
	1x Federring verz./ rondelle elastique/ spring ring	D127.008
15	Handbremshebel kpl./ levier de frein a main compl./ handbrake lever compl.	98703193
16	Handgriff / la poignee / handle	200027.001
17	Abreißeil komplett/ câble de rupture d'attelage compl./ breakaway cable compl.	203202.002
18	Federhülse kpl. / douille a ressort compl. / spring sleeve compl.	98702694
19	Übersetzungshebel kpl./ levier de transmission compl./ transmission lever compl.	98812993
20	Bolzen mit Gewindezapfen/ boulon avec goupille filet/ bolt with threaded pin	41004694
21	2x Scheibe A19 DIN125 PA / rondelle / washer	45908.18
	1x Scheibe A13 / rondelle / washer	43000794
	1x Sicherungsmutter/ écrou de blocage/ lock nut	D980.004

# AUFLAUFEINRICHTUNG KFG 30-A

Ausführung "GF"

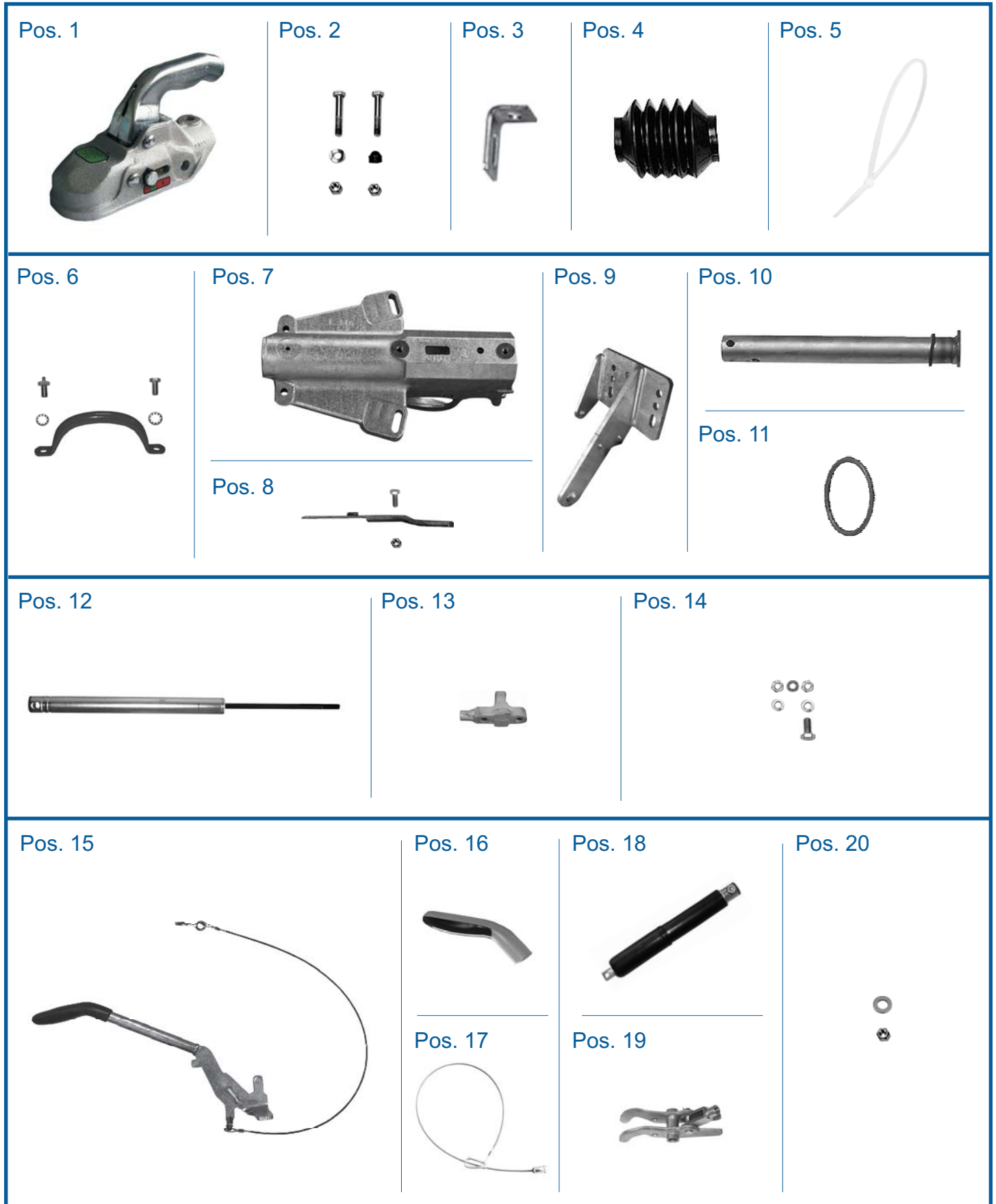

Das **Original**  
und Sie fahren mit Sicherheit weiter...

Pos	Bezeichnung	Bestell- nummer
1	Kugelkupplung / attache a bille / ball-shaped coupling	8802529X
2	1x Sechskantschraube kpl./ vis a'six pans compl./ hex. bolt compl.	D931.022
	1x Sechskantschraube kpl./ vis a'six pans compl./ hex. bolt compl.	D931.027
	1x Sattelscheibe 13 verz./ disque a patin 13 galv./ caliper 13 zinc-plated	43004294
	1x Sicherungsmutter/ écrou de blocage/ lock nut	D980.007
	1x Sicherungsmutter/ écrou de blocage/ lock nut	D980.012
	1x Sechskantschutzkappe / capuchonde protction Hexagonal / hex. Protective cap	45832.20
	3	Halter f. Abreiseil/ support pour cble de d` attelage/ support f. breakaway cable
4	Faltenbalg/ accordeon/ bellows	69000393
5	Kabelband / cble-ruban / ribbon cable	71000194
6	1x Handgriff / la poignee / handle	4300739302
	1x Sechskantschraube kpl./ vis a'six pans compl./ hex. bolt compl.	200375.002
	2x Zahnscheibe / bague d`assiette dente / toothed disc	D6797.01
	1x Sechskantschraube kpl./ vis a'six pans compl./ hex. bolt compl.	D933.069
7	Gehuse verz. / boiter compl. / housing zinc-plated	nur auf Anfrage
8	Halter / support de ressort a pression / pressure spring fixing	202349.003
	Sicherungsmutter/ écrou de blocage/ lock nut	7100559X
	Zylinderschraube / vis à tte cylindrique / cheese head screw	D912.039
9	Konsole kpl. mit Schrauben /	9878619X
10	Zugstange kpl. / tirant compl./ drawbar compl.	98857593
11	Anschlagring / bague de butee / stop ring	69001494
12	Stodmpfer/ amortisseur de chocs pur/ shock absorber	87003913
13	Stodmpferhalter verz. / support d` amortisseure de chocs / shock absorber	21003593
14	1x Sechskantschraube kpl./ vis a'six pans compl./ hex. bolt compl.	D933.069
	2x Federring verz./ rondelle elastique/ spring ring	D127.007
	2x Sechskantmutter/ écrou a'six pans/ hex. nut	D934.011
	1x Federring verz./ rondelle elastique/ spring ring	D127.008
15	Handbremshebel kpl./ levier de frein a main compl./ handbrake lever compl.	202682.001
16	Handgriff / la poignee / handle	200027.001
17	Abreiseil komplett/ cble de rupture d'attelage compl./ breakaway cable compl.	203202.002
18	Federspeicher kpl. / douille a ressort compl. / spring sleeve compl.	202453.001
19	bersetzungshebel kpl./ levier de transmission compl./ transmisson lever compl.	98812993
20	1x Scheibe / rondelle / washer	45908.18
	1x Sicherungsmutter/ écrou de blocage/ lock nut	201072.001

# AUFLAUFEINRICHTUNG KFG 30-A

Ausführung "HF" hydraulik



Das **Original**  
und Sie fahren mit Sicherheit weiter...

Pos	Bezeichnung	Bestell- nummer
1	Kugelkupplung / attache a bille / ball-shaped coupling	8802529X
2	1x Sechskantschraube kpl./ vis a'six pans compl./ hex. bolt compl.	D931.022
	1x Sechskantschraube kpl./ vis a'six pans compl./ hex. bolt compl.	D931.027
	1x Sattelscheibe 13 verz./ disque a patin 13 galv./ caliper 13 zinc-plated	43004294
	1x Sicherungsmutter/ écrou de blocage/ lock nut	D980.007
	1x Sicherungsmutter/ écrou de blocage/ lock nut	D980.012
	1x Sechskantschutzkappe / capuchonde protction Hexagonal / hex. Protective cap	45832.20
3	Halter f. Abreißeil/ support pour câble de d` attelage/ support f. breakaway cable	34006894
4	Faltenbalg/ accordeon/ bellows	69000393
5	Kabelband / câble-ruban / ribbon cable	71000194
6	1x Handgriff / la poignee / handle	4300739302
	1x Sechskantschraube kpl./ vis a'six pans compl./ hex. bolt compl.	200375.002
	2x Zahnscheibe / bague d` assiette dentée / toothed disc	D6797.01
	1x Sechskantschraube kpl./ vis a'six pans compl./ hex. bolt compl.	D933.069
7	Gehäuse verz. / boiter compl. / housing zinc-plated	nur auf Anfrage
8	Zugstange kpl. / tirant compl./ drawbar compl.	98857593
9	Anschlagring / bague de butee / stop ring	69001494
10	Stoßdämpfer/ amortisseur de chocs pur/ shock absorber	87003913
11	Stoßdämpferhalter verz. / support d` amortisseure de chocs / shock absorber	98875794
12	1x Sechskantschraube kpl./ vis a'six pans compl./ hex. bolt compl.	D933.069
	1x Federring verz./ rondelle elastique/ spring ring	D127.007
	2x Sechskantmutter/ écrou a'six pans/ hex. nut	D934.011
	1x Federring verz./ rondelle elastique/ spring ring	D127.008
14	Hydraulik Set kpl.	98593509
15	Faltenbalg/ accordeon/ bellows	46613
16	Hauptbremszylinder / cylindre de frein principal / main brake cylindre	101231.01
17	Kuperdichtring / anneau d` etanche en cuivre / copper gasket	44165
18	Ringstutzen / raccord annulaire / ring socket	36150
19	Hohlschraube / boulon creux a filet femelle / hollow screw	47011
20	Prüfanschluß / raccordement d` essai / test connection	47010
21	Kuperdichtring / anneau d` etanche en cuivre / copper gasket	47013
22	Bremsschlauch / flexible de frein / brake hose	37452.0350
23	Schraubstutzen / bouchon filet / screw socket	45780
24	Hydrospeicher / accumulateur de pression / pressure reservoir	46421.110
25	Ausgleichsbehälter / reservoir d` egalisation / expansion bracket	47348
26	Kuperdichtring / anneau d` etanche en cuivre / copper gasket	47012
27	Handbremshebel kpl./ levier de frein a main compl./ handbrake lever compl.	98866493
28	Abreißeil komplett/ câble de rupture d'attelage compl./ breakaway cable compl.	203202.002
29	Übersetzungshebel kpl./ levier de transmission compl./ transmisson lever compl.	98703693
30	Bolzen mit Gewindezapfen/ boulon avec goupille filet/ bolt with threaded pin	41006094
31	2x Scheibe A19 DIN125 PA / rondelle / washer	45908.18
	1x Scheibe A13 / rondelle / washer	43000794
	1x Sicherungsmutter/ écrou de blocage/ lock nut	D980.004

# AUFLAUFEINRICHTUNG KFG 35-D

Ausführung "KH"

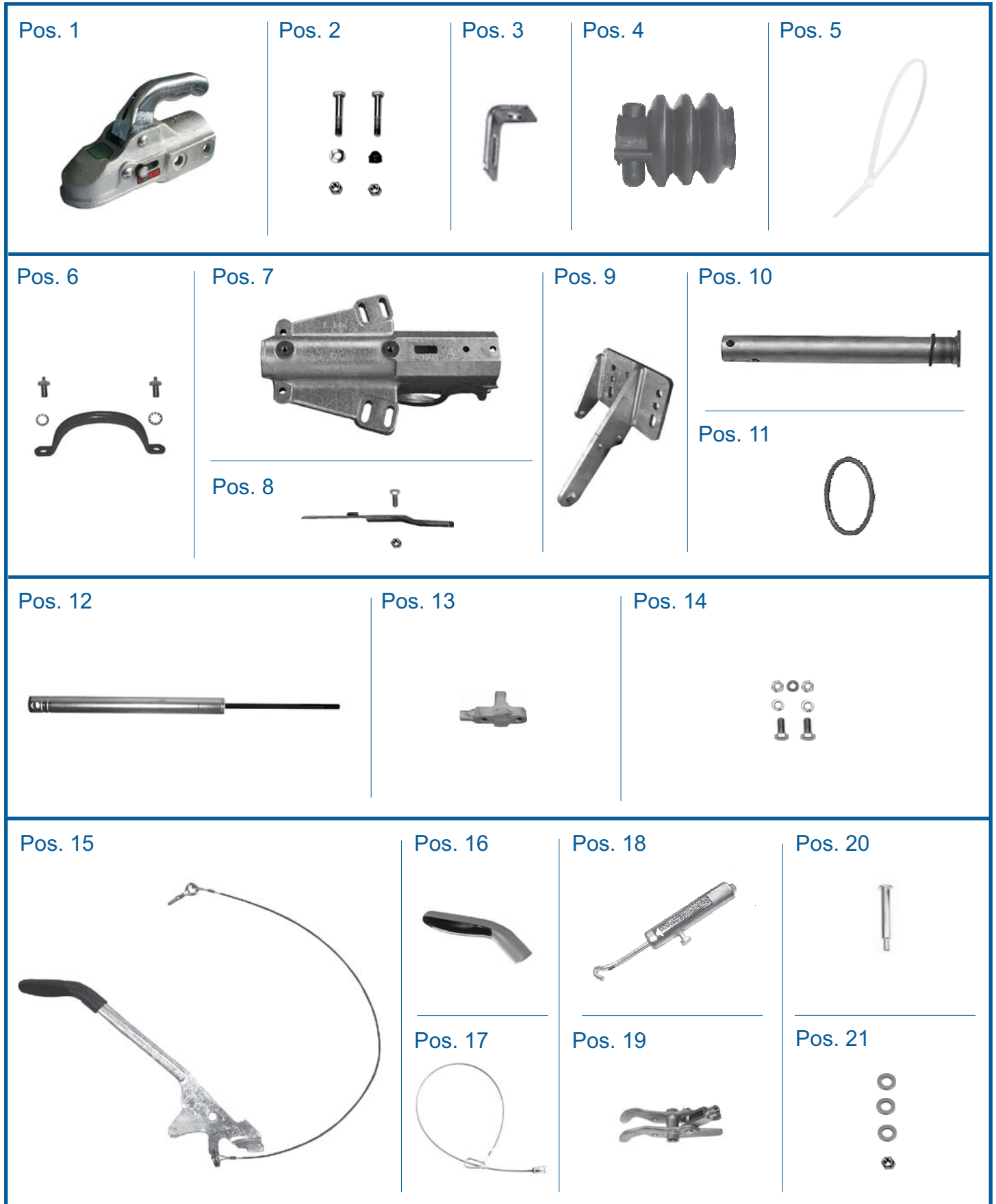

Das **Original**  
und Sie fahren mit Sicherheit weiter...

Pos	Bezeichnung	Bestell- nummer
1	Kugelkupplung / attache a bille / ball-shaped coupling	8802559X
2	2x Sechskantschraube kpl./ vis a'six pans compl./ hex. bolt compl.	D931.039
	2x Sicherungsmutter/ écrou de blocage/ lock nut	D980.007
3	1x Sechskantschutzkappe / capuchonde protction Hexagonal / hex. Protective cap	45832.20
	3 Halter f. Abreiseil/ support pour cble de d` attelage/ support f. breakaway cable	34006894
4	Faltenbalg/ accordeon/ bellows	200175.001
5	Kabelband / cble-ruban / ribbon cable	71000194
6	1x Handgriff / la poignee / handle	4300739302
	2x Sechskantschraube kpl./ vis a'six pans compl./ hex. bolt compl.	200375.002
7	2x Zahnscheibe / bague d` assiette dente / toothed disc	D6797.01
	7 Gehuse verz. / boiter compl. / housing zinc-plated	nur auf Anfrage
8	Druckfederhalter / support de ressort a pression / pressure spring fixing	34007083
	Sicherungsmutter/ écrou de blocage/ lock nut	7100559X
9	Zylinderschraube / vis à tte cylindrique / cheese head screw	D912.039
	9 Konsole kpl. mit Schrauben /	203391.001
10	Zugstange kpl. / tirant compl./ drawbar compl.	203146.001
11	Anschlagring / bague de butee / stop ring	69004394
12	Stodmpfer/ amortisseur de chocs pur/ shock absorber	87003613
13	Stodmpferhalter verz. / support d` amortisseure de chocs / shock absorber	21004793
14	2x Sechskantschraube kpl./ vis a'six pans compl./ hex. bolt compl.	D933.068
	2x Federring verz./ rondelle elastique/ spring ring	D127.007
	2x Sechskantmutter/ écrou a'six pans/ hex. nut	D934.011
15	1x Federring verz./ rondelle elastique/ spring ring	D127.008
	15 Handbremshebel kpl./ levier de frein a main compl./ handbrake lever compl.	98703193
16	Handgriff / la poignee / handle	200027.001
17	Abreiseil komplett/ cble de rupture d'attelage compl./ breakaway cable compl.	203202.002
18	Federhlse kpl. / douille a ressort compl. / spring sleeve compl.	98702694
19	bersetzungshebel kpl./ levier de transmission compl./ transmisson lever compl.	98812993
20	Bolzen mit Gewindezapfen/ boulon avec goupille filet/ bolt with threaded pin	41004694
21	2x Scheibe A19 DIN125 PA / rondelle / washer	45908.18
	1x Scheibe A13 / rondelle / washer	43000794
	1x Sicherungsmutter/ écrou de blocage/ lock nut	D980.004

# AUFLAUFEINRICHTUNG KFG 35-D

Ausführung "GF"

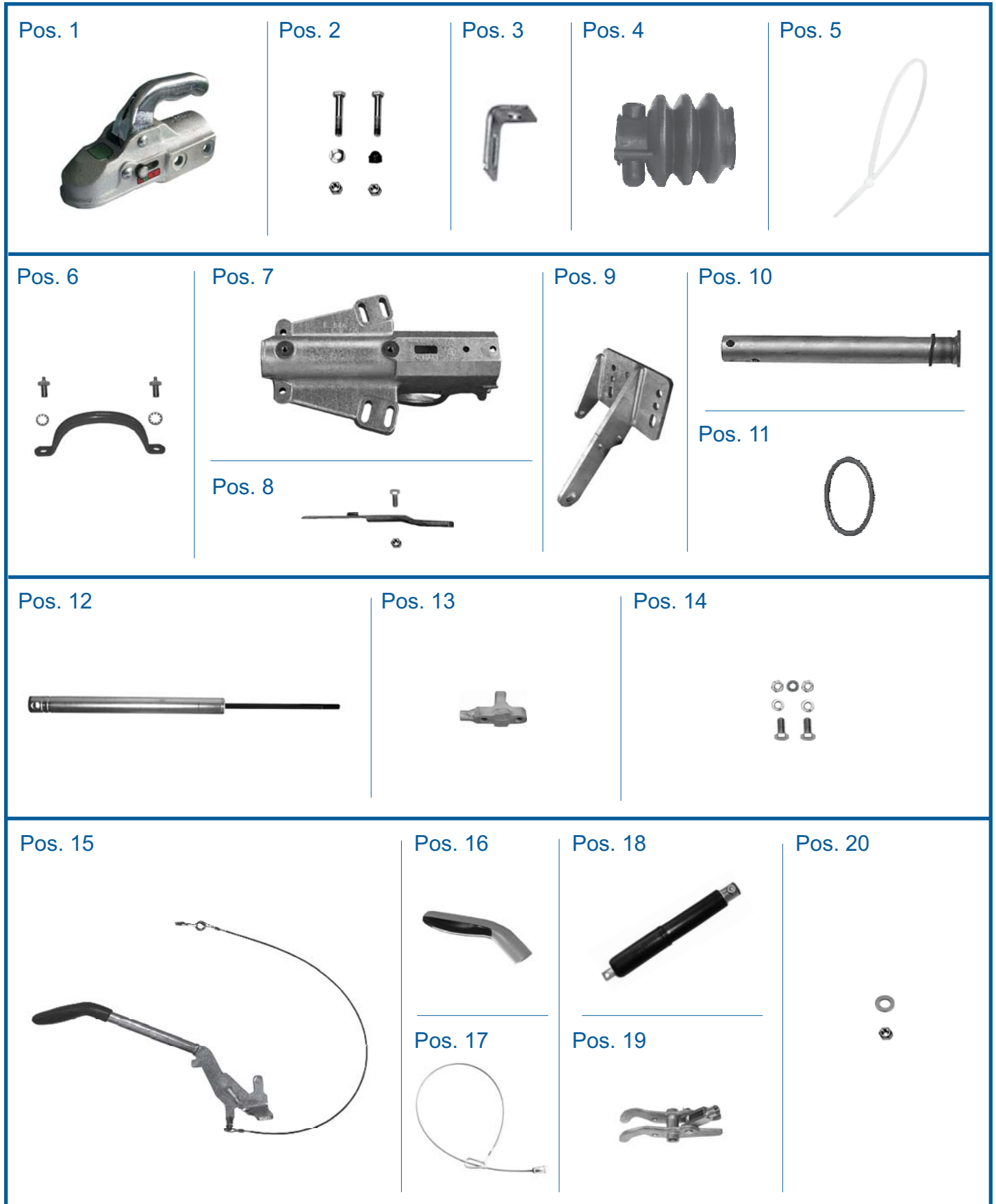



Das **Original**  
und Sie fahren mit Sicherheit weiter...

Pos	Bezeichnung	Bestell- nummer
1	Kugelkupplung / attache a bille / ball-shaped coupling	8802559X
	2x Sechskantschraube kpl./ vis a'six pans compl./ hex. bolt compl.	D931.039
2	2x Sicherungsmutter/ écrou de blocage/ lock nut	D980.007
	1x Sechskantschutzkappe / capuchonde protction Hexagonal / hex. Protective cap	45832.20
3	Halter f. Abreißseil/ support pour câble de d` attelage/ support f. breakaway cable	34006894
4	Faltenbalg/ accordeon/ bellows	200175.001
5	Kabelband / câble-ruban / ribbon cable	71000194
	1x Handgriff / la poignee / handle	4300739302
6	2x Sechskantschraube kpl./ vis a'six pans compl./ hex. bolt compl.	200375.002
	2x Zahnscheibe / bague d` assiette dentée / toothed disc	D6797.01
7	Gehäuse verz. / boiter compl. / housing zinc-plated	nur auf Anfrage
	Druckfederhalter / support de ressort a pression / pressure spring fixing	202349.003
8	Sicherungsmutter/ écrou de blocage/ lock nut	7100559X
	Zylinderschraube / vis à tête cylindrique / cheese head screw	D912.039
9	Konsole kpl. mit Schrauben /	203391.001
10	Zugstange kpl. / tirant compl./ drawbar compl.	203146.001
11	Anschlagring / bague de butee / stop ring	69004394
12	Stoßdämpfer/ amortisseur de chocs pur/ shock absorber	87003613
13	Stoßdämpferhalter verz. / support d` amortisseure de chocs / shock absorber	21004793
	2x Sechskantschraube kpl./ vis a'six pans compl./ hex. bolt compl.	D933.068
14	2x Federring verz./ rondelle elastique/ spring ring	D127.007
	2x Sechskantmutter/ écrou a'six pans/ hex. nut	D934.011
	1x Federring verz./ rondelle elastique/ spring ring	D127.008
15	Handbremshebel kpl./ levier de frein a main compl./ handbrake lever compl.	202682.001
16	Handgriff / la poignee / handle	200027.001
17	Abreißseil komplett/ câble de rupture d'attelage compl./ breakaway cable compl.	203202.002
18	Federspeicher kpl. / douille a ressort compl. / spring sleeve compl.	202453.001
19	Übersetzungshebel kpl./ levier de transmission compl./ transmisson lever compl.	98812993
	1x Scheibe / rondelle / washer	45908.18
20	1x Sicherungsmutter/ écrou de blocage/ lock nut	201072.001

# AUFLAUFEINRICHTUNG KFG 35-A

Ausführung "HF" hydraulik

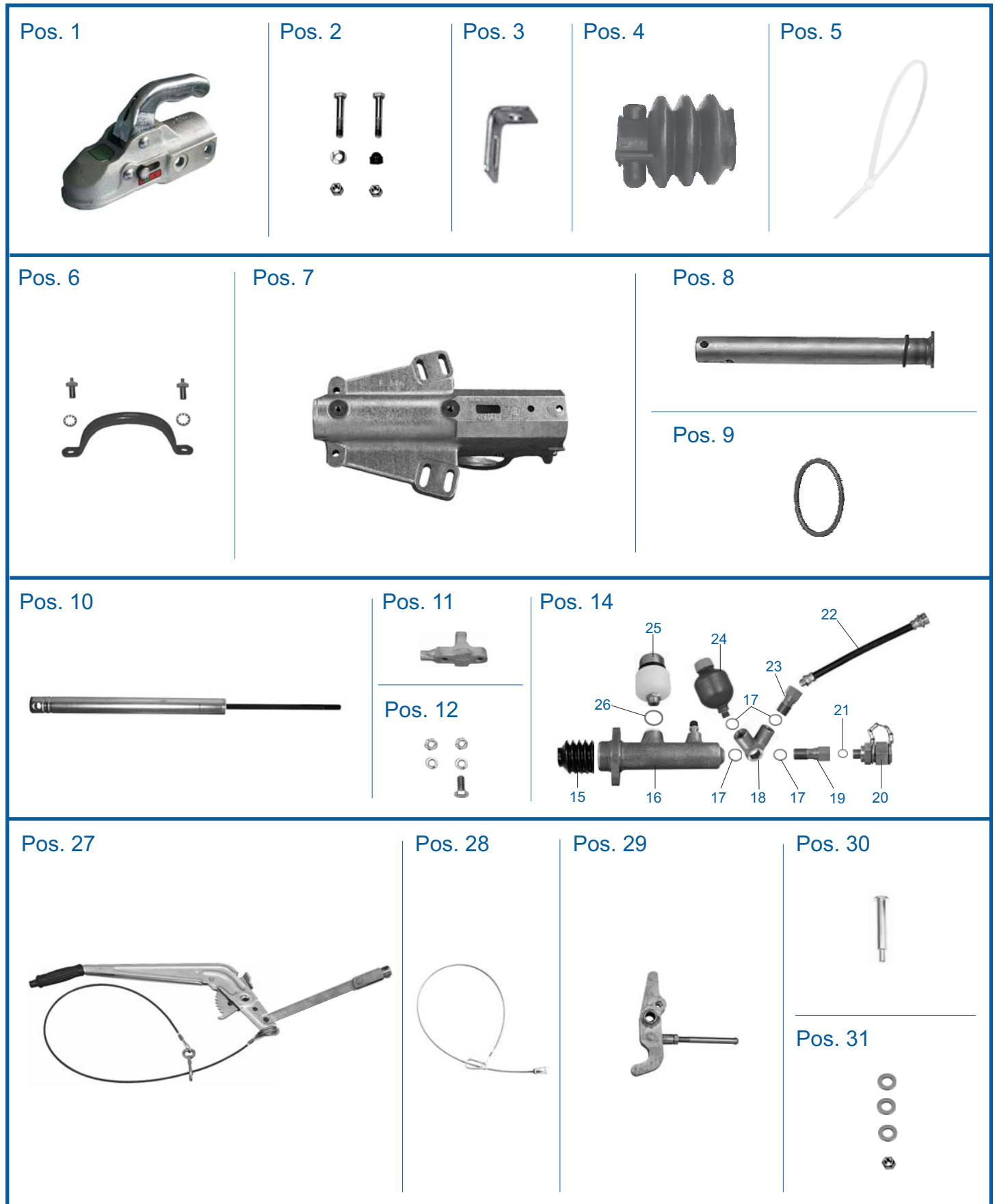

Das **Original**  
und Sie fahren mit Sicherheit weiter...

Pos	Bezeichnung	Bestell- nummer
1	Kugelumkupplung / attache a bille / ball-shaped coupling	8802559X
	2x Sechskantschraube kpl./ vis a'six pans compl./ hex. bolt compl.	D931.039
2	2x Sicherungsmutter/ écrou de blocage/ lock nut	D980.007
	1x Sechskantschutzkappe / capuchonde protction Hexagonal / hex. Protective cap	45832.20
3	Halter f. AbreiÙseil/ support pour câble de d` attelage/ support f. breakaway cable	34006894
4	Faltenbalg/ accordeon/ bellows	200175.001
5	Kabelband / câble-ruban / ribbon cable	71000194
	1x Handgriff / la poignee / handle	4300739302
6	2x Sechskantschraube kpl./ vis a'six pans compl./ hex. bolt compl.	200375.002
	2x Zahnscheibe / bague d` assiette dentée / toothed disc	D6797.01
7	Gehäuse verz. / boiter compl. / housing zinc-plated	nur auf Anfrage
8	Zugstange kpl. / tirant compl./ drawbar compl.	203146.001
9	Anschlagring / bague de butee / stop ring	69004394
10	StoÙdämpfer/ amortisseur de chocs pur/ shock absorber	87003613
11	StoÙdämpferhalter verz. / support d` amortisseure de chocs / shock absorber	98863994
	1x Sechskantschraube kpl./ vis a'six pans compl./ hex. bolt compl.	D933.068
12	1x Federring verz./ rondelle elastique/ spring ring	D127.007
	2x Sechskantmutter/ écrou a'six pans/ hex. nut	D934.011
	1x Federring verz./ rondelle elastique/ spring ring	D127.008
14	Hydraulik Set kpl.	98593509
15	Faltenbalg/ accordeon/ bellows	46613
16	Hauptbremszylinder / cylindre de frein principal / main brake cylindre	101231.01
17	Kuperdichtring / anneau d` etanche en cuivre / copper gasket	44165
18	Ringstutzen / raccord annulaire / ring socket	36150
19	Hohlschraube / boulon creux a filet femelle / hollow screw	47011
20	Prüfanschluß / raccordement d` essai / test connection	47010
21	Kuperdichtring / anneau d` etanche en cuivre / copper gasket	47013
22	Bremsschlauch / flexible de frein / brake hose	37452.0350
23	Schraubstutzen / bouchon filet / screw socket	45780
24	Hydrospeicher / accumulateur de pression / pressure reservoir	46421.110
25	Ausgleichsbehälter / reservoir d` egalisation / expansion bracket	47348
26	Kuperdichtring / anneau d` etanche en cuivre / copper gasket	47012
27	Handbremshebel kpl./ levier de frein a main compl./ handbrake lever compl.	98866493
28	AbreiÙseil komplett/ câble de rupture d'attelage compl./ breakaway cable compl.	203202.002
29	Übersetzungshebel kpl./ levier de transmission compl./ transmisson lever compl.	98703693
30	Bolzen mit Gewindezapfen/ boulon avec goupille filet/ bolt with threaded pin	41006094
	2x Scheibe A19 DIN125 PA / rondelle / washer	45908.18
31	1x Scheibe A13 / rondelle / washer	43000794
	1x Sicherungsmutter/ écrou de blocage/ lock nut	D980.004

# AUFLAUFEINRICHTUNG KRV 7,5-C

Ausführung "KH"

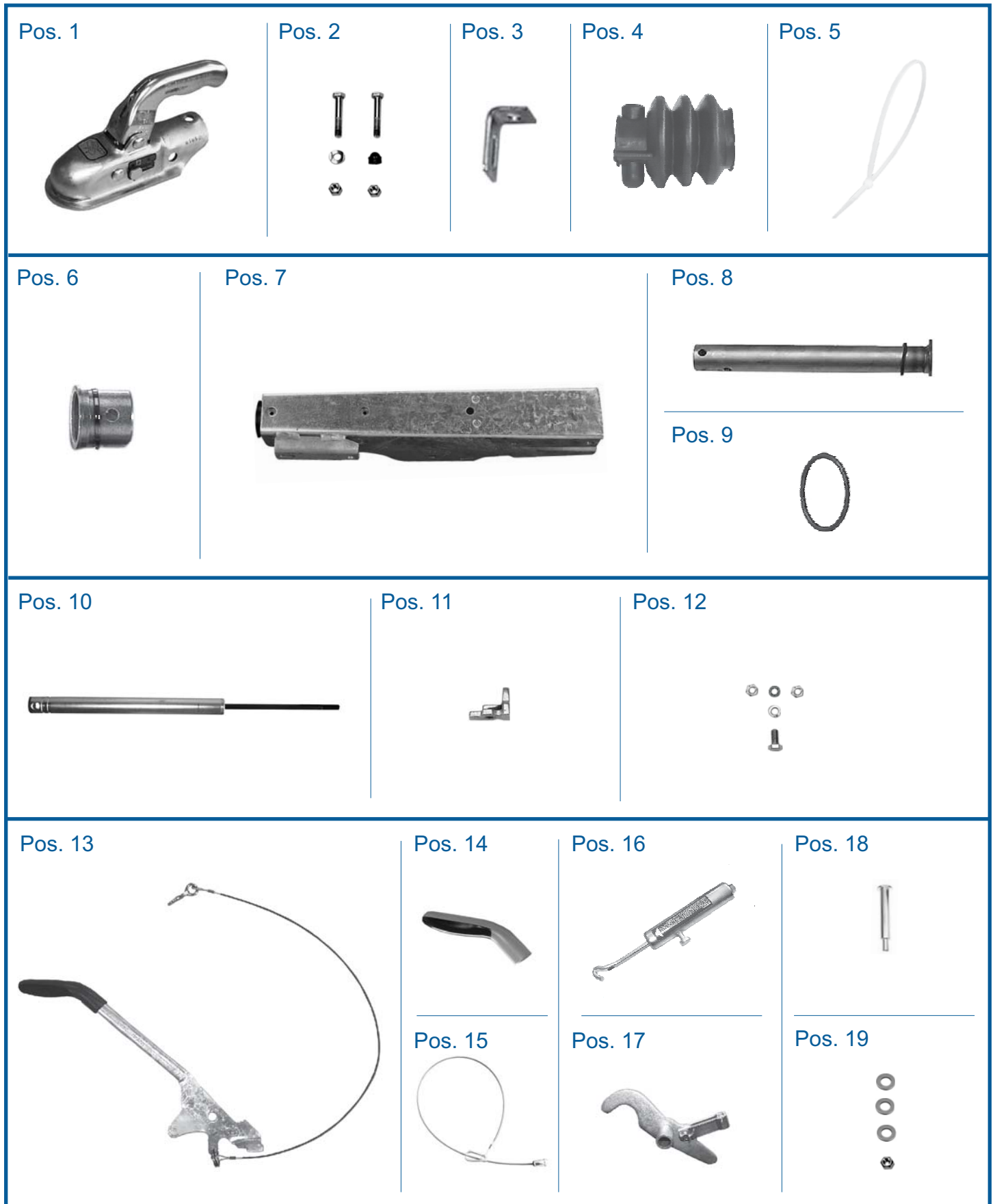

Das **Original**  
und Sie fahren mit Sicherheit weiter...

Pos	Bezeichnung	Bestell- nummer
1	Kugelumkupplung / attache a bille / ball-shaped coupling	8802429X
2	2x Sechskantschraube kpl./ vis a'six pans compl./ hex. bolt compl.	D931.017
	1x Sattelscheibe 13 verz./ disque a patin 13 galv./ caliper 13 zinc-plated	43004294
	2x Sicherungsmutter/ écrou de blocage/ lock nut	D980.004
	1x Sechskantschutzkappe / capuchonde protction Hexagonal / hex. Protective cap	45832.10
3	Halter f. Abreißeil/ support pour câble de d` attelage/ support f. breakaway cable	34006894
4	Faltenbalg/ accordeon/ bellows	69004692
5	Kabelband / câble-ruban / ribbon cable	71000194
6	Führungslager incl. Sicherungsstift / palier-guide / guide bearing	69005094
7	Gehäuse verz. / boiter compl. / housing zinc-plated	nur auf Anfrage
8	Zugstange kpl. / tirant compl./ drawbar compl. Incl. Pos. 9	98103094
9	Anschlagring / bague de butee / stop ring	69001494
10	Stoßdämpfer/ amortisseur de chocs pur/ shock absorber	87000313
11	Stoßdämpferhalter verz. / support d` amortisseure de chocs / shock absorber	21003494
12	1x Sechskantschraube kpl./ vis a'six pans compl./ hex. bolt compl.	D933.068
	1x Federring verz./ rondelle elastique/ spring ring	D127.008
	2x Sechskantmutter/ écrou a'six pans/ hex. nut	D934.011
	1x Federring verz./ rondelle elastique/ spring ring	D127.007
13	Handbremshebel kpl./ levier de frein a main compl./ handbrake lever compl.	98703193
14	Handgriff / la poignee / handle	200027.001
15	Abreißeil komplett/ câble de rupture d'attelage compl./ breakaway cable compl.	203202.002
16	Federhülse kpl. / douille a ressort compl. / spring sleeve compl.	98702594
17	Übersetzungshebel kpl./ levier de transmission compl./ transmisson lever compl.	98722483
18	Bolzen mit Gewindezapfen/ boulon avec goupille filet/ bolt with threaded pin	41004494
19	2x Scheibe A19 DIN125 PA / rondelle / washer	45908.18
	1x Scheibe A13 / rondelle / washer	D125.013
	1x Sicherungsmutter/ écrou de blocage/ lock nut	D980.004

# AUFLAUFEINRICHTUNG KRV 7,5-C

Ausführung "GF"

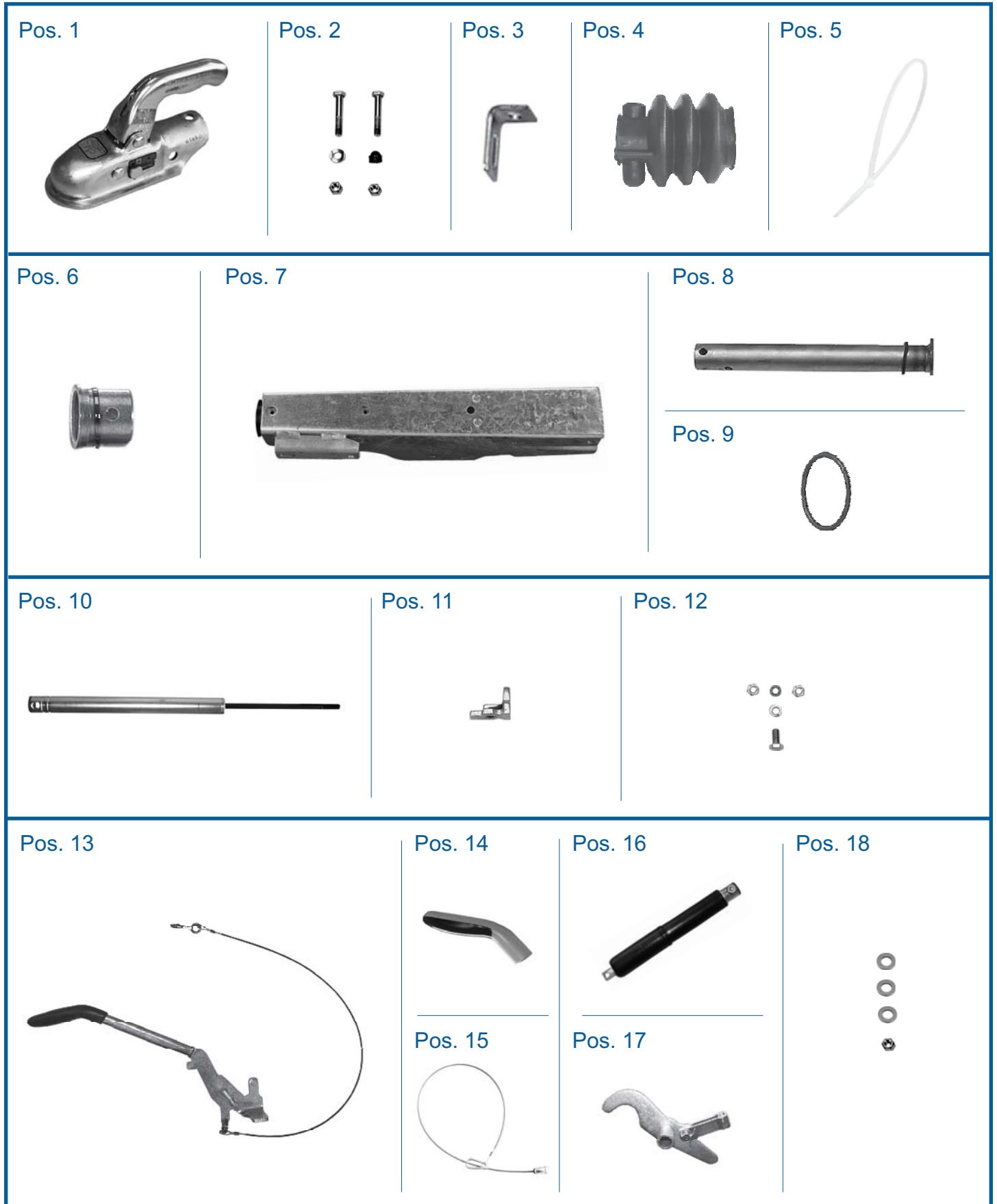

Das **Original**  
und Sie fahren mit Sicherheit weiter...

Pos	Bezeichnung	Bestell- nummer
1	Kugelkupplung / attache a bille / ball-shaped coupling	8802429X
2	2x Sechskantschraube kpl./ vis a'six pans compl./ hex. bolt compl.	D931.017
	1x Sattelscheibe 13 verz./ disque a patin 13 galv./ caliper 13 zinc-plated	43004294
	2x Sicherungsmutter/ écrou de blocage/ lock nut	D980.004
	1x Sechskantschutzkappe / capuchonde protction Hexagonal / hex. Protective cap	45832.10
3	Halter f. Abreißeil/ support pour câble de d` attelage/ support f. breakaway cable	34006894
4	Faltenbalg/ accordeon/ bellows	69004692
5	Kabelband / câble-ruban / ribbon cable	71000194
6	Führungslager incl. Sicherungsstift / palier-guide / guide bearing	69005094
7	Gehäuse verz. / boiter compl. / housing zinc-plated	nur auf Anfrage
8	Zugstange kpl. / tirant compl./ drawbar compl. Incl. Pos. 9	98103094
9	Anschlagring / bague de butee / stop ring	69001494
10	Stoßdämpfer/ amortisseur de chocs pur/ shock absorber	87000313
11	Stoßdämpferhalter verz. / support d` amortisseure de chocs / shock absorber	21003494
12	1x Sechskantschraube kpl./ vis a'six pans compl./ hex. bolt compl.	D933.068
	1x Federring verz./ rondelle elastique/ spring ring	D127.008
	2x Sechskantmutter/ écrou a'six pans/ hex. nut	D934.011
	1x Federring verz./ rondelle elastique/ spring ring	D127.007
13	Handbremshebel kpl./ levier de frein a main compl./ handbrake lever compl.	201943.001
14	Handgriff / la poignee / handle	200027.001
15	Abreißeil komplett/ câble de rupture d'attelage compl./ breakaway cable compl.	203202.002
16	Federspeicher "GF" kpl. / douille a ressort compl. / spring sleeve compl.	201856.001
17	Übersetzungshebel kpl./ levier de transmission compl./ transmisson lever compl.	98722483
18	1x Scheibe / rondelle / washer	45908.18
	1x Scheibe / rondelle / washer	43000794
	1x Scheibe / rondelle / washer	43001494
	1x Sicherungsmutter/ écrou de blocage/ lock nut	D980.004

# AUFLAUFEINRICHTUNG KRV 13-C

Ausführung "KH"

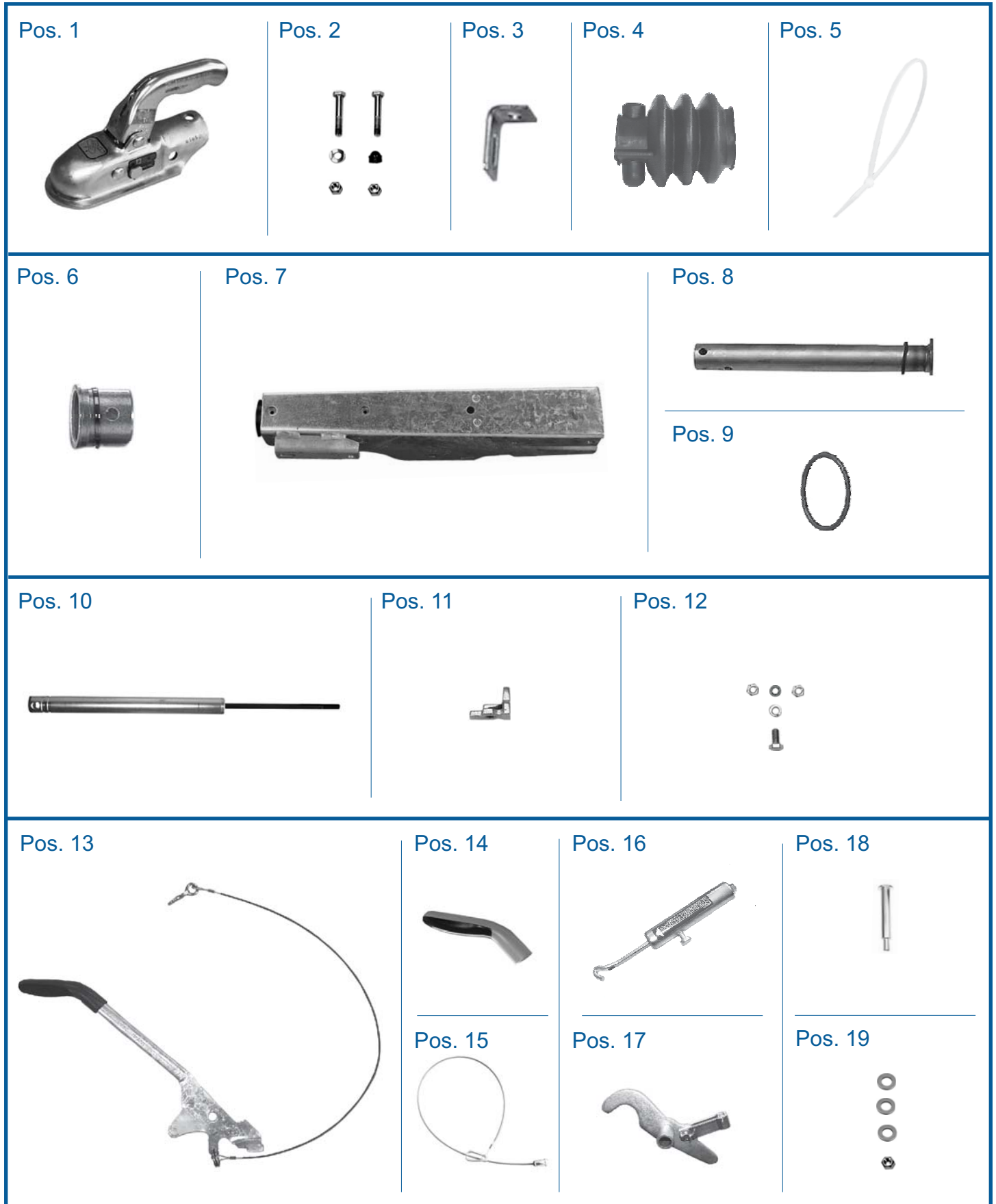



Das **Original**  
und Sie fahren mit Sicherheit weiter...

Pos	Bezeichnung	Bestell- nummer
1	Kugelkupplung / attache a bille / ball-shaped coupling	8802429X
2	2x Sechskantschraube kpl./ vis a'six pans compl./ hex. bolt compl.	D931.017
	1x Sattelscheibe 13 verz./ disque a patin 13 galv./ caliper 13 zinc-plated	43004294
	2x Sicherungsmutter/ écrou de blocage/ lock nut	D980.004
	1x Sechskantschutzkappe / capuchonde protction Hexagonal / hex. Protective cap	45832.10
3	Halter f. Abreißeil/ support pour câble de d` attelage/ support f. breakaway cable	34006894
4	Faltenbalg/ accordeon/ bellows	69004692
5	Kabelband / câble-ruban / ribbon cable	71000194
6	Führungslager incl. Sicherungsstift / palier-guide / guide bearing	69005094
7	Gehäuse verz. / boiter compl. / housing zinc-plated	nur auf Anfrage
8	Zugstange kpl. / tirant compl./ drawbar compl. Incl. Pos. 9	98103094
9	Anschlagring / bague de butee / stop ring	69001494
10	Stoßdämpfer/ amortisseur de chocs pur/ shock absorber	87000713
11	Stoßdämpferhalter verz. / support d` amortisseure de chocs / shock absorber	21003494
12	1x Sechskantschraube kpl./ vis a'six pans compl./ hex. bolt compl.	D933.068
	1x Federring verz./ rondelle elastique/ spring ring	D127.008
	2x Sechskantmutter/ écrou a'six pans/ hex. nut	D934.011
	1x Federring verz./ rondelle elastique/ spring ring	D127.007
13	Handbremshebel kpl./ levier de frein a main compl./ handbrake lever compl.	98703193
14	Handgriff / la poignee / handle	200027.001
15	Abreißeil komplett/ câble de rupture d'attelage compl./ breakaway cable compl.	203202.002
16	Federhülse kpl. / douille a ressort compl. / spring sleeve compl.	98702594
17	Übersetzungshebel kpl./ levier de transmission compl./ transmisson lever compl.	98722483
18	Bolzen mit Gewindezapfen/ boulon avec goupille filet/ bolt with threaded pin	41004494
19	2x Scheibe A19 DIN125 PA / rondelle / washer	45908.18
	1x Scheibe A13 / rondelle / washer	D125.013
	1x Sicherungsmutter/ écrou de blocage/ lock nut	D980.004

# AUFLAUFEINRICHTUNG KRV 13-C

Ausführung "GF"

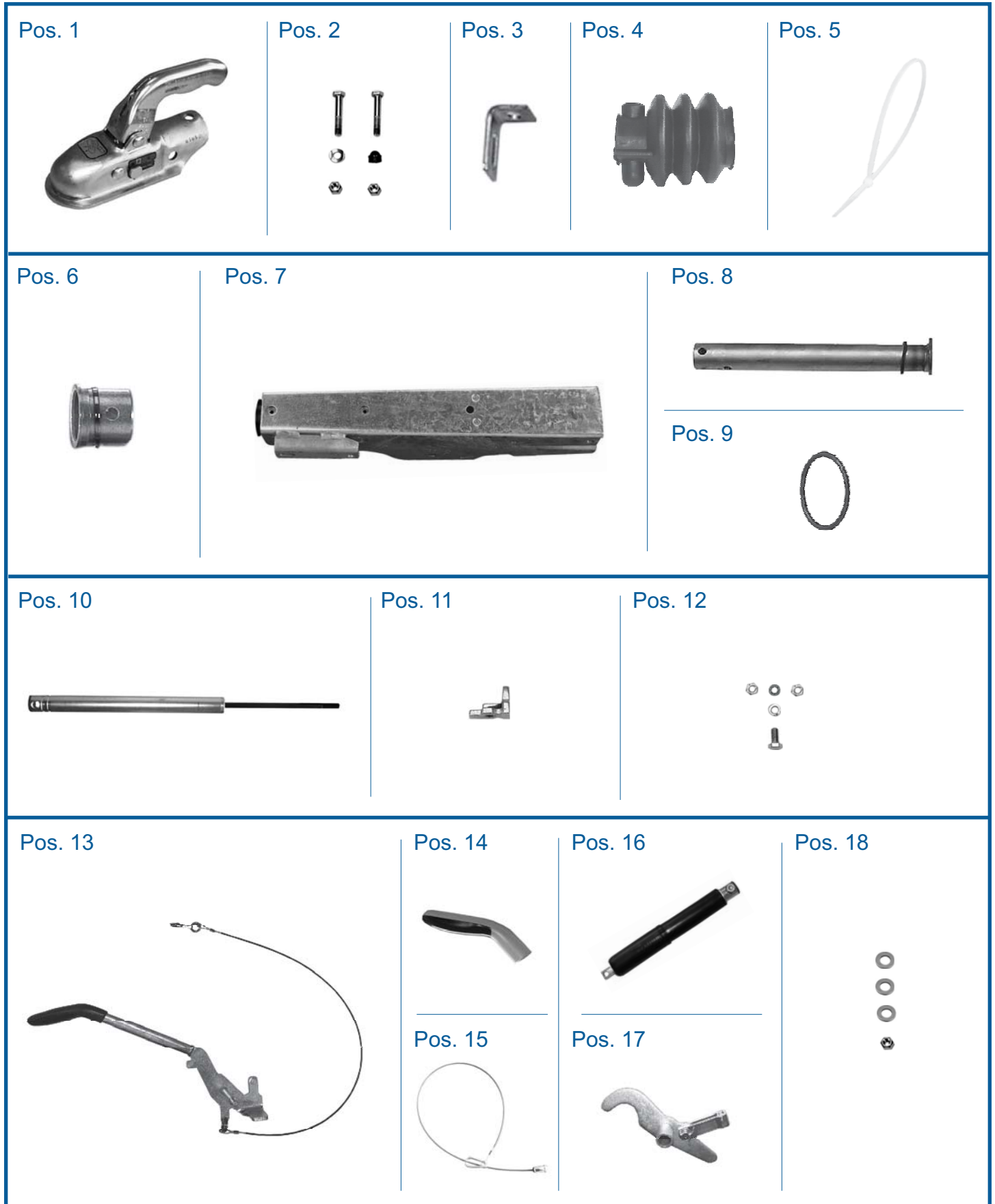

Das **Original**  
und Sie fahren mit Sicherheit weiter...

Pos	Bezeichnung	Bestell- nummer
1	Kugelumkupplung / attache a bille / ball-shaped coupling	8802429X
2	2x Sechskantschraube kpl./ vis a'six pans compl./ hex. bolt compl.	D931.017
	1x Sattelscheibe 13 verz./ disque a patin 13 galv./ caliper 13 zinc-plated	43004294
	2x Sicherungsmutter/ écrou de blocage/ lock nut	D980.004
	1x Sechskantschutzkappe / capuchonde protction Hexagonal / hex. Protective cap	45832.10
3	Halter f. AbreiÙseil/ support pour câble de d` attelage/ support f. breakaway cable	34006894
4	Faltenbalg/ accordeon/ bellows	69004692
5	Kabelband / câble-ruban / ribbon cable	71000194
6	Führungslager incl. Sicherungsstift / palier-guide / guide bearing	69005094
7	Gehäuse verz. / boiter compl. / housing zinc-plated	nur auf Anfrage
8	Zugstange kpl. / tirant compl./ drawbar compl. Incl. Pos. 9	98103094
9	Anschlagring / bague de butee / stop ring	69001494
10	StoÙdämpfer/ amortisseur de chocs pur/ shock absorber	87000713
11	StoÙdämpferhalter verz. / support d` amortisseure de chocs / shock absorber	21003494
12	1x Sechskantschraube kpl./ vis a'six pans compl./ hex. bolt compl.	D933.068
	1x Federring verz./ rondelle elastique/ spring ring	D127.008
	2x Sechskantmutter/ écrou a'six pans/ hex. nut	D934.011
	1x Federring verz./ rondelle elastique/ spring ring	D127.007
13	Handbremshebel kpl./ levier de frein a main compl./ handbrake lever compl.	201943.001
14	Handgriff / la poignee / handle	200027.001
15	AbreiÙseil komplett/ câble de rupture d'attelage compl./ breakaway cable compl.	203202.002
16	Federspeicher "GF" kpl. / douille a ressort compl. / spring sleeve compl.	201856.001
17	Übersetzungshebel kpl./ levier de transmission compl./ transmisson lever compl.	98722483
18	1x Scheibe / rondelle / washer	45908.18
	1x Scheibe / rondelle / washer	43000794
	1x Scheibe / rondelle / washer	43001494
	1x Sicherungsmutter/ écrou de blocage/ lock nut	D980.004

# AUFLAUFEINRICHTUNG KRV 17-C

Ausführung "KH"

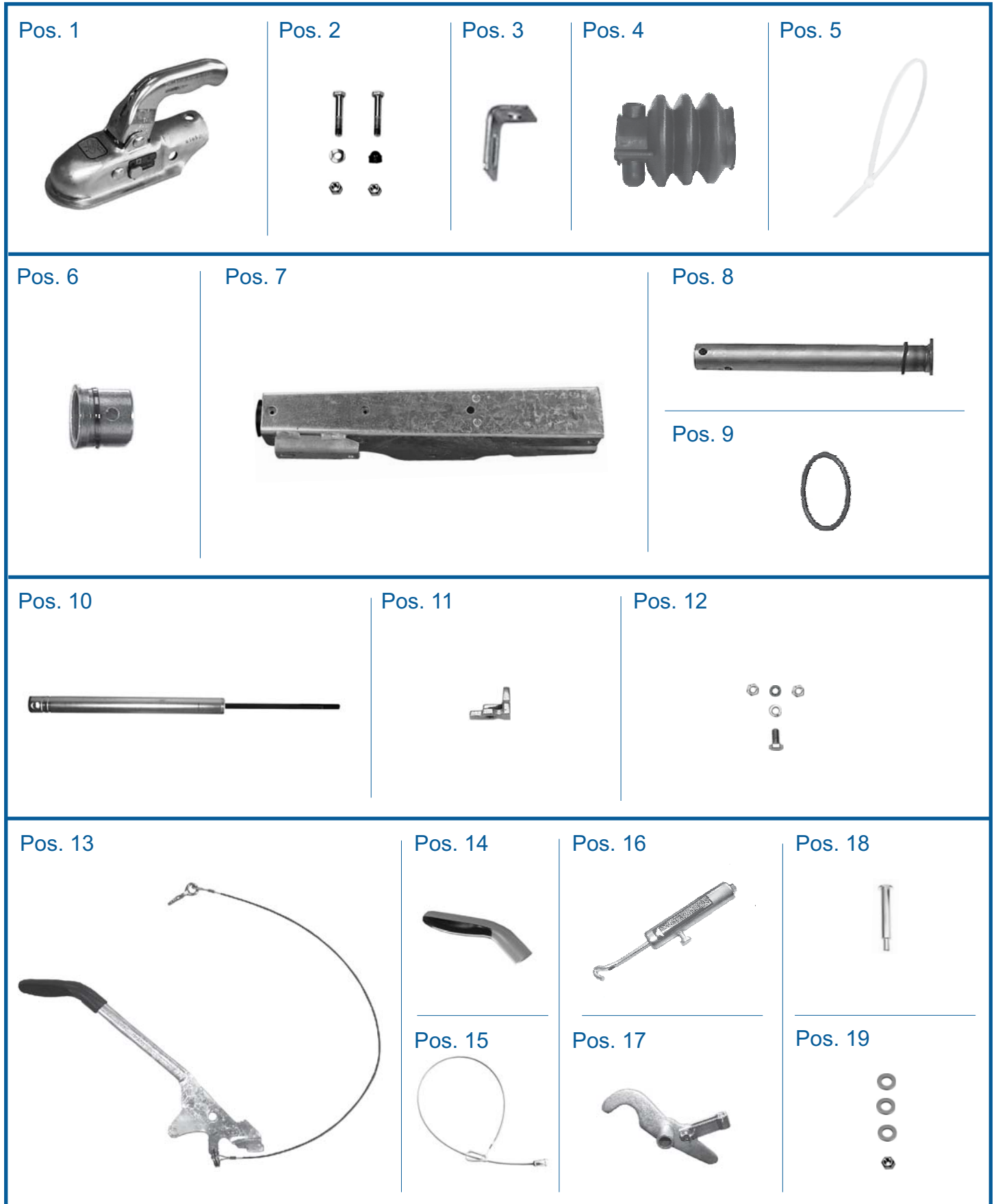

Das **Original**  
und Sie fahren mit Sicherheit weiter...

Pos	Bezeichnung	Bestell- nummer
1	Kugelkupplung / attache a bille / ball-shaped coupling	8802399X
2	2x Sechskantschraube kpl./ vis a'six pans compl./ hex. bolt compl.	D931.017
	1x Sattelscheibe 13 verz./ disque a patin 13 galv./ caliper 13 zinc-plated	43004294
	2x Sicherungsmutter/ écrou de blocage/ lock nut	D980.004
	1x Sechskantschutzkappe / capuchonde protction Hexagonal / hex. Protective cap	45832.10
3	Halter f. Abreißeil/ support pour câble de d` attelage/ support f. breakaway cable	34006894
4	Faltenbalg/ accordeon/ bellows	69004692
5	Kabelband / câble-ruban / ribbon cable	71000194
6	Führungslager incl. Sicherungsstift / palier-guide / guide bearing	69005094
7	Gehäuse verz. / boiter compl. / housing zinc-plated	nur auf Anfrage
8	Zugstange kpl. / tirant compl./ drawbar compl. Incl. Pos. 9	98103094
9	Anschlagring / bague de butee / stop ring	69001494
10	Stoßdämpfer/ amortisseur de chocs pur/ shock absorber	87001113
11	Stoßdämpferhalter verz. / support d` amortisseure de chocs / shock absorber	21003494
12	1x Sechskantschraube kpl./ vis a'six pans compl./ hex. bolt compl.	D933.068
	1x Federring verz./ rondelle elastique/ spring ring	D127.008
	2x Sechskantmutter/ écrou a'six pans/ hex. nut	D934.011
	1x Federring verz./ rondelle elastique/ spring ring	D127.007
13	Handbremshebel kpl./ levier de frein a main compl./ handbrake lever compl.	98703193
14	Handgriff / la poignee / handle	200027.001
15	Abreißeil komplett/ câble de rupture d'attelage compl./ breakaway cable compl.	203202.002
16	Federhülse kpl. / douille a ressort compl. / spring sleeve compl.	98702594
17	Übersetzungshebel kpl./ levier de transmission compl./ transmisson lever compl.	98722483
18	Bolzen mit Gewindezapfen/ boulon avec goupille filet/ bolt with threaded pin	41004494
19	2x Scheibe A19 DIN125 PA / rondelle / washer	45908.18
	1x Scheibe A13 / rondelle / washer	D125.013
	1x Sicherungsmutter/ écrou de blocage/ lock nut	D980.004

# AUFLAUFEINRICHTUNG KRV 17-C

Ausführung "GF"

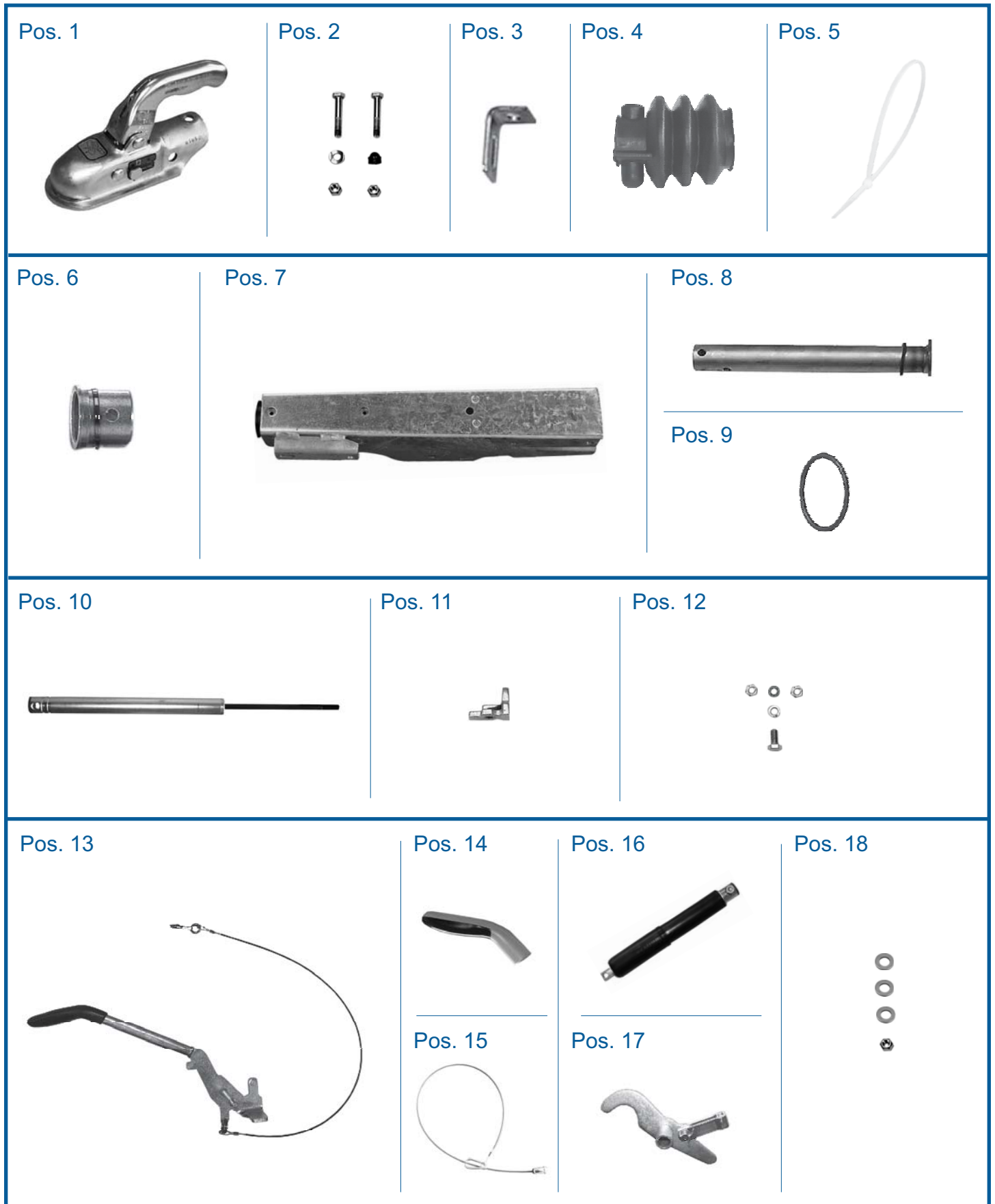

Das **Original**  
und Sie fahren mit Sicherheit weiter...

Pos	Bezeichnung	Bestell- nummer
1	Kugelkupplung / attache a bille / ball-shaped coupling	8802399X
2	2x Sechskantschraube kpl./ vis a'six pans compl./ hex. bolt compl.	D931.017
	1x Sattelscheibe 13 verz./ disque a patin 13 galv./ caliper 13 zinc-plated	43004294
	2x Sicherungsmutter/ écrou de blocage/ lock nut	D980.004
	1x Sechskantschutzkappe / capuchonde protction Hexagonal / hex. Protective cap	45832.10
3	Halter f. Abreißeil/ support pour câble de d` attelage/ support f. breakaway cable	34006894
4	Faltenbalg/ accordeon/ bellows	69004692
5	Kabelband / câble-ruban / ribbon cable	71000194
6	Führungslager incl. Sicherungsstift / palier-guide / guide bearing	69005094
7	Gehäuse verz. / boiter compl. / housing zinc-plated	nur auf Anfrage
8	Zugstange kpl. / tirant compl./ drawbar compl. Incl. Pos. 9	98103094
9	Anschlagring / bague de butee / stop ring	69001494
10	Stoßdämpfer/ amortisseur de chocs pur/ shock absorber	87001113
11	Stoßdämpferhalter verz. / support d` amortisseure de chocs / shock absorber	21003494
12	1x Sechskantschraube kpl./ vis a'six pans compl./ hex. bolt compl.	D933.068
	1x Federring verz./ rondelle elastique/ spring ring	D127.008
	2x Sechskantmutter/ écrou a'six pans/ hex. nut	D934.011
	1x Federring verz./ rondelle elastique/ spring ring	D127.007
13	Handbremshebel kpl./ levier de frein a main compl./ handbrake lever compl.	201943.001
14	Handgriff / la poignee / handle	200027.001
15	Abreißeil komplett/ câble de rupture d'attelage compl./ breakaway cable compl.	203202.002
16	Federspeicher "GF" kpl. / douille a ressort compl. / spring sleeve compl.	201856.001
17	Übersetzungshebel kpl./ levier de transmission compl./ transmisson lever compl.	98722483
18	1x Scheibe / rondelle / washer	45908.18
	1x Scheibe / rondelle / washer	43000794
	1x Scheibe / rondelle / washer	43001494
	1x Sicherungsmutter/ écrou de blocage/ lock nut	D980.004

# AUFLAUFEINRICHTUNG KRV 20-A

Ausführung "KH"

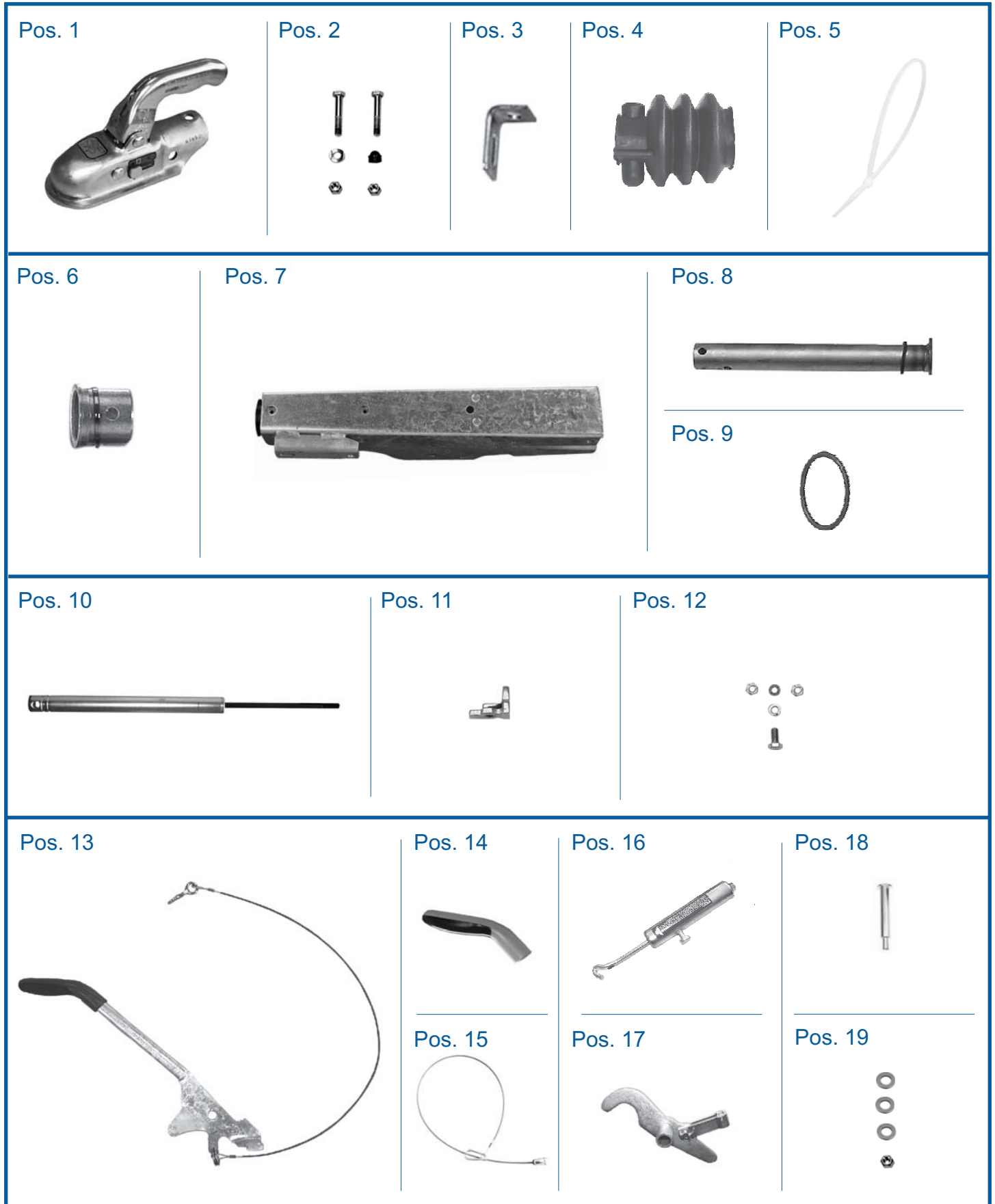



Das **Original**  
und Sie fahren mit Sicherheit weiter...

Pos	Bezeichnung	Bestell- nummer
1	Kugelkupplung / attache a bille / ball-shaped coupling	8802399X
2	2x Sechskantschraube kpl./ vis a'six pans compl./ hex. bolt compl.	D931.017
	1x Sattelscheibe 13 verz./ disque a patin 13 galv./ caliper 13 zinc-plated	43004294
	2x Sicherungsmutter/ écrou de blocage/ lock nut	D980.004
	1x Sechskantschutzkappe / capuchonde protction Hexagonal / hex. Protective cap	45832.10
3	Halter f. Abreißeil/ support pour câble de d` attelage/ support f. breakaway cable	34006894
4	Faltenbalg/ accordeon/ bellows	69004692
5	Kabelband / câble-ruban / ribbon cable	71000194
6	Führungslager incl. Sicherungsstift / palier-guide / guide bearing	69005094
7	Gehäuse verz. / boiter compl. / housing zinc-plated	nur auf Anfrage
8	Zugstange kpl. / tirant compl./ drawbar compl. Incl. Pos. 9	98103094
9	Anschlagring / bague de butee / stop ring	69001494
10	Stoßdämpfer/ amortisseur de chocs pur/ shock absorber	87001113
11	Stoßdämpferhalter verz. / support d` amortisseure de chocs / shock absorber	21003494
12	1x Sechskantschraube kpl./ vis a'six pans compl./ hex. bolt compl.	D933.068
	1x Federring verz./ rondelle elastique/ spring ring	D127.008
	2x Sechskantmutter/ écrou a'six pans/ hex. nut	D934.011
	1x Federring verz./ rondelle elastique/ spring ring	D127.007
13	Handbremshebel kpl./ levier de frein a main compl./ handbrake lever compl.	98703193
14	Handgriff / la poignee / handle	200027.001
15	Abreißeil komplett/ câble de rupture d'attelage compl./ breakaway cable compl.	203202.002
16	Federhülse kpl. / douille a ressort compl. / spring sleeve compl.	98702594
17	Übersetzungshebel kpl./ levier de transmission compl./ transmisson lever compl.	98722483
18	Bolzen mit Gewindezapfen/ boulon avec goupille filet/ bolt with threaded pin	41006094
19	2x Scheibe A19 DIN125 PA / rondelle / washer	45908.18
	1x Scheibe A13 / rondelle / washer	D125.013
	1x Sicherungsmutter/ écrou de blocage/ lock nut	D980.004

# AUFLAUFEINRICHTUNG KRV 20-A / A1

Ausführung "GF"

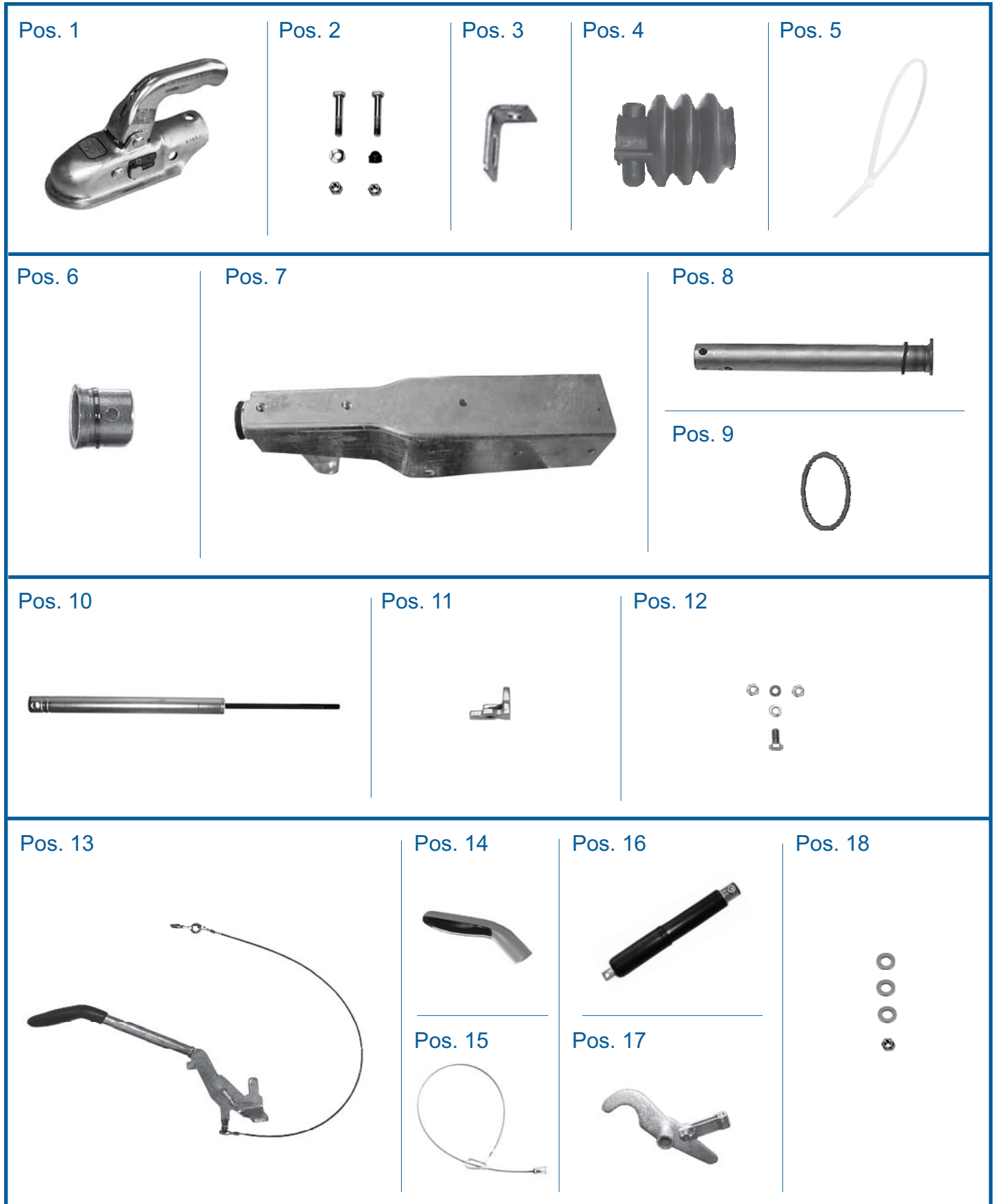

Das **Original**  
und Sie fahren mit Sicherheit weiter...

Pos	Bezeichnung	Bestell- nummer
1	Kugelkupplung / attache a bille / ball-shaped coupling	8802399X
2	2x Sechskantschraube kpl./ vis a'six pans compl./ hex. bolt compl.	D931.017
	1x Sattelscheibe 13 verz./ disque a patin 13 galv./ caliper 13 zinc-plated	43004294
	2x Sicherungsmutter/ écrou de blocage/ lock nut	D980.004
	1x Sechskantschutzkappe / capuchonde protction Hexagonal / hex. Protective cap	45832.10
3	Halter f. Abreißeil/ support pour câble de d` attelage/ support f. breakaway cable	34006894
4	Faltenbalg/ accordeon/ bellows	69004692
5	Kabelband / câble-ruban / ribbon cable	71000194
6	Führungslager incl. Sicherungsstift / palier-guide / guide bearing	69005094
7	Gehäuse verz. / boiter compl. / housing zinc-plated	nur auf Anfrage
8	Zugstange kpl. / tirant compl./ drawbar compl. Incl. Pos. 9	98103094
9	Anschlagring / bague de butee / stop ring	69001494
10	Stoßdämpfer/ amortisseur de chocs pur/ shock absorber	87001113
11	Stoßdämpferhalter verz. / support d` amortisseure de chocs / shock absorber	21003494
12	1x Sechskantschraube kpl./ vis a'six pans compl./ hex. bolt compl.	D933.068
	1x Federring verz./ rondelle elastique/ spring ring	D127.008
	2x Sechskantmutter/ écrou a'six pans/ hex. nut	D934.011
	1x Federring verz./ rondelle elastique/ spring ring	D127.007
13	Handbremshebel kpl./ levier de frein a main compl./ handbrake lever compl.	202969.001
14	Handgriff / la poignee / handle	200027.001
15	Abreißeil komplett/ câble de rupture d'attelage compl./ breakaway cable compl.	203202.002
16	Federspeicher "GF" kpl. / douille a ressort compl. / spring sleeve compl.	201856.001
17	Übersetzungshebel kpl./ levier de transmission compl./ transmisson lever compl.	98722483
18	1x Scheibe / rondelle / washer	45908.18
	1x Scheibe / rondelle / washer	D125.013
	1x Scheibe / rondelle / washer	43001494
	1x Sicherungsmutter/ écrou de blocage/ lock nut	D980.004

# AUFLAUFEINRICHTUNG KRV 30-B

Ausführung "KH"

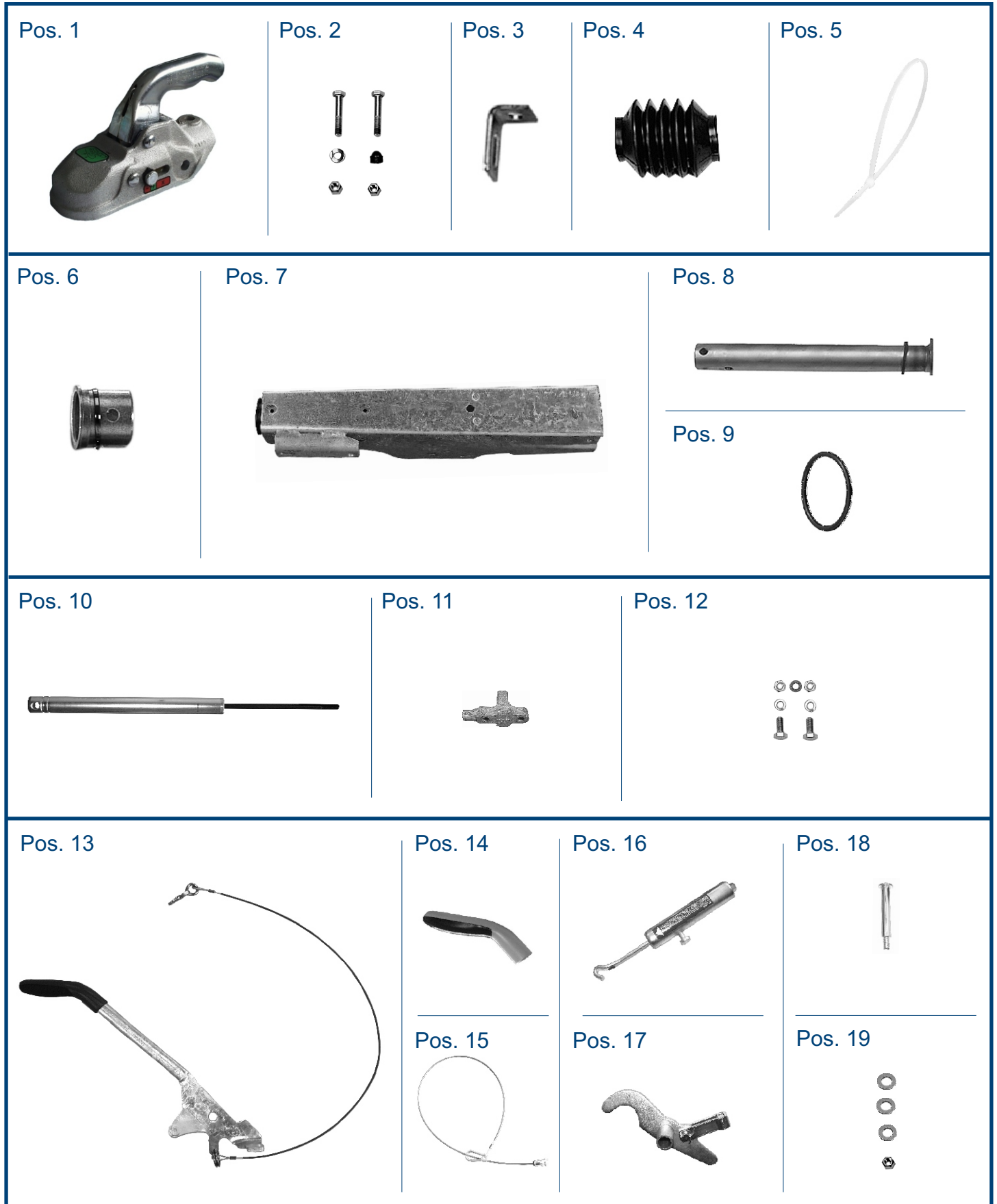

Das **Original**  
und Sie fahren mit Sicherheit weiter...

Pos	Bezeichnung	Bestell- nummer
1	Kugelkupplung / attache a bille / ball-shaped coupling	8802539X
2	1x Sechskantschraube kpl./ vis a'six pans compl./ hex. bolt compl.	D931.022
	1x Sechskantschraube kpl./ vis a'six pans compl./ hex. bolt compl.	D931.027
	1x Sattelscheibe 13 verz./ disque a patin 13 galv./ caliper 13 zinc-plated	43004294
	1x Sicherungsmutter/ écrou de blocage/ lock nut	D980.004
	1x Sicherungsmutter/ écrou de blocage/ lock nut	D980.007
	1x Sechskantschutzkappe / capuchonde protction Hexagonal / hex. Protective cap	45832.20
3	Halter f. Abreißeil/ support pour câble de d` attelage/ support f. breakaway cable	34006894
4	Faltenbalg/ accordeon/ bellows	69000393
5	Kabelband / câble-ruban / ribbon cable	71000194
6	Führungslager incl. Sicherungsstift / palier-guide / guide bearing	69005194
7	Gehäuse verz. / boiter compl. / housing zinc-plated	nur auf Anfrage
8	Zugstange kpl. / tirant compl./ drawbar compl. Incl. Pos. 9	98857593
9	Anschlagring / bague de butee / stop ring	69001494
10	Stoßdämpfer/ amortisseur de chocs pur/ shock absorber	87003913
11	Stoßdämpferhalter verz. / support d` amortisseure de chocs / shock absorber	21003593
12	2x Sechskantschraube kpl./ vis a'six pans compl./ hex. bolt compl.	D933.068
	2x Federring verz./ rondelle elastique/ spring ring	D127.008
	2x Sechskantmutter/ écrou a'six pans/ hex. nut	D934.011
	1x Federring verz./ rondelle elastique/ spring ring	D127.007
13	Handbremshebel kpl./ levier de frein a main compl./ handbrake lever compl.	200086.001
14	Handgriff / la poignee / handle	200027.001
15	Abreißeil komplett/ câble de rupture d'attelage compl./ breakaway cable compl.	203202.002
16	Federhülse kpl. / douille a ressort compl. / spring sleeve compl.	98702694
17	Übersetzungshebel kpl./ levier de transmission compl./ transmisson lever compl.	98722483
18	Bolzen mit Gewindezapfen/ boulon avec goupille filet/ bolt with threaded pin	41021994
19	2x Scheibe A19 DIN125 PA / rondelle / washer	45908.18
	1x Scheibe A13 / rondelle / washer	D125.013
	1x Sicherungsmutter/ écrou de blocage/ lock nut	D980.004

# AUFLAUFEINRICHTUNG KRV 30-A / B

Ausführung "GF"



Das **Original**  
und Sie fahren mit Sicherheit weiter...

Pos	Bezeichnung	Bestell- nummer
1	Kugelkupplung / attache a bille / ball-shaped coupling	8802539X
	1x Sechskantschraube kpl./ vis a'six pans compl./ hex. bolt compl.	D931.027
	1x Sechskantschraube kpl./ vis a'six pans compl./ hex. bolt compl.	D931.026
2	1x Sattelscheibe verz./ disque a patin galv./ caliper zinc-plated	43007794
	2x Sicherungsmutter/ écrou de blocage/ lock nut	D980.007
	1x Sechskantschutzkappe / capuchonde protction Hexagonal / hex. Protective cap	45832.20
3	Halter f. Abreißeil/ support pour câble de d` attelage/ support f. breakaway cable	34006894
4	Faltenbalg/ accordeon/ bellows	69000393
5	Kabelband / câble-ruban / ribbon cable	71000194
6	Führungslager incl. Sicherungsstift / palier-guide / guide bearing	69005194
7	Gehäuse verz. / boiter compl. / housing zinc-plated	nur auf Anfrage
8	Zugstange kpl. / tirant compl./ drawbar compl. Incl. Pos. 9	202041.001
9	Anschlagring / bague de butee / stop ring	69001494
10	Stoßdämpfer/ amortisseur de chocs pur/ shock absorber	8700391314
11	Stoßdämpferhalter verz. / support d` amortisseure de chocs / shock absorber	21003593
	2x Sechskantschraube kpl./ vis a'six pans compl./ hex. bolt compl.	D933.068
12	2x Federring verz./ rondelle elastique/ spring ring	D127.008
	2x Sechskantmutter/ écrou a'six pans/ hex. nut	D934.011
	1x Federring verz./ rondelle elastique/ spring ring	D127.007
13	Handbremshebel kpl./ levier de frein a main compl./ handbrake lever compl.	202969.002
14	Handgriff / la poignee / handle	200027.001
15	Abreißeil komplett/ câble de rupture d'attelage compl./ breakaway cable compl.	203202.002
16	Federspeicher "GF" kpl. / douille a ressort compl. / spring sleeve compl.	202453.001
17	Übersetzungshebel kpl./ levier de transmission compl./ transmisson lever compl.	98722483
	1x Scheibe / rondelle / washer	45908.18
18	1x Scheibe / rondelle / washer	D125.013
	1x Scheibe / rondelle / washer	43001494
	1x Sicherungsmutter/ écrou de blocage/ lock nut	D980.004

# AUFLAUFEINRICHTUNG KRV 35-A

Ausführung "GF"

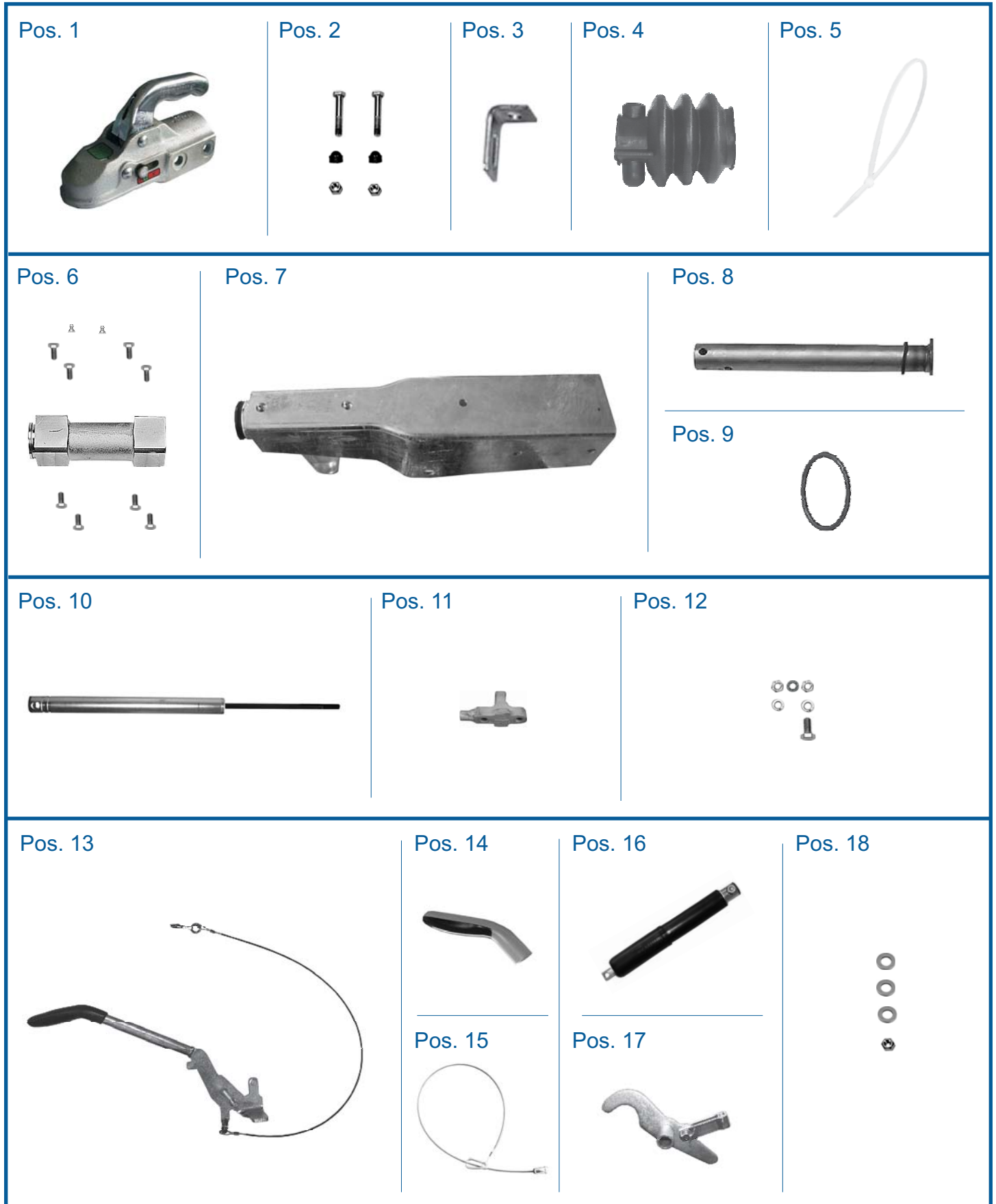



Das **Original**  
und Sie fahren mit Sicherheit weiter...

Pos	Bezeichnung	Bestell- nummer
1	Kugelumkopplung / attache a bille / ball-shaped coupling	8802559X
	2x Sechskantschraube kpl./ vis a'six pans compl./ hex. bolt compl.	D931.039
2	2x Sicherungsmutter/ écrou de blocage/ lock nut	D980.007
	2x Sechskantschutzkappe / capuchonde protction Hexagonal / hex. Protective cap	45832.20
3	Halter f. Abreißseil/ support pour câble de d` attelage/ support f. breakaway cable	34006894
4	Faltenbalg/ accordeon/ bellows	200175.001
5	Kabelband / câble-ruban / ribbon cable	71000194
	1x Führungslager / tube conducteur / glide tube	201263.001
6	8x Sicherungsschraube kpl./ vis a'six pans compl./ hex. bolt compl.	45872.16
	2x Schmiernippel / graisseur / labricating nipple	202164.001
7	Gehäuse verz. / boiter compl. / housing zinc-plated	nur auf Anfrage
8	Zugstange kpl. / tirant compl./ drawbar compl. Incl. Pos. 9	203146.001
9	Anschlagring / bague de butee / stop ring	69004394
10	Stoßdämpfer/ amortisseur de chocs pur/ shock absorber	87003613
11	Stoßdämpferhalter verz. / support d` amortisseure de chocs / shock absorber	203719.001
	2x Sechskantschraube kpl./ vis a'six pans compl./ hex. bolt compl.	D933.068
12	2x Federring verz./ rondelle elastique/ spring ring	D127.008
	2x Sechskantmutter/ écrou a'six pans/ hex. nut	D934.011
	1x Federring verz./ rondelle elastique/ spring ring	D127.007
13	Handbremshebel kpl./ levier de frein a main compl./ handbrake lever compl.	204149.001
14	Handgriff / la poignée / handle	200027.001
15	Abreißseil komplett/ câble de rupture d'attelage compl./ breakaway cable compl.	203202.001
16	Federspeicher "GF" kpl. / douille a ressort compl. / spring sleeve compl.	202453.001
17	Übersetzungshebel kpl./ levier de transmission compl./ transmisson lever compl.	98812993
	1x Scheibe / rondelle / washer	45908.18
18	1x Scheibe / rondelle / washer	D125.013
	1x Scheibe / rondelle / washer	203172.001
	1x Sicherungsmutter/ écrou de blocage/ lock nut	D980.004

# AUFLAUFEINRICHTUNG KR 7,5-C

Ausführung "KH"

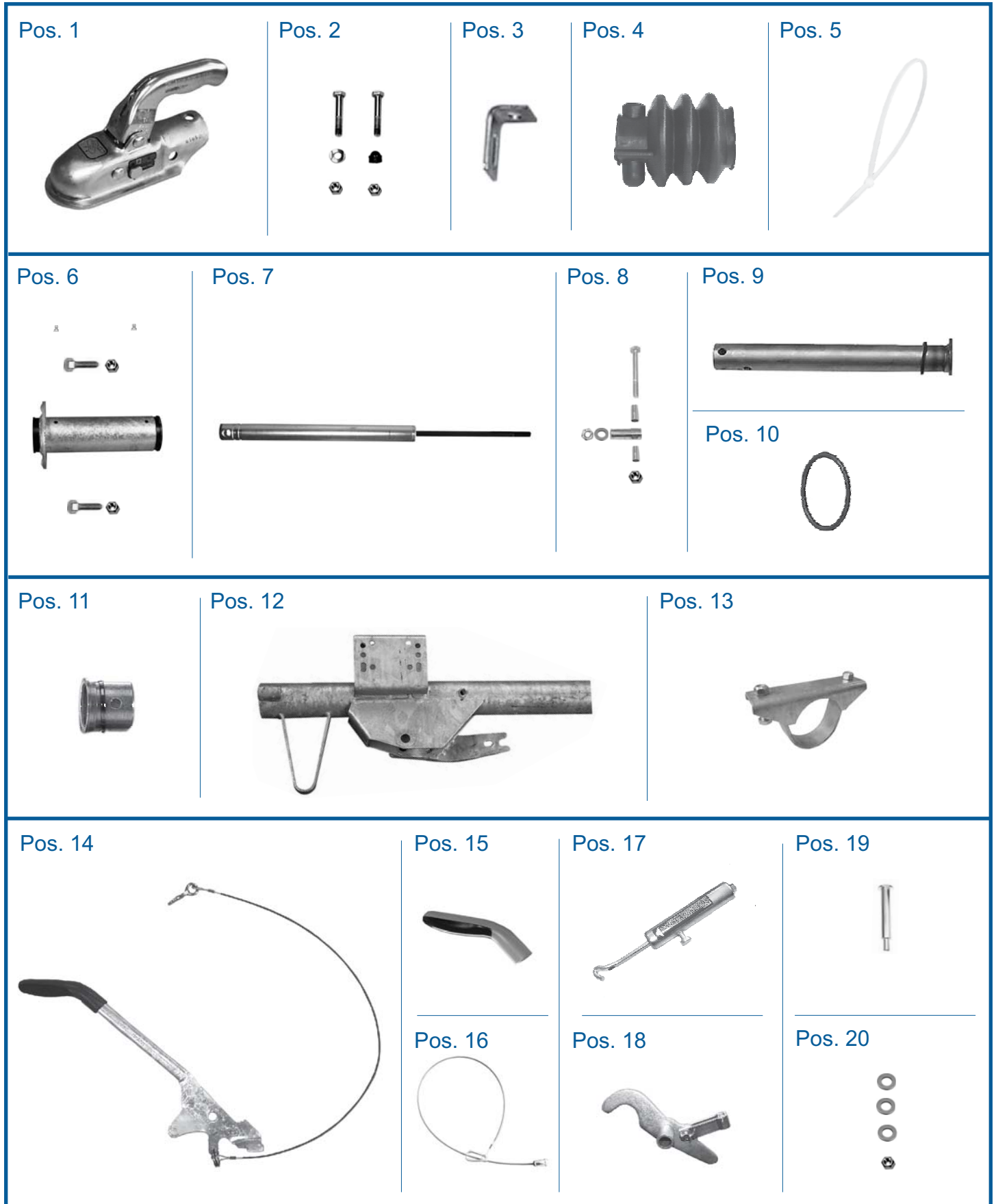

Das **Original**  
und Sie fahren mit Sicherheit weiter...

Pos	Bezeichnung	Bestell- nummer
1	Kugelumkupplung / attache a bille / ball-shaped coupling	8802429X
2	2x Sechskantschraube kpl./ vis a'six pans compl./ hex. bolt compl.	D931.017
	1x Sattelscheibe 13 verz./ disque a patin 13 galv./ caliper 13 zinc-plated	43004294
	2x Sicherungsmutter/ écrou de blocage/ lock nut	D980.004
	1x Sechskantschutzkappe / capuchonde protction Hexagonal / hex. Protective cap	45832.10
3	Halter f. Abreißeil/ support pour câble de d` attelage/ support f. breakaway cable	34006894
4	Faltenbalg/ accordeon/ bellows	69004692
5	Kabelband / câble-ruban / ribbon cable	71000194
6	1x Führungsrohr / tube conducteur / glide tube	98583793
	2x Sechskantschraube kpl./ vis a'six pans compl./ hex. bolt compl.	D931.016
	2x Sicherungsmutter/ écrou de blocage/ lock nut	D980.004
	2x Schmiernippel / graisseur / labricating nipple	48032094
7	Stoßdämpfer/ amortisseur de chocs pur/ shock absorber	87000313
8	1x Sechskantschraube kpl./ vis a'six pans compl./ hex. bolt compl.	D931.019
	2x Buchse / le coussinet / bush	36001194
	1x Kreuzkopf / le renverse / crosshead	45000194
	1x Sechskantmutter/ écrou a'six pans/ hex. Nut	D934.011
	1x Federring verz./ rondelle elastique/ spring ring	D127.007
	2x Sicherungsmutter/ écrou de blocage/ lock nut	D980.004
9	Zugstange kpl. / tirant compl./ drawbar compl. Incl. Pos. 9	98609494
10	Anschlagring / bague de butee / stop ring	69001494
11	Führungslager incl. Sicherungstift / palier-guide / guide bearing	69005094
12	Zugdeichsel geschw. / tuyau d`actionnement / traction tube	nur auf Anfrage
13	Auflagebock kpl. / support compl. / trestle compl.	98885693
14	Handbremshebel kpl./ levier de frein a main compl./ handbrake lever compl.	98703193
15	Handgriff / la poignee / handle	200027.001
16	Abreißeil komplett/ câble de rupture d'attelage compl./ breakaway cable compl.	203202.002
17	Federhülse kpl. / douille a ressort compl. / spring sleeve compl.	98702594
18	Übersetzungshebel kpl./ levier de transmission compl./ transmisson lever compl.	98722483
19	Bolzen mit Gewindezapfen/ boulon avec goupille file/ bolt with threaded pin	41004494
20	1x Scheibe A19 DIN125 PA / rondelle / washer	45908.18
	1x Scheibe A13 / rondelle / washer	43001494
	1x Scheibe A13 / rondelle / washer	D125.013
	1x Sicherungsmutter/ écrou de blocage/ lock nut	D980.004

# AUFLAUFEINRICHTUNG KR 13/7-C4

Ausführung "KH"

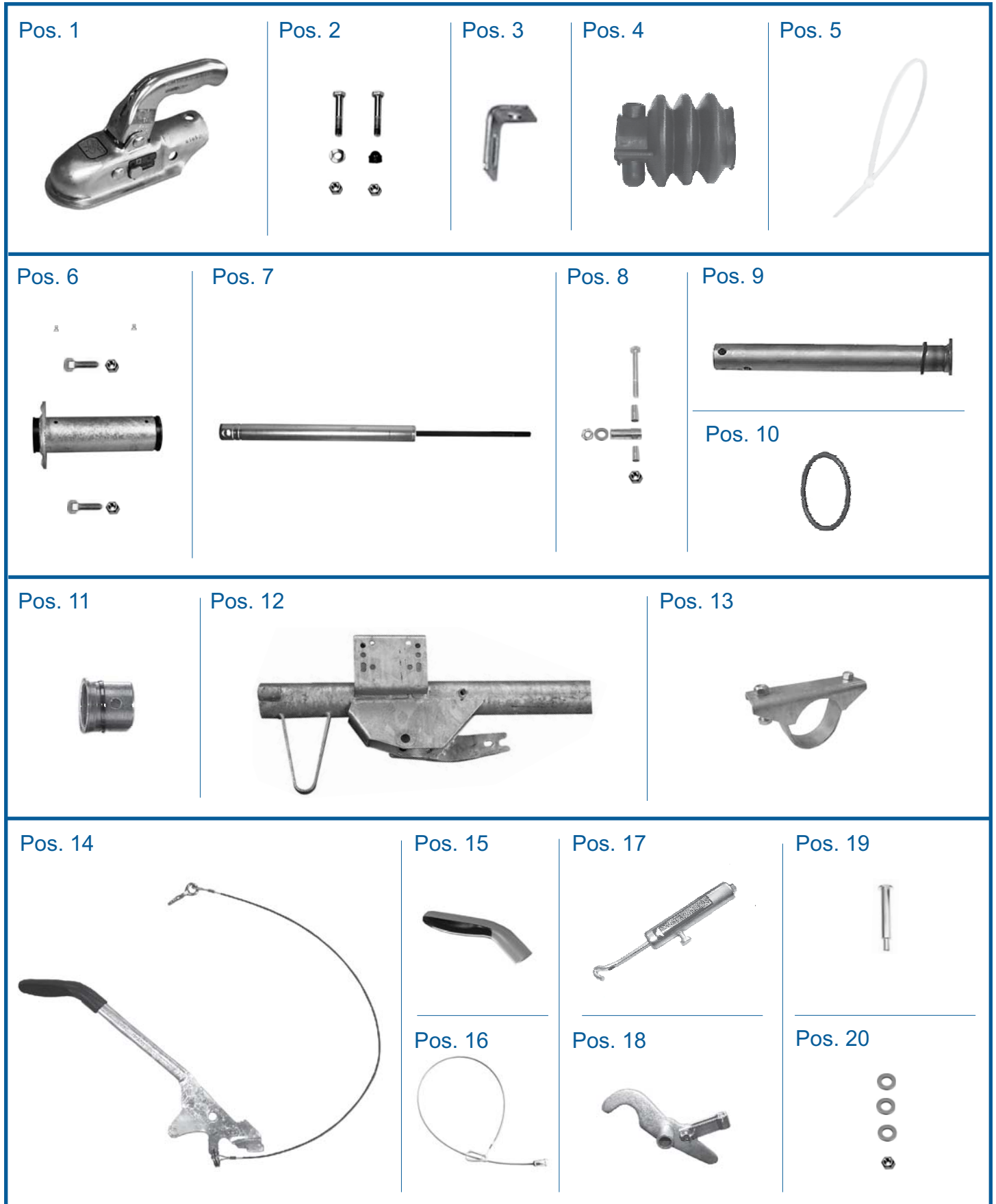

Das **Original**  
und Sie fahren mit Sicherheit weiter...

Pos	Bezeichnung	Bestell- nummer
1	Kugelumkupplung / attache a bille / ball-shaped coupling	8802429X
2	2x Sechskantschraube kpl./ vis a'six pans compl./ hex. bolt compl.	D931.017
	1x Sattelscheibe 13 verz./ disque a patin 13 galv./ caliper 13 zinc-plated	43004294
	2x Sicherungsmutter/ écrou de blocage/ lock nut	D980.004
	1x Sechskantschutzkappe / capuchonde protction Hexagonal / hex. Protective cap	45832.10
3	Halter f. Abreißeil/ support pour câble de d` attelage/ support f. breakaway cable	34006894
4	Faltenbalg/ accordeon/ bellows	69004692
5	Kabelband / câble-ruban / ribbon cable	71000194
6	1x Führungsrohr / tube conducteur / glide tube	98583793
	2x Sechskantschraube kpl./ vis a'six pans compl./ hex. bolt compl.	D931.016
	2x Sicherungsmutter/ écrou de blocage/ lock nut	D980.004
	2x Schmiernippel / graisseur / labricating nipple	48032094
7	Stoßdämpfer/ amortisseur de chocs pur/ shock absorber	87000713
8	1x Sechskantschraube kpl./ vis a'six pans compl./ hex. bolt compl.	D931.019
	2x Buchse / le coussinet / bush	36001194
	1x Kreuzkopf / le renverse / crosshead	45000194
	1x Sechskantmutter/ écrou a'six pans/ hex. Nut	D934.011
	1x Federring verz./ rondelle elastique/ spring ring	D127.007
	2x Sicherungsmutter/ écrou de blocage/ lock nut	D980.004
9	Zugstange kpl. / tirant compl./ drawbar compl. Incl. Pos. 9	98609494
10	Anschlagring / bague de butee / stop ring	69001494
11	Führungslager incl. Sicherungstift / palier-guide / guide bearing	69005094
12	Zugdeichsel geschw. / tuyau d`actionnement / traction tube	nur auf Anfrage
13	Auflagebock kpl. / support compl. / trestle compl.	98885693
14	Handbremshebel kpl./ levier de frein a main compl./ handbrake lever compl.	98703193
15	Handgriff / la poignee / handle	200027.001
16	Abreißeil komplett/ câble de rupture d'attelage compl./ breakaway cable compl.	203202.002
17	Federhülse kpl. / douille a ressort compl. / spring sleeve compl.	98702594
18	Übersetzungshebel kpl./ levier de transmission compl./ transmisson lever compl.	98722483
19	Bolzen mit Gewindezapfen/ boulon avec goupille filet/ bolt with threaded pin	41004494
20	1x Scheibe A19 DIN125 PA / rondelle / washer	45908.18
	1x Scheibe A13 / rondelle / washer	43001494
	1x Scheibe A13 / rondelle / washer	D125.013
	1x Sicherungsmutter/ écrou de blocage/ lock nut	D980.004

# AUFLAUFEINRICHTUNG KV 13-C2

Ausführung "KH"

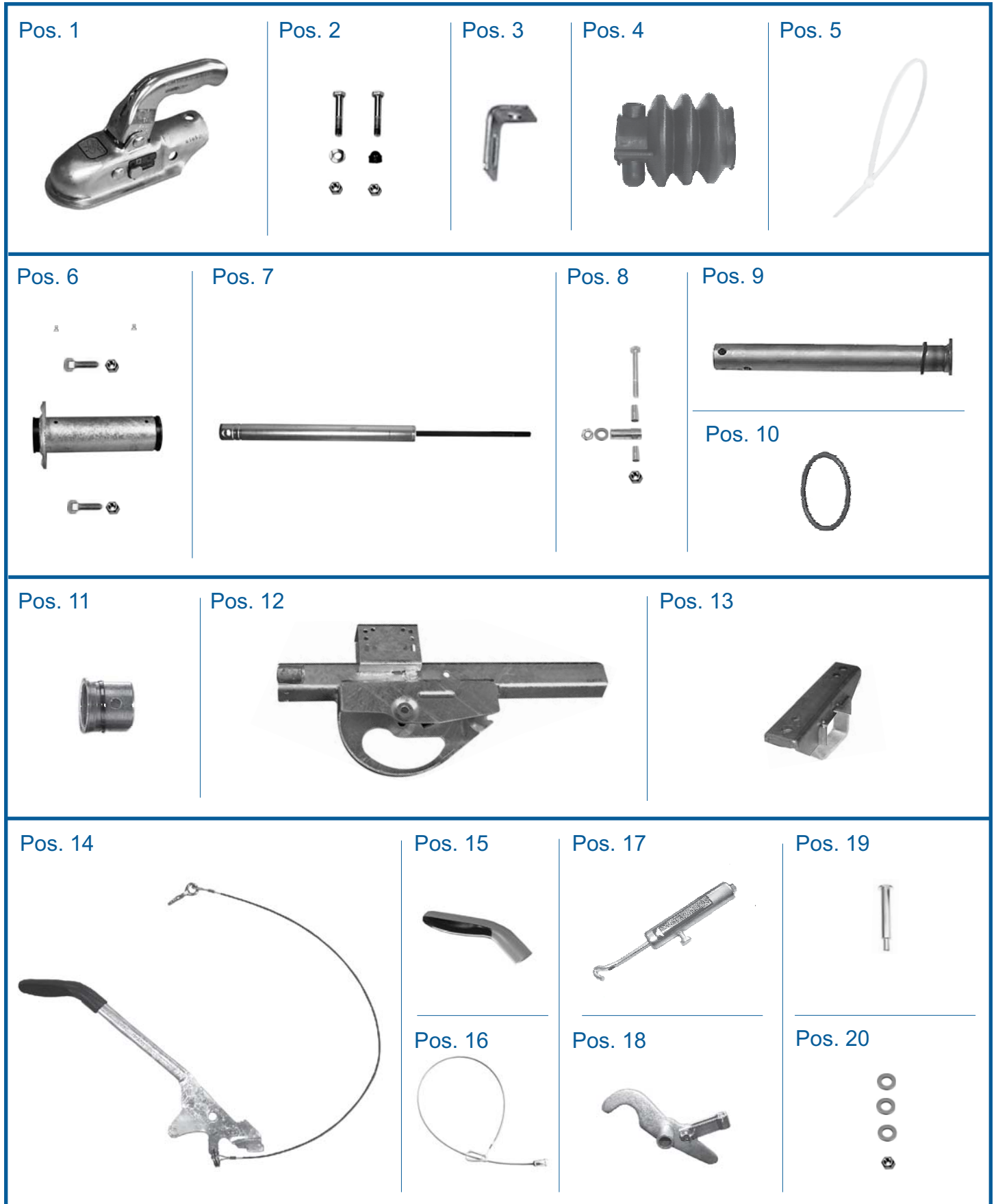











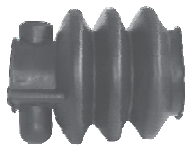







Das **Original**  
und Sie fahren mit Sicherheit weiter...

Pos	Bezeichnung	Bestell- nummer
1	Kugelkupplung / attache a bille / ball-shaped coupling	8802429X
2	2x Sechskantschraube kpl./ vis a'six pans compl./ hex. bolt compl.	D931.017
	1x Sattelscheibe 13 verz./ disque a patin 13 galv./ caliper 13 zinc-plated	43004294
	2x Sicherungsmutter/ écrou de blocage/ lock nut	D980.004
	1x Sechskantschutzkappe / capuchonde protction Hexagonal / hex. Protective cap	45832.10
3	Halter f. Abreißeil/ support pour câble de d` attelage/ support f. breakaway cable	34006894
4	Faltenbalg/ accordeon/ bellows	69004692
5	Kabelband / câble-ruban / ribbon cable	71000194
6	1x Führungsrohr / tube conducteur / glide tube	98809593
	2x Sechskantschraube kpl./ vis a'six pans compl./ hex. bolt compl.	D931.016
	2x Sicherungsmutter/ écrou de blocage/ lock nut	D980.004
	2x Schmiernippel / graisseur / labricating nipple	D71412.001
7	Stoßdämpfer/ amortisseur de chocs pur/ shock absorber	87000713
8	1x Sechskantschraube kpl./ vis a'six pans compl./ hex. bolt compl.	D931.019
	2x Buchse / le coussinet / bush	36001194
	1x Kreuzkopf / le renverse / crosshead	45000194
	1x Sechskantmutter/ écrou a'six pans/ hex. Nut	D934.011
	1x Federring verz./ rondelle elastique/ spring ring	D127.007
	1x Sicherungsmutter/ écrou de blocage/ lock nut	D980.004
9	Zugstange kpl. / tirant compl./ drawbar compl. Incl. Pos. 9	98103094
10	Anschlagring / bague de butee / stop ring	69001494
11	Führungslager incl. Sicherungsstift / palier-guide / guide bearing	69005094
12	Zugdeichsel geschw. / tuyau d`actionnement / traction tube	nur auf Anfrage
13	Auflagebock kpl. / support compl. / trestle compl.	98884993
14	Handbremshebel kpl./ levier de frein a main compl./ handbrake lever compl.	98703193
15	Handgriff / la poignee / handle	200027.001
16	Abreißeil komplett/ câble de rupture d'attelage compl./ breakaway cable compl.	203202.002
17	Federhülse kpl. / douille a ressort compl. / spring sleeve compl.	98702594
18	Übersetzungshebel kpl./ levier de transmission compl./ transmisson lever compl.	98722483
19	Bolzen mit Gewindezapfen/ boulon avec goupille filet/ bolt with threaded pin	41004494
20	2x Scheibe A19 DIN125 PA / rondelle / washer	45908.18
	1x Scheibe A13 / rondelle / washer	43001494
	1x Scheibe A13 / rondelle / washer	43000794
	1x Sicherungsmutter/ écrou de blocage/ lock nut	D980.004

# AUFLAUFEINRICHTUNG KV 13-C2

Ausführung "GF"

<p>Pos. 1</p> 	<p>Pos. 2</p> 	<p>Pos. 3</p> 	<p>Pos. 4</p> 	<p>Pos. 5</p> 
<p>Pos. 6</p> 	<p>Pos. 7</p> 	<p>Pos. 8</p> 	<p>Pos. 9</p>  <hr/> <p>Pos. 10</p> 	
<p>Pos. 11</p> 	<p>Pos. 12</p> 	<p>Pos. 13</p> 		
<p>Pos. 14</p> 	<p>Pos. 15</p>  <hr/> <p>Pos. 16</p> 	<p>Pos. 17</p>  <hr/> <p>Pos. 18</p> 	<p>Pos. 19</p> 	



Das **Original**  
und Sie fahren mit Sicherheit weiter...

Pos	Bezeichnung	Bestell- nummer
1	Kugelkupplung / attache a bille / ball-shaped coupling	8802429X
2	2x Sechskantschraube kpl./ vis a'six pans compl./ hex. bolt compl.	D931.017
	1x Sattelscheibe 13 verz./ disque a patin 13 galv./ caliper 13 zinc-plated	43004294
	2x Sicherungsmutter/ écrou de blocage/ lock nut	D980.004
	1x Sechskantschutzkappe / capuchonde protction Hexagonal / hex. Protective cap	45832.10
3	Halter f. Abreißeil/ support pour câble de d` attelage/ support f. breakaway cable	34006894
4	Faltenbalg/ accordeon/ bellows	69004692
5	Kabelband / câble-ruban / ribbon cable	71000194
6	1x Führungsrohr / tube conducteur / glide tube	98809593
	2x Sechskantschraube kpl./ vis a'six pans compl./ hex. bolt compl.	D931.016
	2x Sicherungsmutter/ écrou de blocage/ lock nut	D980.004
	2x Schmiernippel / graisseur / labricating nipple	D71412.001
7	Stoßdämpfer/ amortisseur de chocs pur/ shock absorber	87000713
8	1x Sechskantschraube kpl./ vis a'six pans compl./ hex. bolt compl.	D931.019
	2x Buchse / le coussinet / bush	36001194
	1x Kreuzkopf / le renverse / crosshead	45000194
	1x Sechskantmutter/ écrou a'six pans/ hex. Nut	D934.011
	1x Federring verz./ rondelle elastique/ spring ring	D127.007
	1x Sicherungsmutter/ écrou de blocage/ lock nut	D980.004
9	Zugstange kpl. / tirant compl./ drawbar compl. Incl. Pos. 9	98103094
10	Anschlagring / bague de butee / stop ring	69001494
11	Führungslager incl. Sicherungsstift / palier-guide / guide bearing	69005094
12	Zugdeichsel geschw. / tuyau d`actionnement / traction tube	nur auf Anfrage
13	Auflagebock kpl. / support compl. / trestle compl.	98884993
14	Handbremshebel kpl./ levier de frein a main compl./ handbrake lever compl.	201943.001
15	Handgriff / la poignee / handle	200027.001
16	Abreißeil komplett/ câble de rupture d'attelage compl./ breakaway cable compl.	203202.002
17	Federspeicher kpl. / douille a ressort compl. / spring sleeve compl.	201856.001
18	Übersetzungshebel kpl./ levier de transmission compl./ transmisson lever compl.	98722483
19	2x Scheibe A19 DIN125 PA / rondelle / washer	45908.18
	1x Scheibe A13 / rondelle / washer	43001494
	1x Scheibe A13 / rondelle / washer	D125.013
	1x Sicherungsmutter/ écrou de blocage/ lock nut	D980.004

# AUFLAUFEINRICHTUNG KV 13-C4

Ausführung "KH"

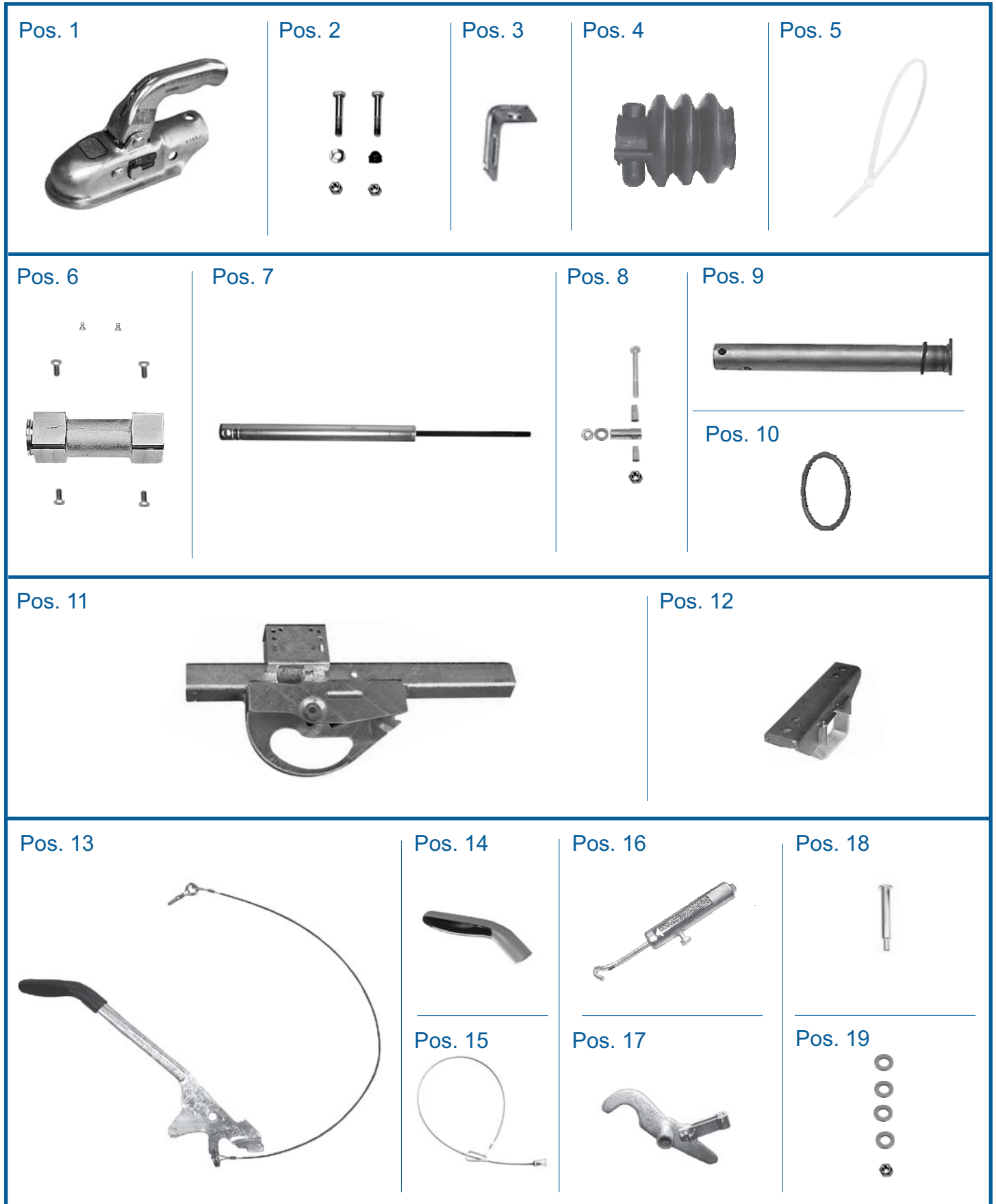

Das **Original**  
und Sie fahren mit Sicherheit weiter...

Pos	Bezeichnung	Bestell- nummer
1	Kugelumkupplung / attache a bille / ball-shaped coupling	8802429X
2	2x Sechskantschraube kpl./ vis a'six pans compl./ hex. bolt compl.	D931.017
	1x Sattelscheibe 13 verz./ disque a patin 13 galv./ caliper 13 zinc-plated	43004294
	2x Sicherungsmutter/ écrou de blocage/ lock nut	D980.004
	1x Sechskantschutzkappe / capuchonde protction Hexagonal / hex. Protective cap	45832.10
3	Halter f. Abreißeil/ support pour câble de d` attelage/ support f. breakaway cable	34006894
4	Faltenbalg/ accordeon/ bellows	69004692
5	Kabelband / câble-ruban / ribbon cable	71000194
6	1x Führungsrohr / tube conducteur / glide tube	26017893
	4x Sicherungsschraube kpl./ vis a'six pans compl./ hex. bolt compl.	45872.15
	2x Schmiernippel / graisseur / labricating nipple	48032094
7	Stoßdämpfer/ amortisseur de chocs pur/ shock absorber	87000713
8	1x Sechskantschraube kpl./ vis a'six pans compl./ hex. bolt compl.	D931.019
	2x Buchse / le coussinet / bush	36001194
	1x Kreuzkopf / le renverse / crosshead	45000194
	1x Sechskantmutter/ écrou a'six pans/ hex. Nut	D934.011
	1x Federring verz./ rondelle elastique/ spring ring	D127.007
	1x Sicherungsmutter/ écrou de blocage/ lock nut	D980.004
9	Zugstange kpl. / tirant compl./ drawbar compl. Incl. Pos. 9	98103094
10	Anschlagring / bague de butee / stop ring	69001494
11	Zugdeichsel geschw. / tuyau d`actionnement / traction tube	nur auf Anfrage
12	Auflagebock kpl. / support compl. / trestle compl.	98884993
13	Handbremshebel kpl./ levier de frein a main compl./ handbrake lever compl.	98703193
14	Handgriff / la poignée / handle	200027.001
15	Abreißeil komplett/ câble de rupture d'attelage compl./ breakaway cable compl.	203202.002
16	Federhülse kpl. / douille a ressort compl. / spring sleeve compl.	98702594
17	Übersetzungshebel kpl./ levier de transmission compl./ transmission lever compl.	98722483
18	Bolzen mit Gewindezapfen/ boulon avec goupille filet/ bolt with threaded pin	41004494
19	2x Scheibe A19 DIN125 PA / rondelle / washer	45908.18
	1x Scheibe A13 / rondelle / washer	43001494
	1x Scheibe A13 / rondelle / washer	43000794
	1x Sicherungsmutter/ écrou de blocage/ lock nut	D980.004

# AUFLAUFEINRICHTUNG KV 13-C4

Ausführung "GF"

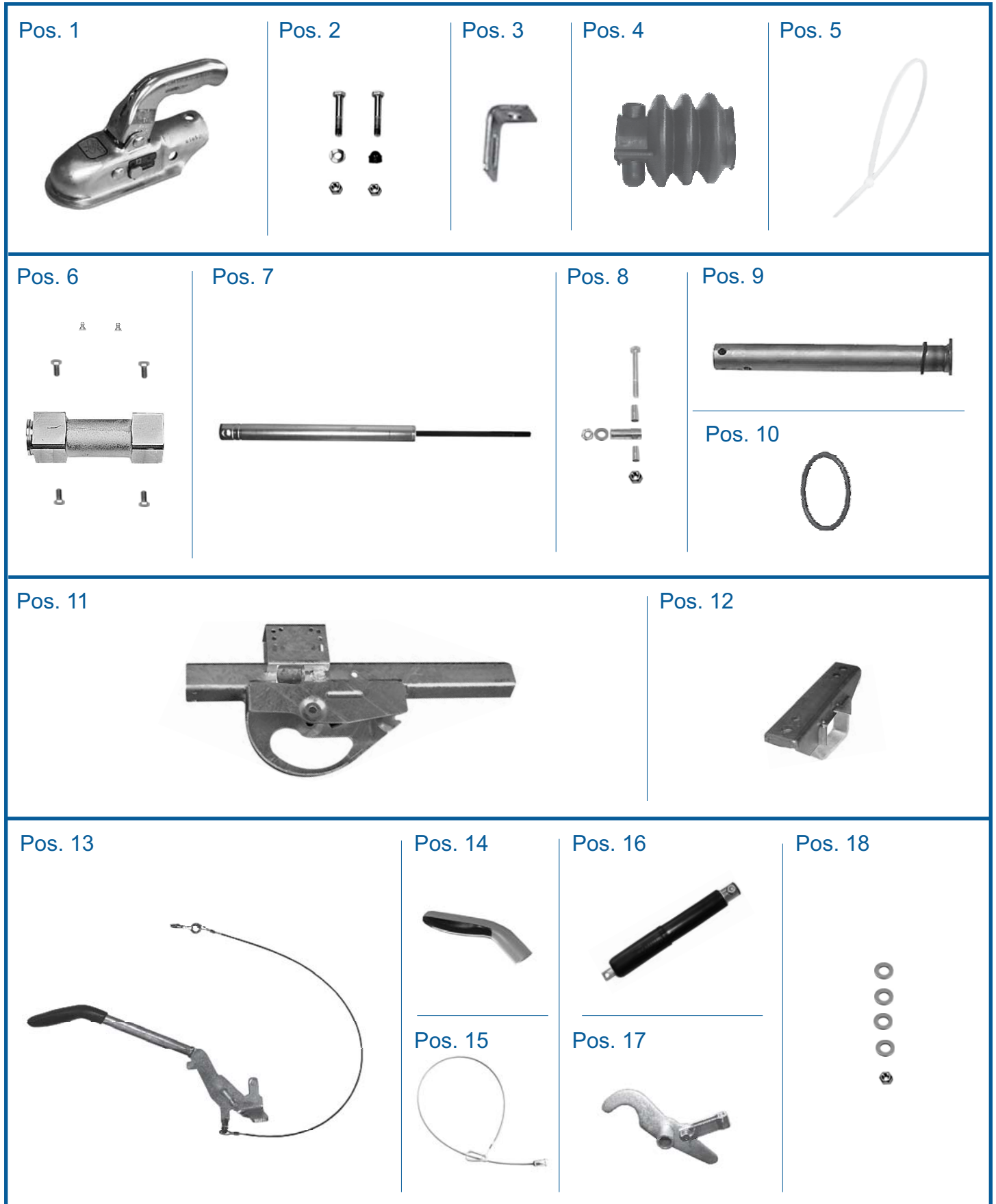

Das **Original**  
und Sie fahren mit Sicherheit weiter...

Pos	Bezeichnung	Bestell- nummer
1	Kugelkupplung / attache a bille / ball-shaped coupling	8802429X
2	2x Sechskantschraube kpl./ vis a'six pans compl./ hex. bolt compl.	D931.017
	1x Sattelscheibe 13 verz./ disque a patin 13 galv./ caliper 13 zinc-plated	43004294
	2x Sicherungsmutter/ écrou de blocage/ lock nut	D980.004
	1x Sechskantschutzkappe / capuchonde protction Hexagonal / hex. Protective cap	45832.10
3	Halter f. Abreißeil/ support pour câble de d` attelage/ support f. breakaway cable	34006894
4	Faltenbalg/ accordeon/ bellows	69004692
5	Kabelband / câble-ruban / ribbon cable	71000194
6	1x Führungsrohr / tube conducteur / glide tube	26017893
	4x Sicherungsschraube kpl./ vis a'six pans compl./ hex. bolt compl.	45872.15
	2x Schmiernippel / graisseur / labricating nipple	48032094
7	Stoßdämpfer/ amortisseur de chocs pur/ shock absorber	87000713
8	1x Sechskantschraube kpl./ vis a'six pans compl./ hex. bolt compl.	D931.019
	2x Buchse / le coussinet / bush	36001194
	1x Kreuzkopf / le renverse / crosshead	45000194
	1x Sechskantmutter/ écrou a'six pans/ hex. Nut	D934.011
	1x Federring verz./ rondelle elastique/ spring ring	D127.007
	1x Sicherungsmutter/ écrou de blocage/ lock nut	D980.004
9	Zugstange kpl. / tirant compl./ drawbar compl. Incl. Pos. 9	98103094
10	Anschlagring / bague de butee / stop ring	69001494
11	Zugdeichsel geschw. / tuyau d` actionnement / traction tube	nur auf Anfrage
12	Auflagebock kpl. / support compl. / trestle compl.	98884993
13	Handbremshebel kpl./ levier de frein a main compl./ handbrake lever compl.	201943.001
14	Handgriff / la poignee / handle	200027.001
15	Abreißeil komplett/ câble de rupture d'attelage compl./ breakaway cable compl.	203202.002
16	Federspeicher kpl. / douille a ressort compl. / spring sleeve compl.	201856.001
17	Übersetzungshebel kpl./ levier de transmission compl./ transmisson lever compl.	98722483
18	2x Scheibe A19 DIN125 PA / rondelle / washer	45908.18
	1x Scheibe A13 / rondelle / washer	43001494
	1x Scheibe A13 / rondelle / washer	D125.013
	1x Sicherungsmutter/ écrou de blocage/ lock nut	D980.004

# AUFLAUFEINRICHTUNG KR 13/82-C

Ausführung "KH"

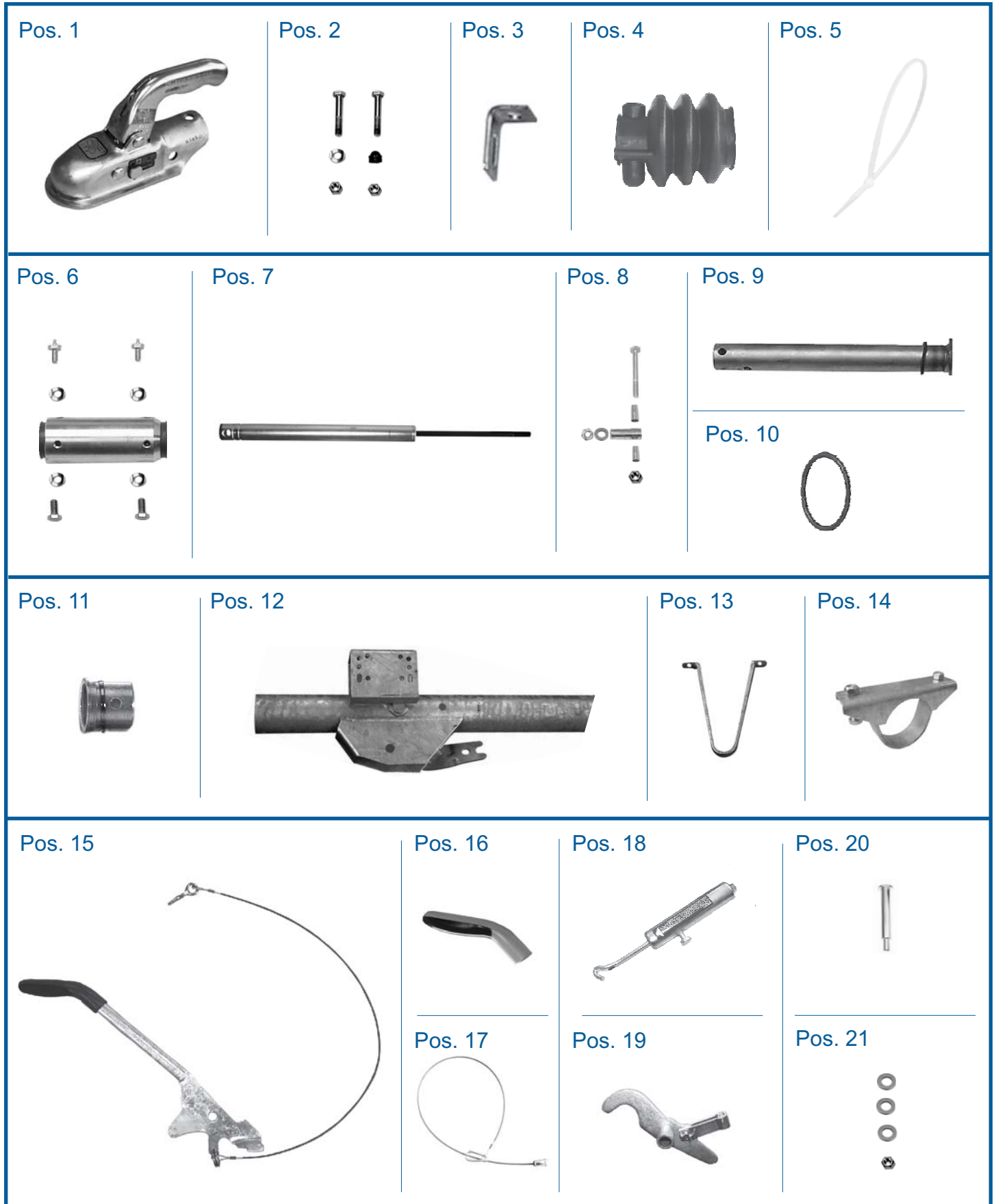

Das **Original**  
und Sie fahren mit Sicherheit weiter...

Pos	Bezeichnung	Bestell- nummer
1	Kugelumkopplung / attache a bille / ball-shaped coupling	8802429X
2	2x Sechskantschraube kpl./ vis a'six pans compl./ hex. bolt compl.	D931.017
	1x Sattelscheibe 13 verz./ disque a patin 13 galv./ caliper 13 zinc-plated	43004294
	2x Sicherungsmutter/ écrou de blocage/ lock nut	D980.004
	1x Sechskantschutzkappe / capuchonde protction Hexagonal / hex. Protective cap	45832.10
3	Halter f. Abreißseil/ support pour câble de d` attelage/ support f. breakaway cable	34006894
4	Faltenbalg/ accordeon/ bellows	69004692
5	Kabelband / câble-ruban / ribbon cable	71000194
6	1x Führungsrohr / tube conducteur / glide tube	98508393
	2x Sechskantschraube kpl./ vis a'six pans compl./ hex. bolt compl.	7100599404
	2x Sechskantschraube kpl./ vis a'six pans compl./ hex. bolt compl.	D933.070
	4x Sattelscheibe 13 verz./ disque a patin 13 galv./ caliper 13 zinc-plated	43004294
7	Stoßdämpfer/ amortisseur de chocs pur/ shock absorber	87000713
8	1x Sechskantschraube kpl./ vis a'six pans compl./ hex. bolt compl.	D931.020
	2x Buchse / le coussinet / bush	36001594
	1x Kreuzkopf / le renverse / crosshead	45000194
	1x Sechskantmutter/ écrou a'six pans/ hex. Nut	D934.011
	1x Federring verz./ rondelle elastique/ spring ring	D127.007
	1x Sicherungsmutter/ écrou de blocage/ lock nut	D980.004
9	Zugstange kpl. / tirant compl./ drawbar compl. Incl. Pos. 9	98103094
10	Anschlagring / bague de butee / stop ring	69001494
11	Führungslager incl. Sicherungsstift / palier-guide / guide bearing	69005094
12	Zugdeichsel geschw. / tuyau d`actionnement / traction tube	nur auf Anfrage
13	Stützfuß / bequille / sustainer	34083893
14	Auflagebock kpl. / support compl. / trestle compl.	98903193
15	Handbremshebel kpl./ levier de frein a main compl./ handbrake lever compl.	98703193
16	Handgriff / la poignée / handle	200027.001
17	Abreißseil komplett/ câble de rupture d'attelage compl./ breakaway cable compl.	203202.002
18	Federhülse kpl. / douille a ressort compl. / spring sleeve compl.	98702594
19	Übersetzungshebel kpl./ levier de transmission compl./ transmission lever compl.	98722483
20	Bolzen mit Gewindezapfen/ boulon avec goupille filet/ bolt with threaded pin	41004494
21	1x Scheibe A19 DIN125 PA / rondelle / washer	45908.18
	1x Scheibe A13 / rondelle / washer	43001494
	1x Scheibe A13 / rondelle / washer	D125.013
	1x Sicherungsmutter/ écrou de blocage/ lock nut	D980.004

# AUFLAUFEINRICHTUNG KR 13/82-C

Ausführung "GF"

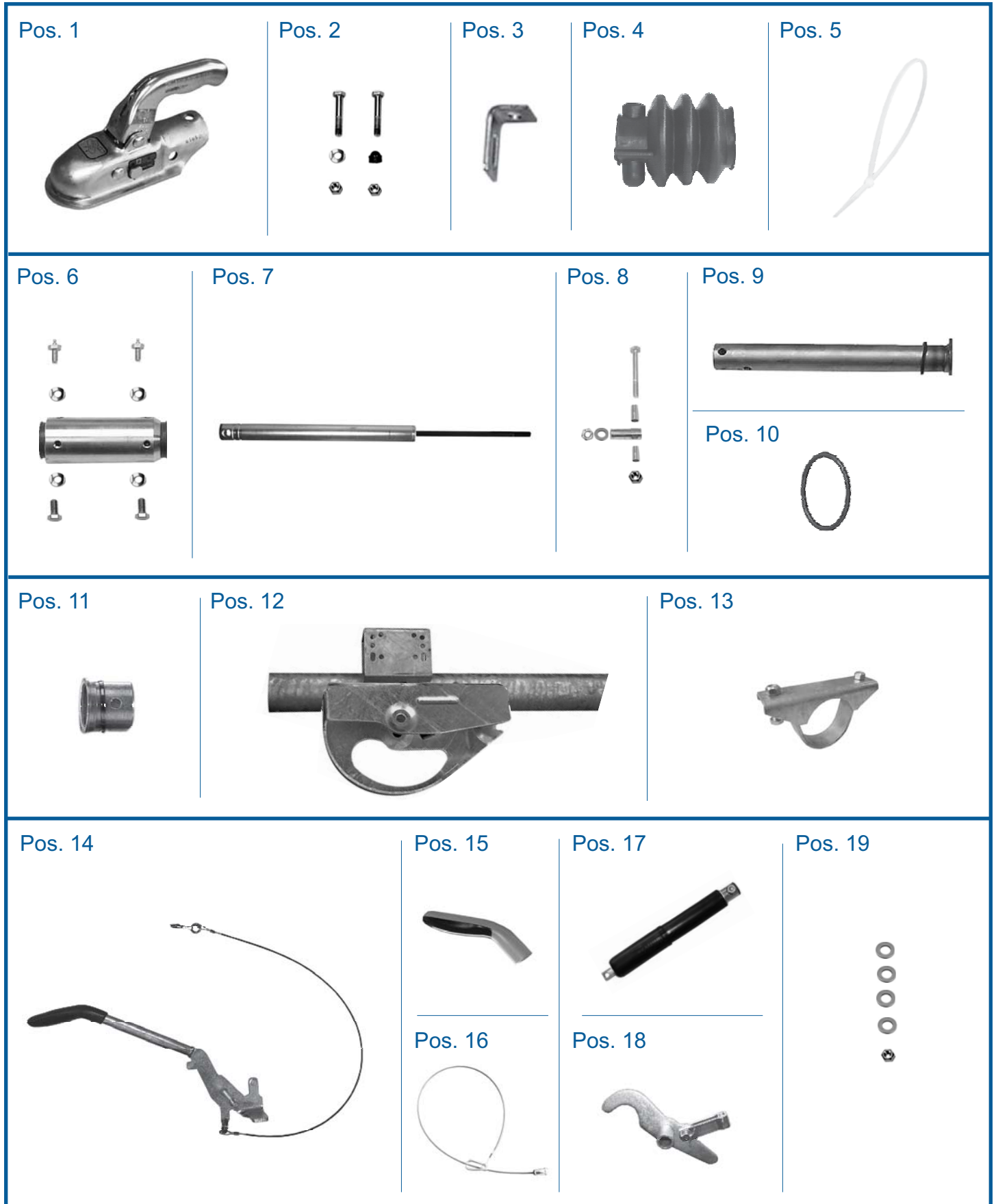



Das **Original**  
und Sie fahren mit Sicherheit weiter...

Pos	Bezeichnung	Bestell- nummer
1	Kugelkupplung / attache a bille / ball-shaped coupling	8802429X
2	2x Sechskantschraube kpl./ vis a'six pans compl./ hex. bolt compl.	D931.017
	1x Sattelscheibe 13 verz./ disque a patin 13 galv./ caliper 13 zinc-plated	43004294
	2x Sicherungsmutter/ écrou de blocage/ lock nut	D980.004
	1x Sechskantschutzkappe / capuchonde protction Hexagonal / hex. Protective cap	45832.10
3	Halter f. Abreißeil/ support pour câble de d` attelage/ support f. breakaway cable	34006894
4	Faltenbalg/ accordeon/ bellows	69004692
5	Kabelband / câble-ruban / ribbon cable	71000194
6	1x Führungsrohr / tube conducteur / glide tube	98508393
	2x Sechskantschraube kpl./ vis a'six pans compl./ hex. bolt compl.	7100599404
	2x Sechskantschraube kpl./ vis a'six pans compl./ hex. bolt compl.	D933.070
	4x Sattelscheibe 13 verz./ disque a patin 13 galv./ caliper 13 zinc-plated	43004294
7	Stoßdämpfer/ amortisseur de chocs pur/ shock absorber	87000713
8	1x Sechskantschraube kpl./ vis a'six pans compl./ hex. bolt compl.	D931.020
	2x Buchse / le coussinet / bush	36001594
	1x Kreuzkopf / le renverse / crosshead	45000194
	1x Sechskantmutter/ écrou a'six pans/ hex. Nut	D934.011
	1x Federring verz./ rondelle elastique/ spring ring	D127.007
	1x Sicherungsmutter/ écrou de blocage/ lock nut	D980.004
9	Zugstange kpl. / tirant compl./ drawbar compl. Incl. Pos. 9	98103094
10	Anschlagring / bague de butee / stop ring	69001494
11	Führungslager incl. Sicherungsstift / palier-guide / guide bearing	69005094
12	Zugdeichsel geschw. / tuyau d`actionnement / traction tube	nur auf Anfrage
13	Auflagebock kpl. / support compl. / trestle compl.	98903193
14	Handbremshebel kpl./ levier de frein a main compl./ handbrake lever compl.	201943.001
15	Handgriff / la poignee / handle	200027.001
16	Abreißeil komplett/ câble de rupture d'attelage compl./ breakaway cable compl.	203202.002
17	Federspeicher kpl. / douille a ressort compl. / spring sleeve compl.	201856.001
18	Übersetzungshebel kpl./ levier de transmission compl./ transmisson lever compl.	98722483
19	2x Scheibe A19 DIN125 PA / rondelle / washer	45908.18
	1x Scheibe A13 / rondelle / washer	43001494
	1x Scheibe A13 / rondelle / washer	D125.013
	1x Sicherungsmutter/ écrou de blocage/ lock nut	D980.004

# AUFLAUFEINRICHTUNG KV 18-C

## Ausführung "KH"

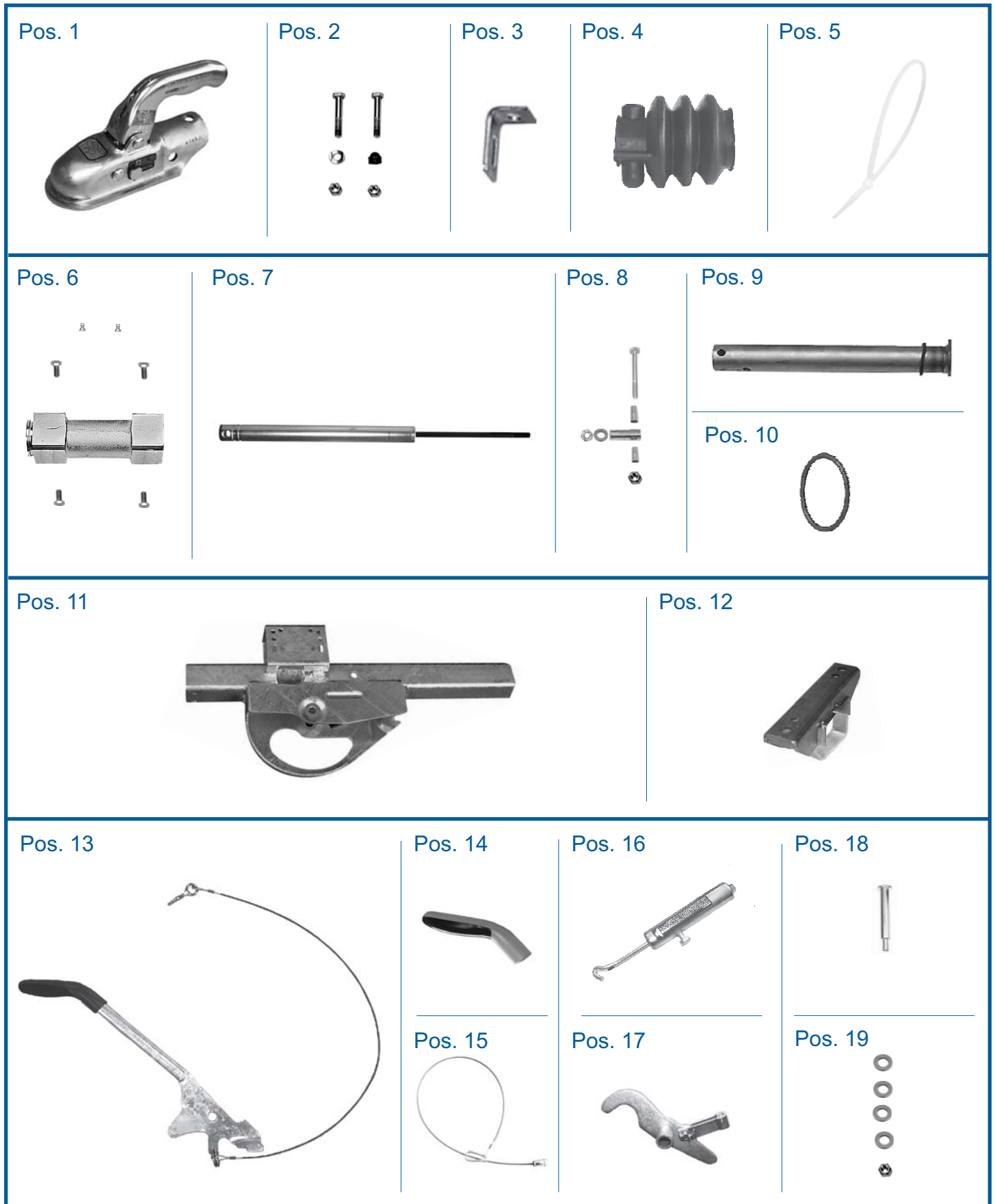











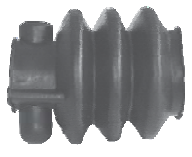



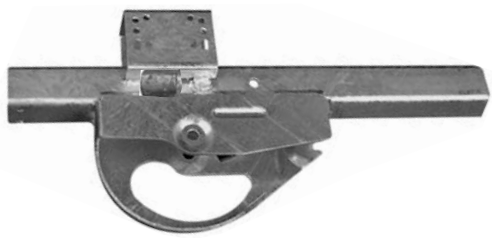

Das **Original**  
und Sie fahren mit Sicherheit weiter...

Pos	Bezeichnung	Bestell- nummer
1	Kugelkupplung / attache a bille / ball-shaped coupling	8802399X
2	2x Sechskantschraube kpl./ vis a'six pans compl./ hex. bolt compl.	D931.017
	1x Sattelscheibe 13 verz./ disque a patin 13 galv./ caliper 13 zinc-plated	43004294
	2x Sicherungsmutter/ écrou de blocage/ lock nut	D980.004
	1x Sechskantschutzkappe / capuchonde protction Hexagonal / hex. Protective cap	45832.10
3	Halter f. Abreißeil/ support pour câble de d` attelage/ support f. breakaway cable	34006894
4	Faltenbalg/ accordeon/ bellows	69004692
5	Kabelband / câble-ruban / ribbon cable	71000194
6	1x Führungsrohr / tube conducteur / glide tube	26017893
	4x Sicherungsschraube kpl./ vis a'six pans compl./ hex. bolt compl.	45872.15
	2x Schmiernippel / graisseur / labricating nipple	48032094
7	Stoßdämpfer/ amortisseur de chocs pur/ shock absorber	87001113
8	1x Sechskantschraube kpl./ vis a'six pans compl./ hex. bolt compl.	D931.019
	2x Buchse / le coussinet / bush	36001194
	1x Kreuzkopf / le renverse / crosshead	45000194
	1x Sechskantmutter/ écrou a'six pans/ hex. Nut	D934.011
	1x Federring verz./ rondelle elastique/ spring ring	D127.007
	1x Sicherungsmutter/ écrou de blocage/ lock nut	D980.004
9	Zugstange kpl. / tirant compl./ drawbar compl. Incl. Pos. 9	98103094
10	Anschlagring / bague de butee / stop ring	69001494
11	Zugdeichsel geschw. / tuyau d`actionnement / traction tube	nur auf Anfrage
12	Auflagebock kpl. / support compl. / trestle compl.	98884993
13	Handbremshebel kpl./ levier de frein a main compl./ handbrake lever compl.	98703193
14	Handgriff / la poignee / handle	200027.001
15	Abreißeil komplett/ câble de rupture d'attelage compl./ breakaway cable compl.	203202.002
16	Federhülse kpl. / douille a ressort compl. / spring sleeve compl.	98702594
17	Übersetzungshebel kpl./ levier de transmission compl./ transmisson lever compl.	98722483
18	Bolzen mit Gewindezapfen/ boulon avec goupille filet/ bolt with threaded pin	41004494
19	2x Scheibe A19 DIN125 PA / rondelle / washer	45908.18
	1x Scheibe A13 / rondelle / washer	43001494
	1x Scheibe A13 / rondelle / washer	43000794
	1x Sicherungsmutter/ écrou de blocage/ lock nut	D980.004

# AUFLAUFEINRICHTUNG KV 18-C

Ausführung "GF"













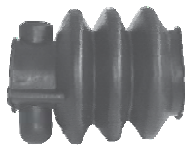





<p>Pos. 1</p> 	<p>Pos. 2</p> 	<p>Pos. 3</p> 	<p>Pos. 4</p> 	<p>Pos. 5</p> 
<p>Pos. 6</p> 	<p>Pos. 7</p> 	<p>Pos. 8</p> 	<p>Pos. 9</p>  <hr/> <p>Pos. 10</p> 	
<p>Pos. 11</p> 	<p>Pos. 12</p> 			
<p>Pos. 13</p> 	<p>Pos. 14</p>  <hr/> <p>Pos. 15</p> 	<p>Pos. 16</p>  <hr/> <p>Pos. 17</p> 	<p>Pos. 18</p> 	

Das **Original**  
und Sie fahren mit Sicherheit weiter...

Pos	Bezeichnung	Bestell- nummer
1	Kugelumkupplung / attache a bille / ball-shaped coupling	8802399X
2	2x Sechskantschraube kpl./ vis a'six pans compl./ hex. bolt compl.	D931.017
	1x Sattelscheibe 13 verz./ disque a patin 13 galv./ caliper 13 zinc-plated	43004294
	2x Sicherungsmutter/ écrou de blocage/ lock nut	D980.004
	1x Sechskantschutzkappe / capuchonde protction Hexagonal / hex. Protective cap	45832.10
3	Halter f. Abreißseil/ support pour câble de d` attelage/ support f. breakaway cable	34006894
4	Faltenbalg/ accordeon/ bellows	69004692
5	Kabelband / câble-ruban / ribbon cable	71000194
6	1x Führungsrohr / tube conducteur / glide tube	26017893
	4x Sicherungsschraube kpl./ vis a'six pans compl./ hex. bolt compl.	45872.15
	2x Schmiernippel / graisseur / labricating nipple	48032094
7	Stoßdämpfer/ amortisseur de chocs pur/ shock absorber	87001113
8	1x Sechskantschraube kpl./ vis a'six pans compl./ hex. bolt compl.	D931.019
	2x Buchse / le coussinet / bush	36001194
	1x Kreuzkopf / le renverse / crosshead	45000194
	1x Sechskantmutter/ écrou a'six pans/ hex. Nut	D934.011
	1x Federring verz./ rondelle elastique/ spring ring	D127.007
	1x Sicherungsmutter/ écrou de blocage/ lock nut	D980.004
9	Zugstange kpl. / tirant compl./ drawbar compl. Incl. Pos. 9	98103094
10	Anschlagring / bague de butee / stop ring	69001494
11	Zugdeichsel geschw. / tuyau d` actionnement / traction tube	nur auf Anfrage
12	Auflagebock kpl. / support compl. / trestle compl.	98884993
13	Handbremshebel kpl./ levier de frein a main compl./ handbrake lever compl.	201943.001
14	Handgriff / la poignee / handle	200027.001
15	Abreißseil komplett/ câble de rupture d'attelage compl./ breakaway cable compl.	203202.002
16	Federspeicher kpl. / douille a ressort compl. / spring sleeve compl.	201856.001
17	Übersetzungshebel kpl./ levier de transmission compl./ transmisson lever compl.	98722483
18	2x Scheibe A19 DIN125 PA / rondelle / washer	45908.18
	1x Scheibe A13 / rondelle / washer	43001494
	1x Scheibe A13 / rondelle / washer	D125.013
	1x Sicherungsmutter/ écrou de blocage/ lock nut	D980.004

# AUFLAUFEINRICHTUNG KR 20-A

Ausführung "KH"













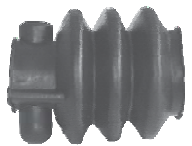



<p>Pos. 1</p> 	<p>Pos. 2</p> 	<p>Pos. 3</p> 	<p>Pos. 4</p> 	<p>Pos. 5</p> 
<p>Pos. 6</p> 	<p>Pos. 7</p> 	<p>Pos. 8</p> 	<p>Pos. 9</p>  <hr/> <p>Pos. 10</p> 	
<p>Pos. 11</p> 	<p>Pos. 12</p> 	<p>Pos. 13</p> 		
<p>Pos. 14</p> 	<p>Pos. 15</p> 	<p>Pos. 17</p> 	<p>Pos. 19</p> 	
<p>Pos. 16</p> 	<p>Pos. 18</p> 	<p>Pos. 20</p> 		

Das **Original**  
und Sie fahren mit Sicherheit weiter...

Pos	Bezeichnung	Bestell- nummer
1	Kugelumkupplung / attache a bille / ball-shaped coupling	8802399X
2	2x Sechskantschraube kpl./ vis a'six pans compl./ hex. bolt compl.	D931.017
	1x Sattelscheibe 13 verz./ disque a patin 13 galv./ caliper 13 zinc-plated	43004294
	2x Sicherungsmutter/ écrou de blocage/ lock nut	D980.004
	1x Sechskantschutzkappe / capuchonde protction Hexagonal / hex. Protective cap	45832.10
3	Halter f. Abreißeil/ support pour câble de d` attelage/ support f. breakaway cable	34006894
4	Faltenbalg/ accordeon/ bellows	69004692
5	Kabelband / câble-ruban / ribbon cable	71000194
6	1x Führungsrohr / tube conducteur / glide tube	201398.003
	4x Sicherungsschraube kpl./ vis a'six pans compl./ hex. bolt compl.	45872.17
	2x Schmiernippel / graisseur / labricating nipple	202164.001
	4x Sattelscheibe 13 verz./ disque a patin 13 galv./ caliper 13 zinc-plated	43004294
7	Stoßdämpfer/ amortisseur de chocs pur/ shock absorber	87000713
8	1x Sechskantschraube kpl./ vis a'six pans compl./ hex. bolt compl.	D931.021
	2x Buchse / le coussinet / bush	36015194
	1x Kreuzkopf / le renverse / crosshead	45000194
	1x Sechskantmutter/ écrou a'six pans/ hex. Nut	D934.011
	1x Federring verz./ rondelle elastique/ spring ring	D127.007
	1x Sicherungsmutter/ écrou de blocage/ lock nut	D980.004
9	Zugstange kpl. / tirant compl./ drawbar compl. Incl. Pos. 9	98103094
10	Anschlagring / bague de butee / stop ring	69001494
11	Zugdeichsel geschw. / tuyau d`actionnement / traction tube	nur auf Anfrage
12	Stützfuß / bequille / sustainer	34083893
13	Auflagebock kpl. / support compl. / trestle compl.	98885293
14	Handbremshebel kpl./ levier de frein a main compl./ handbrake lever compl.	98703193
15	Handgriff / la poignee / handle	200027.001
16	Abreißeil komplett/ câble de rupture d'attelage compl./ breakaway cable compl.	203202.002
17	Federhülse kpl. / douille a ressort compl. / spring sleeve compl.	98702594
18	Übersetzungshebel kpl./ levier de transmission compl./ transmisson lever compl.	98722483
19	Bolzen mit Gewindezapfen/ boulon avec goupille file/ bolt with threaded pin	41004494
20	2x Scheibe A19 DIN125 PA / rondelle / washer	45908.18
	1x Scheibe A13 / rondelle / washer	43000794
	1x Sicherungsmutter/ écrou de blocage/ lock nut	D980.004

# AUFLAUFEINRICHTUNG KR 20-A

Ausführung "GF"

<p>Pos. 1</p> 	<p>Pos. 2</p> 	<p>Pos. 3</p> 	<p>Pos. 4</p> 	<p>Pos. 5</p> 
<p>Pos. 6</p> 	<p>Pos. 7</p> 	<p>Pos. 8</p> 	<p>Pos. 9</p>  <hr/> <p>Pos. 10</p> 	
<p>Pos. 11</p> 	<p>Pos. 12</p> 			
<p>Pos. 13</p> 	<p>Pos. 14</p> 	<p>Pos. 16</p> 	<p>Pos. 18</p> 	
<p>Pos. 15</p> 	<p>Pos. 17</p> 			















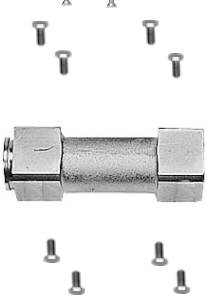

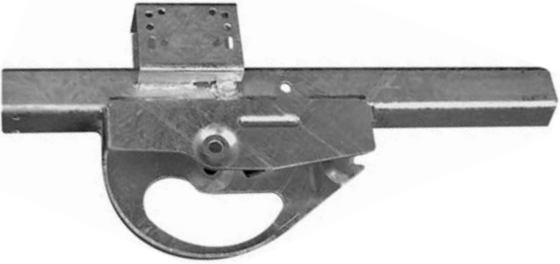

Das **Original**  
und Sie fahren mit Sicherheit weiter...

Pos	Bezeichnung	Bestell- nummer
1	Kugelkupplung / attache a bille / ball-shaped coupling	8802399X
2	2x Sechskantschraube kpl./ vis a'six pans compl./ hex. bolt compl.	D931.017
	1x Sattelscheibe 13 verz./ disque a patin 13 galv./ caliper 13 zinc-plated	43004294
	2x Sicherungsmutter/ écrou de blocage/ lock nut	D980.004
	1x Sechskantschutzkappe / capuchonde protction Hexagonal / hex. Protective cap	45832.10
3	Halter f. Abreißseil/ support pour câble de d` attelage/ support f. breakaway cable	34006894
4	Faltenbalg/ accordeon/ bellows	69004692
5	Kabelband / câble-ruban / ribbon cable	71000194
6	1x Führungsrohr / tube conducteur / glide tube	201398.003
	4x Sicherungsschraube kpl./ vis a'six pans compl./ hex. bolt compl.	45872.17
	2x Schmiernippel / graisseur / labricating nipple	202164.001
	4x Sattelscheibe 13 verz./ disque a patin 13 galv./ caliper 13 zinc-plated	43004294
7	Stoßdämpfer/ amortisseur de chocs pur/ shock absorber	87000713
8	1x Sechskantschraube kpl./ vis a'six pans compl./ hex. bolt compl.	D931.021
	2x Buchse / le coussinet / bush	36015194
	1x Kreuzkopf / le renverse / crosshead	45000194
	1x Sechskantmutter/ écrou a'six pans/ hex. Nut	D934.011
	1x Federring verz./ rondelle elastique/ spring ring	D127.007
	1x Sicherungsmutter/ écrou de blocage/ lock nut	D980.004
9	Zugstange kpl. / tirant compl./ drawbar compl. Incl. Pos. 9	98103094
10	Anschlagring / bague de butee / stop ring	69001494
11	Zugdeichsel geschw. / tuyau d`actionnement / traction tube	nur auf Anfrage
12	Auflagebock kpl. / support compl. / trestle compl.	98885293
14	Handbremshebel kpl./ levier de frein a main compl./ handbrake lever compl.	201943.001
15	Handgriff / la poignee / handle	200027.001
16	Abreißseil komplett/ câble de rupture d'attelage compl./ breakaway cable compl.	203202.002
17	Federspeicher kpl. / douille a ressort compl. / spring sleeve compl.	201856.001
18	Übersetzungshebel kpl./ levier de transmission compl./ transmisson lever compl.	98722483
19	2x Scheibe A19 DIN125 PA / rondelle / washer	45908.18
	1x Scheibe A13 / rondelle / washer	D125.013
	1x Scheibe A13 / rondelle / washer	43001494
	1x Sicherungsmutter/ écrou de blocage/ lock nut	D980.004

# AUFLAUFEINRICHTUNG KR 30-A / B

Ausführung "KH"

<p>Pos. 1</p> 	<p>Pos. 2</p> 	<p>Pos. 3</p> 	<p>Pos. 4</p> 	<p>Pos. 5</p> 
<p>Pos. 6</p> 	<p>Pos. 7</p> 	<p>Pos. 8</p> 	<p>Pos. 9</p>  <hr/> <p>Pos. 10</p> 	
<p>Pos. 11</p> 	<p>Pos. 12</p> 			
<p>Pos. 13</p> 	<p>Pos. 14</p>  <hr/> <p>Pos. 15</p> 	<p>Pos. 16</p>  <hr/> <p>Pos. 17</p> 	<p>Pos. 18</p>  <hr/> <p>Pos. 19</p> 	

Das **Original**  
und Sie fahren mit Sicherheit weiter...

Pos	Bezeichnung	Bestell- nummer
1	Kugelumkupplung / attache a bille / ball-shaped coupling	8802539X
	1x Sechskantschraube kpl./ vis a'six pans compl./ hex. bolt compl.	D931.026
	1x Sechskantschraube kpl./ vis a'six pans compl./ hex. bolt compl.	D931.027
2	1x Sattelscheibe 13 verz./ disque a patin 13 galv./ caliper 13 zinc-plated	43007794
	2x Sicherungsmutter/ écrou de blocage/ lock nut	D980.007
	1x Sechskantschutzkappe / capuchonde protction Hexagonal / hex. Protective cap	45832.20
3	Halter f. Abreißeil/ support pour câble de d` attelage/ support f. breakaway cable	34006894
4	Faltenbalg/ accordeon/ bellows	69000393
5	Kabelband / câble-ruban / ribbon cable	71000194
	1x Führungsrohr / tube conducteur / glide tube	200312.002
6	8x Sicherungsschraube kpl./ vis a'six pans compl./ hex. bolt compl.	45872.16
	2x Schmiernippel / graisseur / labricating nipple	202164.001
7	Stoßdämpfer/ amortisseur de chocs pur/ shock absorber <b>1500 - 2600kg</b>	87001313
	Stoßdämpfer/ amortisseur de chocs pur/ shock absorber <b>2500 - 3000kg</b>	87001413
	1x Sechskantschraube kpl./ vis a'six pans compl./ hex. bolt compl.	D931.021
	2x Buchse / le coussinet / bush	36015194
8	1x Kreuzkopf / le renverse / crosshead	45000194
	1x Sechskantmutter/ écrou a'six pans/ hex. Nut	D934.011
	1x Federring verz./ rondelle elastique/ spring ring	D127.007
	1x Sicherungsmutter/ écrou de blocage/ lock nut	D980.004
9	Zugstange kpl. / tirant compl./ drawbar compl. Incl. Pos. 9	98596283
10	Anschlagring / bague de butee / stop ring	69001494
11	Zugdeichsel geschw. / tuyau d`actionnement / traction tube	nur auf Anfrage
12	Auflagebock kpl. / support compl. / trestle compl.	98761193
13	Handbremshebel kpl./ levier de frein a main compl./ handbrake lever compl.	98703193
14	Handgriff / la poignee / handle	200027.001
15	Abreißeil komplett/ câble de rupture d'attelage compl./ breakaway cable compl.	203202.002
16	Federhülse kpl. / douille a ressort compl. / spring sleeve compl.	98702694
17	Übersetzungshebel kpl./ levier de transmission compl./ transmisson lever compl.	98812993
18	Bolzen mit Gewindezapfen/ boulon avec goupille file/ bolt with threaded pin	41004694
	2x Scheibe A19 DIN125 PA / rondelle / washer	45908.18
19	1x Scheibe A13 / rondelle / washer	43000794
	1x Sicherungsmutter/ écrou de blocage/ lock nut	D980.004

# AUFLAUFEINRICHTUNG KR 30-A / B

Ausführung "GF"

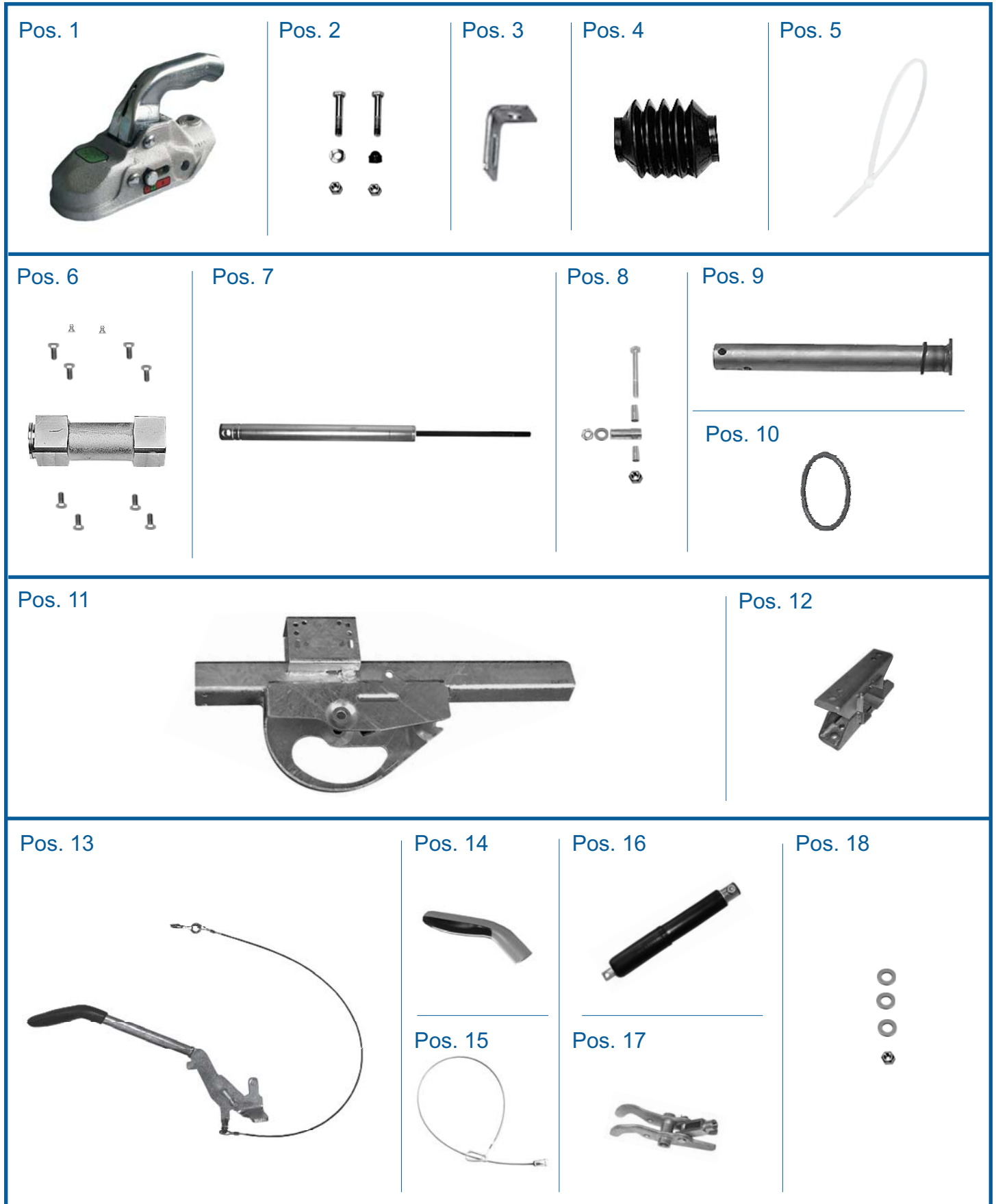











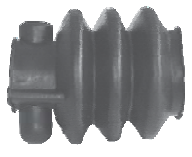

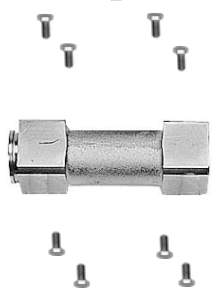

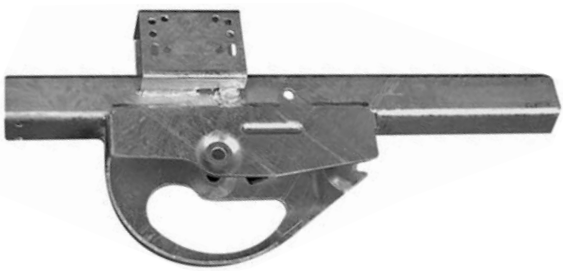

Das **Original**  
und Sie fahren mit Sicherheit weiter...

Pos	Bezeichnung	Bestell- nummer
1	Kugelpkupplung / attache a bille / ball-shaped coupling	8802539X
	1x Sechskantschraube kpl./ vis a'six pans compl./ hex. bolt compl.	D931.026
	1x Sechskantschraube kpl./ vis a'six pans compl./ hex. bolt compl.	D931.027
2	1x Sattelscheibe 13 verz./ disque a patin 13 galv./ caliper 13 zinc-plated	43007794
	2x Sicherungsmutter/ écrou de blocage/ lock nut	D980.007
	1x Sechskantschutzkappe / capuchonde protction Hexagonal / hex. Protective cap	45832.20
3	Halter f. Abreißeil/ support pour câble de d` attelage/ support f. breakaway cable	34006894
4	Faltenbalg/ accordeon/ bellows	69000393
5	Kabelband / câble-ruban / ribbon cable	71000194
	1x Führungslager / tube conducteur / glide tube	200312.002
6	8x Sicherungsschraube kpl./ vis a'six pans compl./ hex. bolt compl.	45872.16
	2x Schmiernippel / graisseur / labricating nipple	202164.001
7	Stoßdämpfer/ amortisseur de chocs pur/ shock absorber <b>1500 - 2600kg</b>	87001313
	Stoßdämpfer/ amortisseur de chocs pur/ shock absorber <b>2500 - 3000kg</b>	87001413
	1x Sechskantschraube kpl./ vis a'six pans compl./ hex. bolt compl.	D931.021
	2x Buchse / le coussinet / bush	36015194
8	1x Kreuzkopf / le renverse / crosshead	45000194
	1x Sechskantmutter/ écrou a'six pans/ hex. Nut	D934.011
	1x Federring verz./ rondelle elastique/ spring ring	D127.007
	1x Sicherungsmutter/ écrou de blocage/ lock nut	D980.004
9	Zugstange kpl. / tirant compl./ drawbar compl. Incl. Pos. 9	98596283
10	Anschlagring / bague de butee / stop ring	69001494
11	Zugdeichsel geschw. / tuyau d`actionnement / traction tube	nur auf Anfrage
12	Auflagebock kpl. / support compl. / trestle compl.	98761193
13	Handbremshebel kpl./ levier de frein a main compl./ handbrake lever compl.	202682.001
14	Handgriff / la poignee / handle	200027.001
15	Abreißeil komplett/ câble de rupture d'attelage compl./ breakaway cable compl.	203202.002
16	Federhülse kpl. / douille a ressort compl. / spring sleeve compl.	202453.001
17	Übersetzungshebel kpl./ levier de transmission compl./ transmisson lever compl.	98812993
	1x Scheibe A19 DIN125 PA / rondelle / washer	45908.18
18	1x Scheibe A13 / rondelle / washer	D125.013
	2x Scheibe A13 / rondelle / washer	43001494
	1x Sicherungsmutter/ écrou de blocage/ lock nut	D980.004

# AUFLAUFEINRICHTUNG KR 35-D

Ausführung "KH"













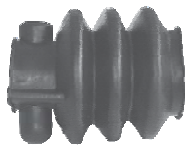

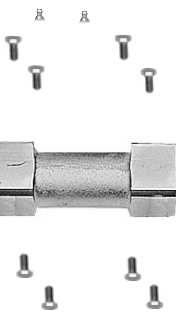

<p>Pos. 1</p> 	<p>Pos. 2</p> 	<p>Pos. 3</p> 	<p>Pos. 4</p> 	<p>Pos. 5</p> 
<p>Pos. 6</p> 	<p>Pos. 7</p> 	<p>Pos. 8</p> 	<p>Pos. 9</p>  <hr/> <p>Pos. 10</p> 	
<p>Pos. 11</p> 	<p>Pos. 12</p> 			
<p>Pos. 13</p> 	<p>Pos. 14</p>  <hr/> <p>Pos. 15</p> 	<p>Pos. 16</p>  <hr/> <p>Pos. 17</p> 	<p>Pos. 18</p>  <hr/> <p>Pos. 19</p> 	

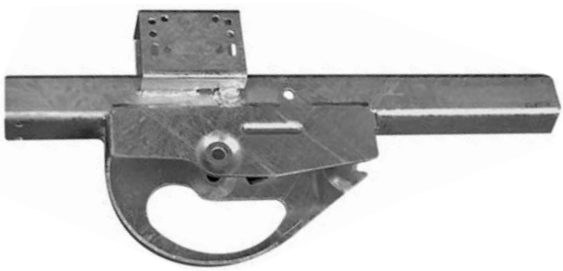
Das **Original**  
und Sie fahren mit Sicherheit weiter...

Pos	Bezeichnung	Bestell- nummer
1	Kugelumkupplung / attache a bille / ball-shaped coupling	8802559X
	2x Sechskantschraube kpl./ vis a'six pans compl./ hex. bolt compl.	D931.039
2	2x Sicherungsmutter/ écrou de blocage/ lock nut	D980.007
	1x Sechskantschutzkappe / capuchonde protction Hexagonal / hex. Protective cap	45832.20
3	Halter f. AbreiÙseil/ support pour câble de d` attelage/ support f. breakaway cable	34006894
4	Faltenbalg/ accordeon/ bellows	200175.001
5	Kabelband / câble-ruban / ribbon cable	71000194
	1x Führungslager / tube conducteur / glide tube	200452.002
6	8x Sicherungsschraube kpl./ vis a'six pans compl./ hex. bolt compl.	45872.16
	2x Schmiernippel / graisseur / labricating nipple	202164.001
7	StoÙdämpfer/ amortisseur de chocs pur/ shock absorber	87003613
	1x Sechskantschraube kpl./ vis a'six pans compl./ hex. bolt compl.	D931.036
	2x Buchse / le coussinet / bush	36018694
8	1x Kreuzkopf / le renverse / crosshead	45000194
	1x Sechskantmutter/ écrou a'six pans/ hex. Nut	D934.011
	1x Federring verz./ rondelle elastique/ spring ring	D127.007
	1x Sicherungsmutter/ écrou de blocage/ lock nut	D980.004
9	Zugstange kpl. / tirant compl./ drawbar compl. Incl.	203146.001
10	Anschlagring / bague de butee / stop ring	69004394
11	Zugdeichsel geschw. / tuyau d`actionnement / traction tube	nur auf Anfrage
12	Auflagebock kpl. / support compl. / trestle compl.	98761093
13	Handbremshebel kpl./ levier de frein a main compl./ handbrake lever compl.	98703193
14	Handgriff / la poignee / handle	200027.001
15	AbreiÙseil komplett/ câble de rupture d'attelage compl./ breakaway cable compl.	203202.002
16	Federhülse kpl. / douille a ressort compl. / spring sleeve compl.	98702694
17	Übersetzungshebel kpl./ levier de transmission compl./ transmisson lever compl.	98812993
18	Bolzen mit Gewindezapfen/ boulon avec goupille filet/ bolt with threaded pin	41006094
	3x Scheibe A19 DIN125 PA / rondelle / washer	45908.18
19	1x Scheibe A13 / rondelle / washer	43001494
	1x Scheibe A13 / rondelle / washer	43000794
	1x Sicherungsmutter/ écrou de blocage/ lock nut	D980.004

# AUFLAUFEINRICHTUNG KR 35-D

Ausführung "GF"

<p>Pos. 1</p> 	<p>Pos. 2</p> 	<p>Pos. 3</p> 	<p>Pos. 4</p> 	<p>Pos. 5</p> 
<p>Pos. 6</p> 	<p>Pos. 7</p> 	<p>Pos. 8</p> 	<p>Pos. 9</p>  <hr/> <p>Pos. 10</p> 	
<p>Pos. 11</p> 	<p>Pos. 12</p> 			
<p>Pos. 13</p> 	<p>Pos. 14</p>  <hr/> <p>Pos. 15</p> 	<p>Pos. 16</p>  <hr/> <p>Pos. 17</p> 	<p>Pos. 18</p>  <hr/> <p>Pos. 19</p> 	



Das **Original**  
und Sie fahren mit Sicherheit weiter...

Pos	Bezeichnung	Bestell- nummer
1	Kugelkupplung / attache a bille / ball-shaped coupling	8802559X
2	2x Sechskantschraube kpl./ vis a'six pans compl./ hex. bolt compl.	D931.039
	2x Sicherungsmutter/ écrou de blocage/ lock nut	D980.007
3	1x Sechskantschutzkappe / capuchonde protction Hexagonal / hex. Protective cap	45832.20
	Halter f. Abreißeil/ support pour câble de d` attelage/ support f. breakaway cable	34006894
4	Faltenbalg/ accordeon/ bellows	200175.001
5	Kabelband / câble-ruban / ribbon cable	71000194
6	1x Führungslager / tube conducteur / glide tube	200452.002
	8x Sicherungsschraube kpl./ vis a'six pans compl./ hex. bolt compl.	45872.16
7	2x Schmiernippel / graisseur / labricating nipple	202164.001
	Stoßdämpfer/ amortisseur de chocs pur/ shock absorber	87003613
8	1x Sechskantschraube kpl./ vis a'six pans compl./ hex. bolt compl.	D931.036
	2x Buchse / le coussinet / bush	36018694
	1x Kreuzkopf / le renverse / crosshead	45000194
	1x Sechskantmutter/ écrou a'six pans/ hex. Nut	D934.011
	1x Federring verz./ rondelle elastique/ spring ring	D127.007
	1x Sicherungsmutter/ écrou de blocage/ lock nut	D980.004
9	Zugstange kpl. / tirant compl./ drawbar compl. Incl.	203146.001
10	Anschlagring / bague de butee / stop ring	69004394
11	Zugdeichsel geschw. / tuyau d`actionnement / traction tube	nur auf Anfrage
12	Auflagebock kpl. / support compl. / trestle compl.	98761093
13	Handbremshebel kpl./ levier de frein a main compl./ handbrake lever compl.	202682.003
14	Handgriff / la poignee / handle	200027.001
15	Abreißeil komplett/ câble de rupture d'attelage compl./ breakaway cable compl.	203202.002
16	Federspeicher kpl. / douille a ressort compl. / spring sleeve compl.	202453.001
17	Übersetzungshebel kpl./ levier de transmission compl./ transmisson lever compl.	98812993
18	1x Scheibe A19 DIN125 PA / rondelle / washer	45908.18
	1x Scheibe A13 / rondelle / washer	D125.013
	2x Scheibe A13 / rondelle / washer	200491.001
	1x Sicherungsmutter/ écrou de blocage/ lock nut	D980.004

# AUFLAUFEINRICHTUNG KHA 7,5-B

Ausführung "GF"

Pos. 1



Pos. 2



Pos. 3



Pos. 4



Pos. 5



Pos. 6



Pos. 3



Pos. 4



Pos. 5



Pos. 7



Pos. 8



Pos. 9



Das **Original**  
und Sie fahren mit Sicherheit weiter...

Pos	Bezeichnung	Bestell- nummer
1	Auflaufeinrichtung KV13HV-A "GF" mit <b>Kugelkupplung</b>	202311.105
	Auflaufeinrichtung KV13HV-A "GF" mit <b>DIN-Öse</b>	202311.101
2	Seilzug (1000/1370) / câble / bowden cable	980023.01
	Seilzug (1100/1470) / câble / bowden cable	980023.02
	Seilzug (1200/1570) / câble / bowden cable	980023.03
3	Bolzen M20x1,5 105mm / boulou / bolt	41001494
4	Federstecker 6,3x97	98708693
5	Knebel M20x1,5 kpl. / le garrot compl. / clamp handle compl.	98865993
6	Zwischenstück geschw./ la piece intercalaire/ intermediary part <b>500lg.</b>	9887179354
	Zwischenstück geschw./ la piece intercalaire/ intermediary part <b>650lg.</b>	9887179357
7	Hubeinrichtung kpl. / <b>500lg.</b>	9888239302
	Hubeinrichtung kpl. / <b>650lg.</b>	9888249302
8	Zugdeichsel geschw. / tuyau d`actionnement / traction tube	nur auf Anfrage
9	Auflagebock kpl. / support compl. / trestle compl.	98885693

# AUFLAUFEINRICHTUNG KR 7,5HV

Ausführung "KH"



Das **Original**  
und Sie fahren mit Sicherheit weiter...

Pos	Bezeichnung	Bestell- nummer
1	Kugelpkupplung / attache a bille / ball-shaped coupling	8802429X
	Zugöse DIN 45 M12/M12 / DIN anneau de couplage / DIN drawbar eye	98761693
2	2x Sechskantschraube kpl./ vis a'six pans compl./ hex. bolt compl.	D931.017
	1x Sattelscheibe 13 verz./ disque a patin 13 galv./ caliper 13 zinc-plated	43004294
	2x Sicherungsmutter/ écrou de blocage/ lock nut	D980.004
	1x Sechskantschutzkappe / capuchonde protction Hexagonal / hex. Protective cap	45832.10
3	Halter f. Abreißseil/ support pour câble de d` attelage/ support f. breakaway cable	34006894
4	Faltenbalg/ accordeon/ bellows <b>für Kugelpkupplung</b>	69004692
	Faltenbalg/ accordeon/ bellows <b>für DIN-Zugöse</b>	69000393
5	Kabelband / câble-ruban / ribbon cable	71000194
6	1x Führungsrohr / tube conducteur / glide tube	98508393
	2x Sechskantschraube kpl./ vis a'six pans compl./ hex. bolt compl.	7100599404
	2x Sechskantschraube kpl./ vis a'six pans compl./ hex. bolt compl.	D933.070
	4x Sattelscheibe 13 verz./ disque a patin 13 galv./ caliper 13 zinc-plated	43004294
7	Stoßdämpfer/ amortisseur de chocs pur/ shock absorber	87000313
8	1x Sechskantschraube kpl./ vis a'six pans compl./ hex. bolt compl.	D931.020
	2x Buchse / le coussinet / bush	36001594
	1x Kreuzkopf / le renverse / crosshead	45000194
	1x Sechskantmutter/ écrou a'six pans/ hex. Nut	D934.011
	1x Federring verz./ rondelle elastique/ spring ring	D127.007
	1x Sicherungsmutter/ écrou de blocage/ lock nut	D980.004
9	Zugstange kpl. / tirant compl./ drawbar compl. Incl. Pos. 9	98850294
10	Anschlagring / bague de butee / stop ring	69001494
11	Führungslager incl. Sicherungsstift / palier-guide / guide bearing	69005094
12	Gehäuse verz. / boiter compl. / housing zinc-plated	nur auf Anfrage
13	Abdeckhaube / capot de protection / protective cap	6902439X
	Spreizniet / rivet a expansion / expanding rivet	6902449X
14	Handbremshebel kpl./ levier de frein a main compl./ handbrake lever compl.	200334.001
15	Handgriff / la poignee / handle	200027.001
16	Abreißseil komplett/ câble de rupture d'attelage compl./ breakaway cable compl.	203202.002
17	Federhülse kpl. / douille a ressort compl. / spring sleeve compl.	98702594
18	Übersetzungshebel kpl./ levier de transmission compl./ transmisson lever compl.	98722483
19	Bolzen mit Gewindezapfen/ boulon avec goupille filet/ bolt with threaded pin	41004594
20	1x Scheibe A19 DIN125 PA / rondelle / washer	45908.18
	1x Scheibe A13 / rondelle / washer	43001494
	1x Scheibe A13 / rondelle / washer	D125.012
	1x Sicherungsmutter/ écrou de blocage/ lock nut	D980.004

# AUFLAUFEINRICHTUNG KHA 13-B

Ausführung "GF"

Pos. 1



Pos. 2



Pos. 3



Pos. 6



Pos. 8



Pos. 11



Pos. 4



Pos. 9



Pos. 5



Pos. 10



Pos. 7



Pos. 12



Pos. 13



Das **Original**  
und Sie fahren mit Sicherheit weiter...

Pos	Bezeichnung	Bestell- nummer
1	Auflaufeinrichtung KV13HV-C "GF" mit Kugelkupplung	202311.005
	Auflaufeinrichtung KV13HV-C "GF" mit DIN-Öse	202311.001
2	Seilzug (1000/1370) / câble / bowden cable	980023.01
	Seilzug (1100/1470) / câble / bowden cable	980023.02
	Seilzug (1200/1570) / câble / bowden cable	980023.03
3	Bolzen M20x1,5 105mm / boulou / bolt	41001494
4	Federstecker 6,3x97	98708693
5	Knebel M20x1,5 kpl. / le garrot compl. / clamp handle compl.	98865993
6	Zwischenstück geschw./ la piece intercalaire/ intermediary part <b>500lg.</b>	9887179354
	Zwischenstück geschw./ la piece intercalaire/ intermediary part <b>600lg.</b>	9887179356
	Zwischenstück geschw./ la piece intercalaire/ intermediary part <b>650lg.</b>	9887179357
	Zwischenstück geschw./ la piece intercalaire/ intermediary part <b>700lg.</b>	9887179358
7	Zwischenstück geschw./ la piece intercalaire/ intermediary part <b>500lg. verstärkt</b>	9887189354
	Zwischenstück geschw./ la piece intercalaire/ intermediary part <b>600lg. verstärkt</b>	9887189356
	Zwischenstück geschw./ la piece intercalaire/ intermediary part <b>650lg. verstärkt</b>	9887189357
	Zwischenstück geschw./ la piece intercalaire/ intermediary part <b>700lg. verstärkt</b>	9887189358
8	Bolzen M28x1,5 141mm / boulou / bolt	41003284
9	Knebel M28x1,5 kpl. / le garrot compl. / clamp handle compl.	98852793
10	Federstecker 7x125	98708694
11	Hubeinrichtung kpl. / <b>500lg.</b>	9888239302
	Hubeinrichtung kpl. / <b>600lg.</b>	9888249302
	Hubeinrichtung kpl. / <b>650lg.</b>	201320.001
	Hubeinrichtung kpl. / <b>700lg.</b>	9888259302
12	Zugdeichsel geschw. / tuyau d`actionnement / traction tube	nur auf Anfrage
13	Auflagebock kpl. / support compl. / trestle compl.	98885293

# AUFLAUFEINRICHTUNG KR 13HV-C

Ausführung "KH"















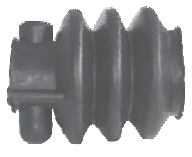

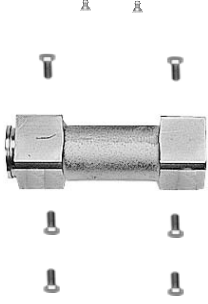



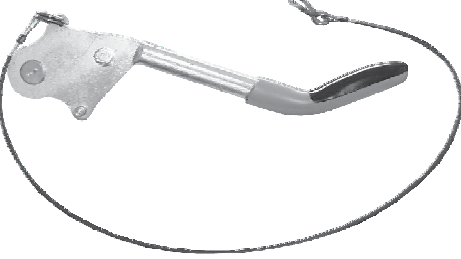

Das **Original**  
und Sie fahren mit Sicherheit weiter...

Pos	Bezeichnung	Bestell- nummer
1	Kugelpkupplung / attache a bille / ball-shaped coupling	8802429X
	Zugöse DIN 45 M12/M12 / DIN anneau de couplage / DIN drawbar eye	98761693
2	2x Sechskantschraube kpl./ vis a'six pans compl./ hex. bolt compl.	D931.017
	1x Sattelscheibe 13 verz./ disque a patin 13 galv./ caliper 13 zinc-plated	43004294
	2x Sicherungsmutter/ écrou de blocage/ lock nut	D980.004
	1x Sechskantschutzkappe / capuchonde protction Hexagonal / hex. Protective cap	45832.10
3	Halter f. Abreißseil/ support pour câble de d` attelage/ support f. breakaway cable	34006894
4	Faltenbalg/ accordeon/ bellows <b>für Kugelpkupplung</b>	69004692
	Faltenbalg/ accordeon/ bellows <b>für DIN-Zugöse</b>	69000393
5	Kabelband / câble-ruban / ribbon cable	71000194
6	1x Führungsrohr / tube conducteur / glide tube	98508393
	2x Sechskantschraube kpl./ vis a'six pans compl./ hex. bolt compl.	7100599404
	2x Sechskantschraube kpl./ vis a'six pans compl./ hex. bolt compl.	D933.070
	4x Sattelscheibe 13 verz./ disque a patin 13 galv./ caliper 13 zinc-plated	43004294
7	Stoßdämpfer/ amortisseur de chocs pur/ shock absorber	87000713
8	1x Sechskantschraube kpl./ vis a'six pans compl./ hex. bolt compl.	D931.020
	2x Buchse / le coussinet / bush	36001594
	1x Kreuzkopf / le renverse / crosshead	45000194
	1x Sechskantmutter/ écrou a'six pans/ hex. Nut	D934.011
	1x Federring verz./ rondelle elastique/ spring ring	D127.007
	1x Sicherungsmutter/ écrou de blocage/ lock nut	D980.004
9	Zugstange kpl. / tirant compl./ drawbar compl. Incl. Pos. 9	98850294
10	Anschlagring / bague de butee / stop ring	69001494
11	Führungslager incl. Sicherungsstift / palier-guide / guide bearing	69005094
12	Gehäuse verz. / boiter compl. / housing zinc-plated	nur auf Anfrage
13	Abdeckhaube / capot de protection / protective cap	6902439X
	Spreizniet / rivet a expansion / expanding rivet	6902449X
14	Handbremshebel kpl./ levier de frein a main compl./ handbrake lever compl.	200334.001
15	Handgriff / la poignee / handle	200027.001
16	Abreißseil komplett/ câble de rupture d'attelage compl./ breakaway cable compl.	203202.002
17	Federhülse kpl. / douille a ressort compl. / spring sleeve compl.	98702594
18	Übersetzungshebel kpl./ levier de transmission compl./ transmisson lever compl.	98722483
19	Bolzen mit Gewindezapfen/ boulon avec goupille filet/ bolt with threaded pin	41004594
20	1x Scheibe A19 DIN125 PA / rondelle / washer	45908.18
	1x Scheibe A13 / rondelle / washer	43001494
	1x Scheibe A13 / rondelle / washer	D125.012
	1x Sicherungsmutter/ écrou de blocage/ lock nut	D980.004

# AUFLAUFEINRICHTUNG KV 13HV-C

Ausführung "GF"

<p>Pos. 1</p> 	<p>Pos. 2</p> 	<p>Pos. 3</p> 	<p>Pos. 4</p> 	<p>Pos. 5</p> 
<p>Pos. 6</p> 	<p>Pos. 7</p> 	<p>Pos. 8</p> 	<p>Pos. 9</p>  <hr/> <p>Pos. 10</p> 	
<p>Pos. 11</p> 	<p>Pos. 12</p> 	<p>Pos. 13</p> 	<p>Pos. 14</p> 	
<p>Pos. 15</p> 	<p>Pos. 16</p> 	<p>Pos. 18</p> 	<p>Pos. 20</p> 	
<p>Pos. 17</p> 	<p>Pos. 19</p> 			

Das **Original**  
und Sie fahren mit Sicherheit weiter...

Pos	Bezeichnung	Bestell- nummer
1	Kugelpkupplung / attache a bille / ball-shaped coupling	8802429X
	Zugöse DIN 45 M12/M12 / DIN anneau de couplage / DIN drawbar eye	98761693
2	2x Sechskantschraube kpl./ vis a'six pans compl./ hex. bolt compl.	D931.017
	1x Sattelscheibe 13 verz./ disque a patin 13 galv./ caliper 13 zinc-plated	43004294
	2x Sicherungsmutter/ écrou de blocage/ lock nut	D980.004
	1x Sechskantschutzkappe / capuchonde protction Hexagonal / hex. Protective cap	45832.10
3	Halter f. Abreißseil/ support pour câble de d` attelage/ support f. breakaway cable	34006894
4	Faltenbalg/ accordeon/ bellows <b>für Kugelpkupplung</b>	69004692
	Faltenbalg/ accordeon/ bellows <b>für DIN-Zugöse</b>	69000393
5	Kabelband / câble-ruban / ribbon cable	71000194
6	1x Führungsrohr / tube conducteur / glide tube	200795.002
	4x Sechskantschraube kpl./ vis a'six pans compl./ hex. bolt compl.	45872.15
	2x Sechskantschraube kpl./ vis a'six pans compl./ hex. bolt compl.	45872.16
	2x Schmiernippel / graisseur / labricating nipple	202164.001
7	Stoßdämpfer/ amortisseur de chocs pur/ shock absorber	87000713
8	1x Sechskantschraube kpl./ vis a'six pans compl./ hex. bolt compl.	D931.019
	2x Buchse / le coussinet / bush	3601519401
	1x Kreuzkopf / le renverse / crosshead	45000194
	1x Sechskantmutter/ écrou a'six pans/ hex. Nut	D934.011
	1x Federring verz./ rondelle elastique/ spring ring	D127.007
	1x Sicherungsmutter/ écrou de blocage/ lock nut	D980.004
9	Zugstange kpl. / tirant compl./ drawbar compl. Incl. Pos. 9	98850294
10	Anschlagring / bague de butee / stop ring	69001494
11	Gehäuse verz. / boiter compl. / housing zinc-plated	nur auf Anfrage
12	Handgriff / la poignee / handle	6G0448.001
13	Kunststoffabdeckung / capot de protection / protective cap	201244.001
	Gewindefurch Schraube	D7500.001
14	Kunststoffabdeckung / capot de protection / protective cap	201243.001
15	Handbremshebel kpl./ levier de frein a main compl./ handbrake lever compl.	201939.001
16	Handgriff / la poignee / handle	200027.001
17	Abreißseil komplett/ câble de rupture d'attelage compl./ breakaway cable compl.	203202.002
18	Federspeicher kpl. / douille a ressort compl. / spring sleeve compl.	201856.001
19	Übersetzungshebel kpl./ levier de transmission compl./ transmisson lever compl.	98722483
20	2x Scheibe A19 DIN125 PA / rondelle / washer	45908.18
	1x Scheibe A13 / rondelle / washer	D125.013
	1x Sicherungsmutter/ écrou de blocage/ lock nut	D980.004

# AUFLAUFEINRICHTUNG KHA 20-B

Ausführung "GF"

Pos. 1



Pos. 2



Pos. 3



Pos. 6



Pos. 8



Pos. 11



Pos. 4



Pos. 9



Pos. 5



Pos. 10



Pos. 12



Pos. 13



Das **Original**  
und Sie fahren mit Sicherheit weiter...

Pos	Bezeichnung	Bestell- nummer
1	Auflaufeinrichtung KV20HV-A "GF" mit Kugelkupplung	202334.005
	Auflaufeinrichtung KV20HV-A "GF" mit DIN-Öse	202334.001
2	Seilzug (1000/1370) / câble / bowden cable	980023.01
	Seilzug (1100/1470) / câble / bowden cable	980023.02
	Seilzug (1200/1570) / câble / bowden cable	980023.03
3	Bolzen M20x1,5 105mm / boulou / bolt	41001494
4	Federstecker 6,3x97	98708693
5	Knebel M20x1,5 kpl. / le garrot compl. / clamp handle compl.	98865993
7	Zwischenstück geschw./ la piece intercalaire/ intermediary part <b>500lg.</b>	9888389251
	Zwischenstück geschw./ la piece intercalaire/ intermediary part <b>600lg.</b>	9888389257
	Zwischenstück geschw./ la piece intercalaire/ intermediary part <b>700lg.</b>	9888389258
8	Bolzen M28x1,5 141mm / boulou / bolt	41003284
9	Knebel M28x1,5 kpl. / le garrot compl. / clamp handle compl.	98852793
10	Federstecker 7x125	98708694
11	Hubeinrichtung kpl. / <b>500lg.</b>	9888239302
	Hubeinrichtung kpl. / <b>600lg.</b>	9888249302
	Hubeinrichtung kpl. / <b>700lg.</b>	9888259302
12	Zugdeichsel geschw. / tuyau d`actionnement / traction tube	nur auf Anfrage
13	Auflagebock kpl. / support compl. / trestle compl.	98884093

# AUFLAUFEINRICHTUNG KR 20HV-A

Ausführung "KH"

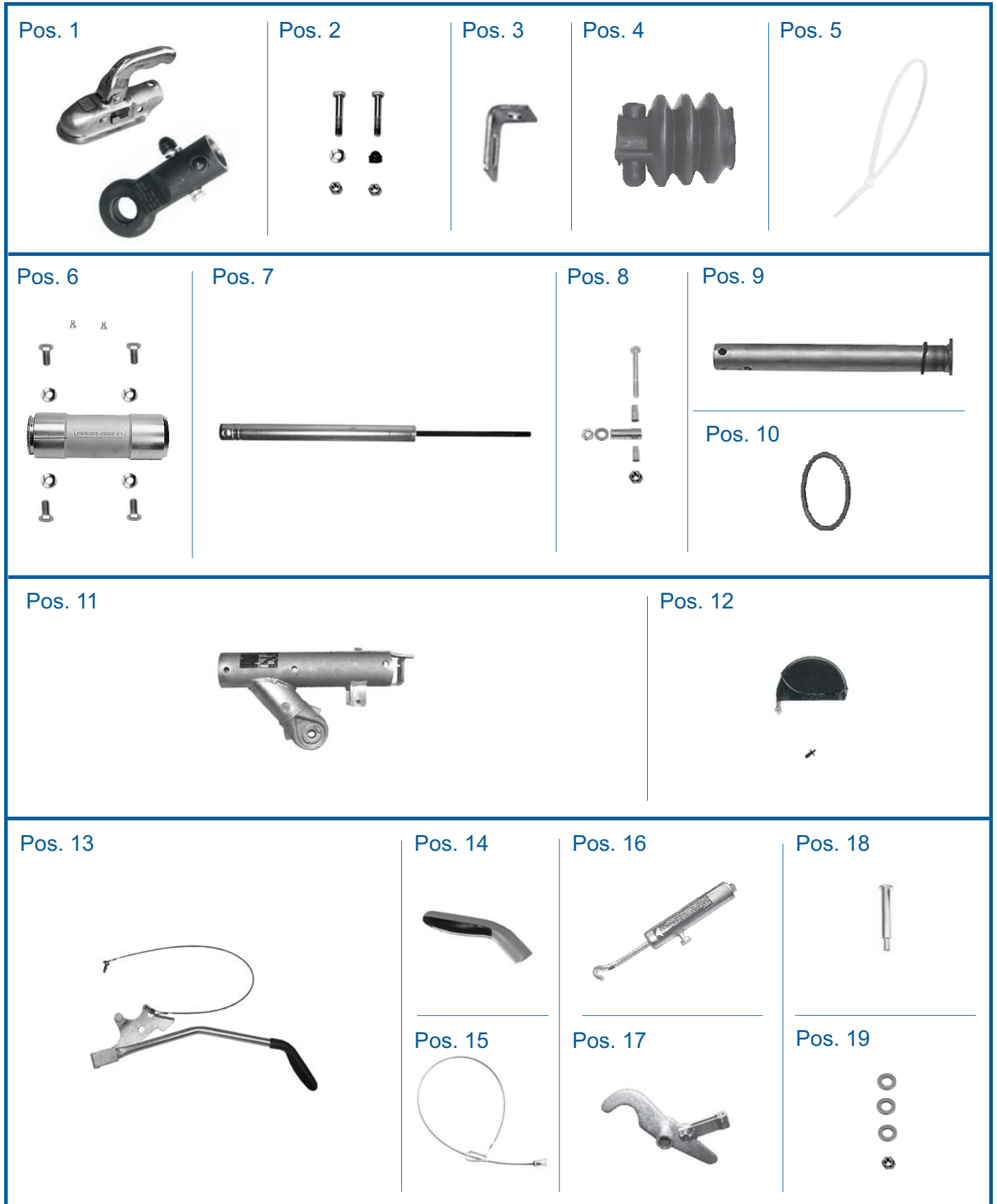

Das **Original**  
und Sie fahren mit Sicherheit weiter...

Pos	Bezeichnung	Bestell- nummer
1	Kugelpkupplung / attache a bille / ball-shaped coupling	8802399X
	Zugöse DIN 45 M12/M12 / DIN anneau de couplage / DIN drawbar eye	98761693
2	2x Sechskantschraube kpl./ vis a'six pans compl./ hex. bolt compl.	D931.017
	1x Sattelscheibe 13 verz./ disque a patin 13 galv./ caliper 13 zinc-plated	43004294
	2x Sicherungsmutter/ écrou de blocage/ lock nut	D980.004
	1x Sechskantschutzkappe / capuchonde protction Hexagonal / hex. Protective cap	45832.10
3	Halter f. Abreißseil/ support pour câble de d` attelage/ support f. breakaway cable	34006894
4	Faltenbalg/ accordeon/ bellows <b>für Kugelpkupplung</b>	69004692
	Faltenbalg/ accordeon/ bellows <b>für DIN-Zugöse</b>	69000393
5	Kabelband / câble-ruban / ribbon cable	71000194
6	1x Führungsrohr / tube conducteur / glide tube	201398.003
	4x Sechskantschraube kpl./ vis a'six pans compl./ hex. bolt compl.	7100599403
	2x Schmiernippel / graisseur / labricating nipple	48032094
	4x Sattelscheibe 13 verz./ disque a patin 13 galv./ caliper 13 zinc-plated	43004294
7	Stoßdämpfer/ amortisseur de chocs pur/ shock absorber	87001113
8	1x Sechskantschraube kpl./ vis a'six pans compl./ hex. bolt compl.	D931.020
	2x Buchse / le coussinet / bush	36001594
	1x Kreuzkopf / le renverse / crosshead	45000194
	1x Sechskantmutter/ écrou a'six pans/ hex. Nut	D934.011
	1x Federring verz./ rondelle elastique/ spring ring	D127.007
	1x Sicherungsmutter/ écrou de blocage/ lock nut	D980.004
9	Zugstange kpl. / tirant compl./ drawbar compl. Incl. Pos. 9	98850294
10	Anschlagring / bague de butee / stop ring	69001494
11	Gehäuse verz. / boiter compl. / housing zinc-plated	nur auf Anfrage
12	Abdeckhaube / capot de protection / protective cap	6902439X
	Spreizniet / rivet a expansion / expanding rivet	6902449X
13	Handbremshebel kpl./ levier de frein a main compl./ handbrake lever compl.	200334.001
14	Handgriff / la poignee / handle	200027.001
15	Abreißseil komplett/ câble de rupture d'attelage compl./ breakaway cable compl.	203202.002
16	Federhülse kpl. / douille a ressort compl. / spring sleeve compl.	98702594
17	Übersetzungshebel kpl./ levier de transmission compl./ transmisson lever compl.	98722483
18	Bolzen mit Gewindezapfen/ boulon avec goupille filet/ bolt with threaded pin	41004594
19	1x Scheibe A19 DIN125 PA / rondelle / washer	45908.18
	1x Scheibe A13 / rondelle / washer	43001494
	1x Scheibe A13 / rondelle / washer	D125.012
	1x Sicherungsmutter/ écrou de blocage/ lock nut	D980.004

# AUFLAUFEINRICHTUNG KV 20HV-A

Ausführung "GF"

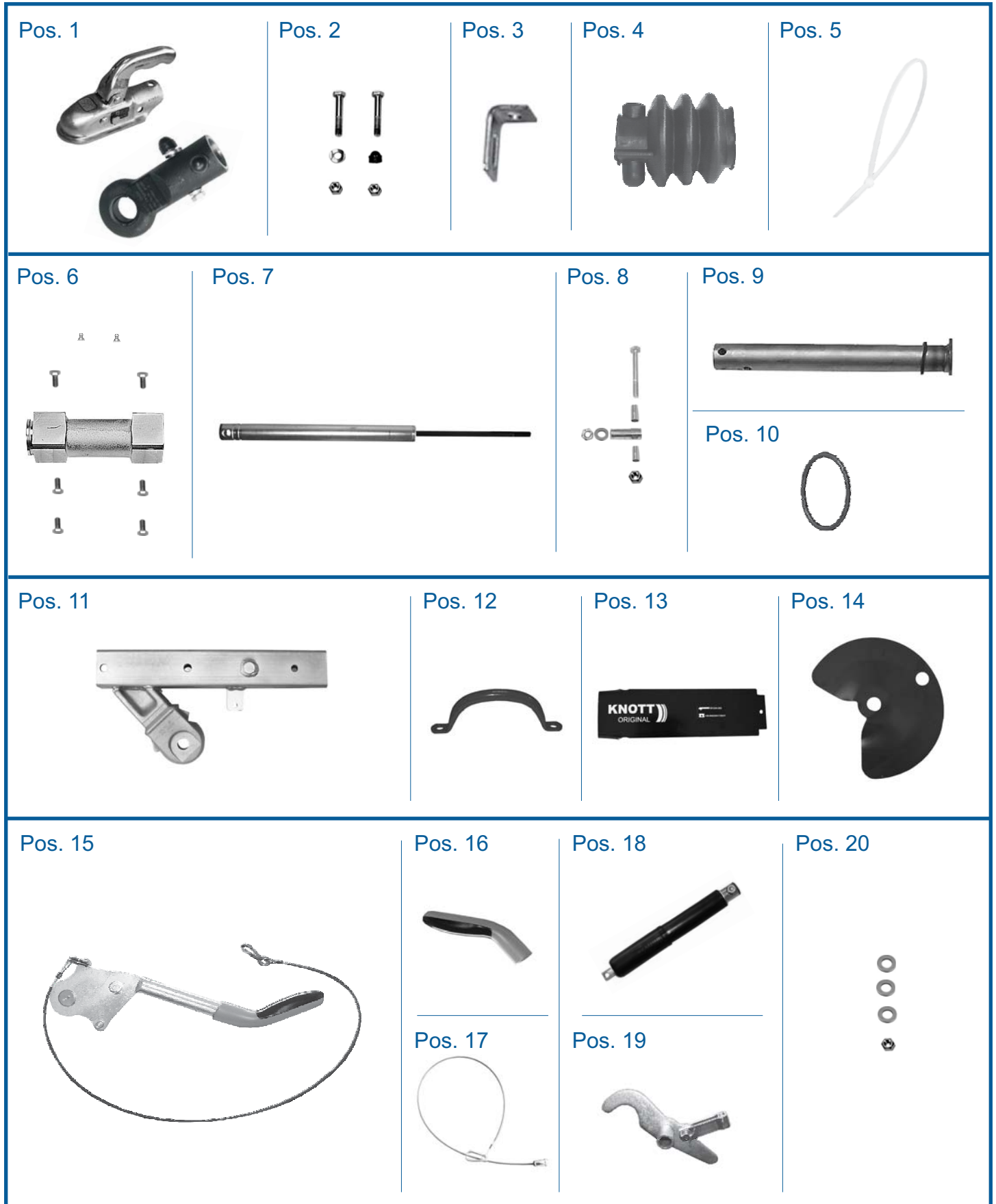



Das **Original**  
und Sie fahren mit Sicherheit weiter...

Pos	Bezeichnung	Bestell- nummer
1	Kugelpkupplung / attache a bille / ball-shaped coupling	8802399X
	Zugöse DIN 45 M12/M12 / DIN anneau de couplage / DIN drawbar eye	98761693
2	2x Sechskantschraube kpl./ vis a'six pans compl./ hex. bolt compl.	D931.017
	1x Sattelscheibe 13 verz./ disque a patin 13 galv./ caliper 13 zinc-plated	43004294
	2x Sicherungsmutter/ écrou de blocage/ lock nut	D980.004
	1x Sechskantschutzkappe / capuchonde protction Hexagonal / hex. Protective cap	45832.10
3	Halter f. Abreißeil/ support pour câble de d` attelage/ support f. breakaway cable	34006894
4	Faltenbalg/ accordeon/ bellows <b>für Kugelpkupplung</b>	69004692
	Faltenbalg/ accordeon/ bellows <b>für DIN-Zugöse</b>	69000393
5	Kabelband / câble-ruban / ribbon cable	71000194
6	1x Führungsrohr / tube conducteur / glide tube	200795.002
	4x Sechskantschraube kpl./ vis a'six pans compl./ hex. bolt compl.	45872.15
	2x Sechskantschraube kpl./ vis a'six pans compl./ hex. bolt compl.	45872.16
	2x Schmiernippel / graisseur / labricating nipple	202164.001
7	Stoßdämpfer/ amortisseur de chocs pur/ shock absorber	87001113
8	1x Sechskantschraube kpl./ vis a'six pans compl./ hex. bolt compl.	D931.019
	2x Buchse / le coussinet / bush	3601519401
	1x Kreuzkopf / le renverse / crosshead	45000194
	1x Sechskantmutter/ écrou a'six pans/ hex. Nut	D934.011
	1x Federring verz./ rondelle elastique/ spring ring	D127.007
	1x Sicherungsmutter/ écrou de blocage/ lock nut	D980.004
9	Zugstange kpl. / tirant compl./ drawbar compl. Incl. Pos. 9	98850294
10	Anschlagring / bague de butee / stop ring	69001494
11	Gehäuse verz. / boiter compl. / housing zinc-plated	nur auf Anfrage
12	Handgriff / la poignee / handle	6G0448.001
13	Kunststoffabdeckung / capot de protection / protective cap	201244.001
	Gewindefurch Schraube	D7500.001
14	Kunststoffabdeckung / capot de protection / protective cap	201243.001
15	Handbremshebel kpl./ levier de frein a main compl./ handbrake lever compl.	201939.001
16	Handgriff / la poignee / handle	200027.001
17	Abreißeil komplett/ câble de rupture d'attelage compl./ breakaway cable compl.	203202.002
18	Federspeicher kpl. / douille a ressort compl. / spring sleeve compl.	201856.001
19	Übersetzungshebel kpl./ levier de transmission compl./ transmisson lever compl.	98722483
20	2x Scheibe A19 DIN125 PA / rondelle / washer	45908.18
	1x Scheibe A13 / rondelle / washer	D125.013
	1x Sicherungsmutter/ écrou de blocage/ lock nut	D980.004

# AUFLAUFEINRICHTUNG KHA 30-A / B

Ausführung "GF"

Pos. 1

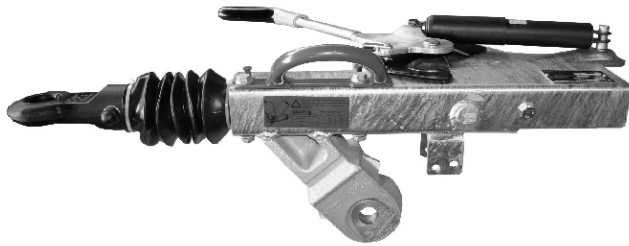

Pos. 2



Pos. 3



Pos. 6



Pos. 8



Pos. 11



Pos. 4



Pos. 9



Pos. 5



Pos. 10



Pos. 12



Pos. 13



Das **Original**  
und Sie fahren mit Sicherheit weiter...

Pos	Bezeichnung	Bestell- nummer
1	Auflaufeinrichtung KV30HV-A "GF" <b>1500-2600kg mit Kugelkupplung</b>	201895.006
	Auflaufeinrichtung KV30HV-A "GF" <b>1500-2600kg mit DIN-Öse</b>	201895.001
	Auflaufeinrichtung KV30HV-B "GF" <b>2500-3000kg mit Kugelkupplung</b>	201895.106
	Auflaufeinrichtung KV30HV-B "GF" <b>2500-3000kg mit DIN-Öse</b>	201895.101
2	Seilzug (1000/1370) / câble / bowden cable	980000.01
	Seilzug (1100/1470) / câble / bowden cable	980000.02
	Seilzug (1200/1570) / câble / bowden cable	980000.03
3	Bolzen M28x1,5 141mm / boulou / bolt	41003284
4	Federstecker 6,3x97	98708694
5	Knebel M28x1,5 kpl. / le garrot compl. / clamp handle compl.	98852793
7	Zwischenstück geschw./ la piece intercalaire/ intermediary part <b>500lg.</b>	9888389251
	Zwischenstück geschw./ la piece intercalaire/ intermediary part <b>600lg.</b>	9888389257
	Zwischenstück geschw./ la piece intercalaire/ intermediary part <b>700lg.</b>	9888389258
8	Bolzen M36x1,5 174mm / boulou / bolt	41026094
9	Knebel M36x1,5 kpl. / le garrot compl. / clamp handle compl.	98866393
10	Federstecker 7x125	98708694
11	Hubeinrichtung kpl. / <b>500lg.</b>	9888269302
	Hubeinrichtung kpl. / <b>600lg.</b>	9888279302
	Hubeinrichtung kpl. / <b>700lg.</b>	9888289302
12	Zugdeichsel geschw. / tuyau d`actionnement / traction tube	nur auf Anfrage
13	Auflagebock kpl. / support compl. / trestle compl.	98761093

# AUFLAUFEINRICHTUNG KR 30HV-A / B

Ausführung "KH"

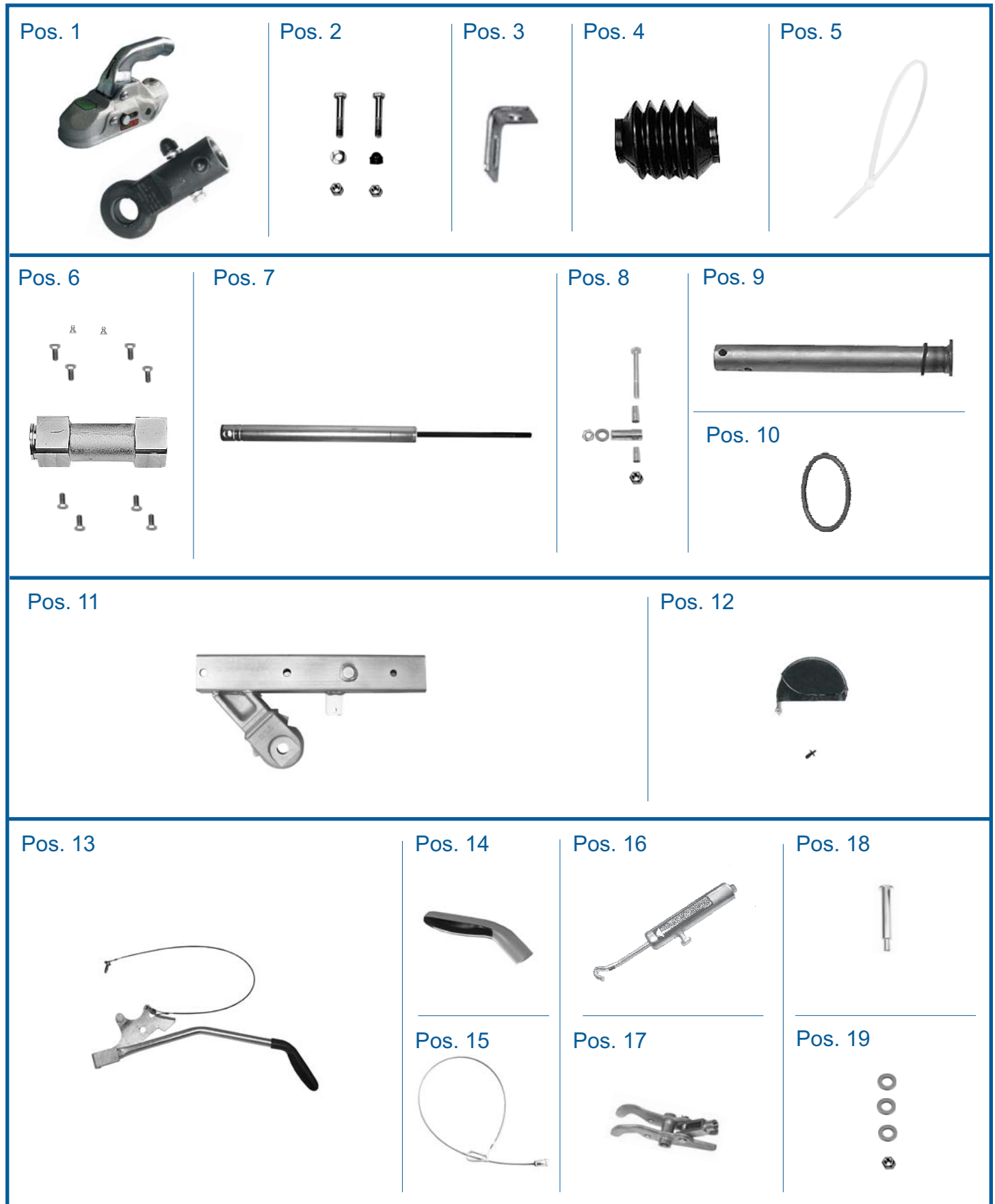

Das **Original**  
und Sie fahren mit Sicherheit weiter...

Pos	Bezeichnung	Bestell- nummer
1	Kugelkupplung / attache a bille / ball-shaped coupling	8802539X
	Zugöse DIN 50 M14/M14 / DIN anneau de couplage / DIN drawbar eye	98761993
2	1x Sechskantschraube kpl./ vis a'six pans compl./ hex. bolt compl.	D931.026
	1x Sechskantschraube kpl./ vis a'six pans compl./ hex. bolt compl.	D931.027
	1x Sattelscheibe 13 verz./ disque a patin 13 galv./ caliper 13 zinc-plated	43007794
	2x Sicherungsmutter/ écrou de blocage/ lock nut	D980.007
	1x Sechskantschutzkappe / capuchonde protction Hexagonal / hex. Protective cap	45832.20
3	Halter f. Abreißeil/ support pour câble de d` attelage/ support f. breakaway cable	34006894
4	Faltenbalg/ accordeon/ bellows	69000393
5	Kabelband / câble-ruban / ribbon cable	71000194
6	1x Führungslager/ tube conducteur / glide tube	200312.002
	6x Sechskantschraube kpl./ vis a'six pans compl./ hex. bolt compl.	45872.16
	2x Sechskantschraube kpl./ vis a'six pans compl./ hex. bolt compl.	45872.17
	2x Schmiernippel / graisseur / labricating nipple	48032094
	8x Federring verz./ rondelle elastique/ spring ring	D127.008
7	Stoßdämpfer/ amortisseur de chocs pur/ shock absorber <b>1500 - 2600kg</b>	87001313
	Stoßdämpfer/ amortisseur de chocs pur/ shock absorber <b>2500 - 3000kg</b>	87001413
8	1x Sechskantschraube kpl./ vis a'six pans compl./ hex. bolt compl.	D931.021
	2x Buchse / le coussinet / bush	36015194
	1x Kreuzkopf / le renverse / crosshead	45000194
	1x Sechskantmutter/ écrou a'six pans/ hex. Nut	D934.011
	1x Federring verz./ rondelle elastique/ spring ring	D127.007
	1x Sicherungsmutter/ écrou de blocage/ lock nut	D980.004
9	Zugstange kpl. / tirant compl./ drawbar compl. Incl. Pos. 9	98596283
10	Anschlagring / bague de butee / stop ring	69001494
11	Gehäuse verz. / boiter compl. / housing zinc-plated	nur auf Anfrage
12	Abdeckhaube / capot de protection / protective cap	6902439X
	Spreizniet / rivet a expansion / expanding rivet	6902449X
13	Handbremshebel kpl./ levier de frein a main compl./ handbrake lever compl.	200334.001
14	Handgriff / la poignée / handle	200027.001
15	Abreißeil komplett/ câble de rupture d'attelage compl./ breakaway cable compl.	203202.002
16	Federhülse kpl. / douille a ressort compl. / spring sleeve compl.	98702694
17	Übersetzungshebel kpl./ levier de transmission compl./ transmisson lever compl.	98795793
18	Bolzen mit Gewindezapfen/ boulon avec goupille file/ bolt with threaded pin	41004694
19	3x Scheibe A19 DIN125 PA / rondelle / washer	45908.18
	2x Scheibe A13 / rondelle / washer	43001494
	1x Scheibe A13 / rondelle / washer	43000794
	1x Sicherungsmutter/ écrou de blocage/ lock nut	D980.004

# AUFLAUFEINRICHTUNG KR 30HV-A/B

Ausführung "GF"

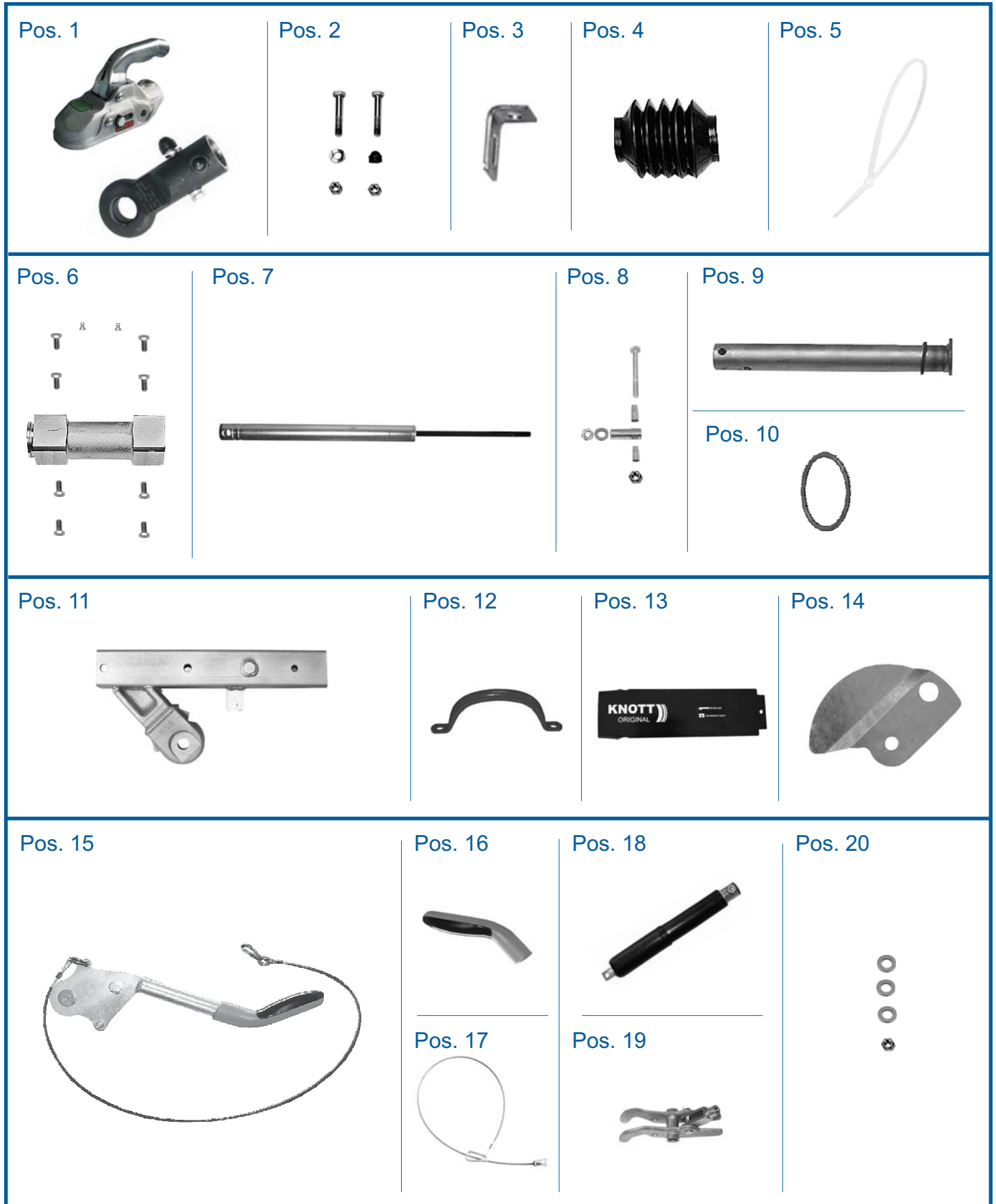

Das **Original**  
und Sie fahren mit Sicherheit weiter...

Pos	Bezeichnung	Bestell- nummer
1	Kugelkupplung / attache a bille / ball-shaped coupling	8802539X
	Zugöse DIN 50 M14/M14 / DIN anneau de couplage / DIN drawbar eye	98761993
2	1x Sechskantschraube kpl./ vis a'six pans compl./ hex. bolt compl.	D931.027
	1x Sechskantschraube kpl./ vis a'six pans compl./ hex. bolt compl.	D931.026
	1x Sattelscheibe 13 verz./ disque a patin 13 galv./ caliper 13 zinc-plated	43007794
	2x Sicherungsmutter/ écrou de blocage/ lock nut	D980.007
	1x Sechskantschutzkappe / capuchonde protction Hexagonal / hex. Protective cap	45832.20
3	Halter f. Abreißseil/ support pour câble de d` attelage/ support f. breakaway cable	34006894
4	Faltenbalg/ accordeon/ bellows	69000393
5	Kabelband / câble-ruban / ribbon cable	71000194
6	1x Führungslager / tube conducteur / glide tube	200312.002
	6x Sechskantschraube kpl./ vis a'six pans compl./ hex. bolt compl.	45872.16
	2x Sechskantschraube kpl./ vis a'six pans compl./ hex. bolt compl.	45872.17
	2x Schmiernippel / graisseur / labricating nipple	202164.001
7	Stoßdämpfer/ amortisseur de chocs pur/ shock absorber <b>Ausf. "A" 1500-2600kg</b>	87001313
	Stoßdämpfer/ amortisseur de chocs pur/ shock absorber <b>Ausf. "B" 2500-3000kg</b>	87001413
8	1x Sechskantschraube kpl./ vis a'six pans compl./ hex. bolt compl.	D931.021
	2x Buchse / le coussinet / bush	36015194
	1x Kreuzkopf / le renverse / crosshead	45000194
	1x Sechskantmutter/ écrou a'six pans/ hex. Nut	D934.011
	1x Federring verz./ rondelle elastique/ spring ring	D127.007
	1x Sicherungsmutter/ écrou de blocage/ lock nut	D980.004
9	Zugstange kpl. / tirant compl./ drawbar compl. Incl. Pos. 9	98596283
10	Anschlagring / bague de butee / stop ring	69001494
11	Gehäuse verz. / boiter compl. / housing zinc-plated	nur auf Anfrage
12	Handgriff / la poignee / handle	4300739302
13	Kunststoffabdeckung / capot de protection / protective cap	201244.002
	Gewindefurch Schraube	D7500.001
14	Blechabdeckung / capot de protection / protective cap	202168.001
15	Handbremshebel kpl./ levier de frein a main compl./ handbrake lever compl.	201137.001
16	Handgriff / la poignee / handle	200027.001
17	Abreißseil komplett/ câble de rupture d'attelage compl./ breakaway cable compl.	203202.002
18	Federspeicher kpl. / douille a ressort compl. / spring sleeve compl.	202086.001
19	Übersetzungshebel kpl./ levier de transmission compl./ transmisson lever compl.	203687.001
20	1x Scheibe A19 DIN125 PA / rondelle / washer	43001494
	1x Scheibe A13 / rondelle / washer	D125.013
	1x Scheibe A13 / rondelle / washer	D125.012
	1x Sicherungsmutter/ écrou de blocage/ lock nut	D980.004

# AUFLAUFEINRICHTUNG KHA 35-B

Ausführung "GF"

Pos. 1

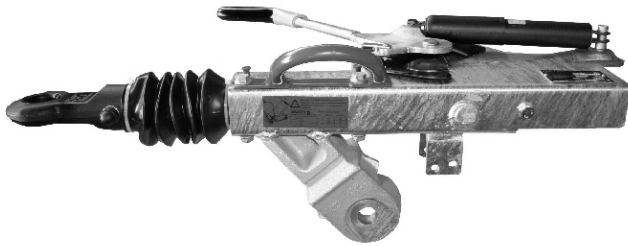

Pos. 2



Pos. 3



Pos. 6



Pos. 8



Pos. 11



Pos. 4



Pos. 9



Pos. 5



Pos. 10



Pos. 12

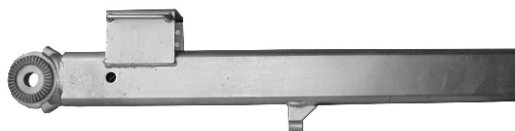

Pos. 13





Das **Original**  
und Sie fahren mit Sicherheit weiter...

Pos	Bezeichnung	Bestell- nummer
1	Auflaufeinrichtung KR35HV-B "GF" <b>2700-3500kg mit Kugelkupplung</b>	202259.004
	Auflaufeinrichtung KR35HV-B "GF" <b>2700-3500kg mit DIN-Öse</b>	202259.001
2	Seilzug (1000/1370) / câble / bowden cable	980000.01
	Seilzug (1100/1470) / câble / bowden cable	980000.02
	Seilzug (1200/1570) / câble / bowden cable	980000.03
3	Bolzen M28x1,5 141mm / boulou / bolt	41003284
4	Federstecker 6,3x97	98708694
5	Knebel M28x1,5 kpl. / le garrot compl. / clamp handle compl.	98852793
7	Zwischenstück geschw./ la piece intercalaire/ intermediary part <b>500lg.</b>	9887659252
	Zwischenstück geschw./ la piece intercalaire/ intermediary part <b>700lg.</b>	98836093
8	Bolzen M36x1,5 174mm / boulou / bolt	41026094
9	Knebel M36x1,5 kpl. / le garrot compl. / clamp handle compl.	98866393
10	Federstecker 7x125	98708694
11	Hubeinrichtung kpl. / <b>500lg.</b>	9888299302
	Hubeinrichtung kpl. / <b>700lg.</b>	9888319302
12	Zugdeichsel geschw. / tuyau d`actionnement / traction tube	nur auf Anfrage
13	Auflagebock kpl. / support compl. / trestle compl. <b>100x100</b>	98761093
	Auflagebock kpl. / support compl. / trestle compl. <b>160x 90</b>	98794993

# AUFLAUFEINRICHTUNG KR 35HV-B

Ausführung "KH"

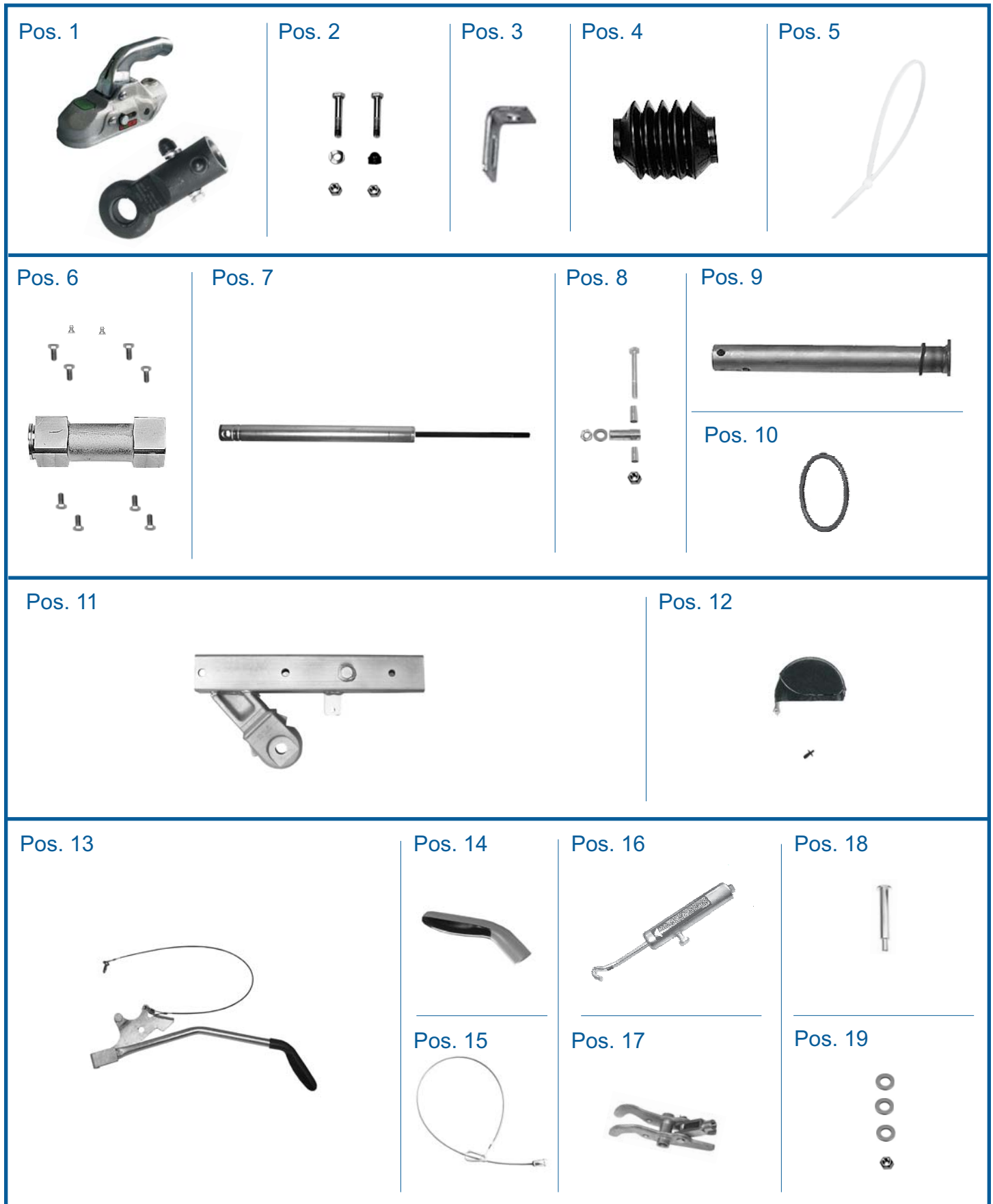













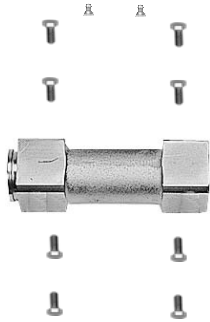





Das **Original**  
und Sie fahren mit Sicherheit weiter...

Pos	Bezeichnung	Bestell- nummer
1	Kugelumkupplung / attache a bille / ball-shaped coupling	8802559X
	Zugöse DIN 60 M14/M14 / DIN anneau de couplage / DIN drawbar eye	98762093
2	2x Sechskantschraube kpl./ vis a'six pans compl./ hex. bolt compl.	D931.039
	2x Sicherungsmutter/ écrou de blocage/ lock nut	D980.007
	1x Sechskantschutzkappe / capuchonde protction Hexagonal / hex. Protective cap	45832.20
3	Halter f. Abreißeil/ support pour câble de d` attelage/ support f. breakaway cable	34006894
4	Faltenbalg/ accordeon/ bellows	200175.001
5	Kabelband / câble-ruban / ribbon cable	71000194
6	1x Führungslager/ tube conducteur / glide tube	200452.002
	6x Sechskantschraube kpl./ vis a'six pans compl./ hex. bolt compl.	45872.16
	2x Sechskantschraube kpl./ vis a'six pans compl./ hex. bolt compl.	45872.17
	2x Schmiernippel / graisseur / labricating nipple	202164.001
	8x Federring verz./ rondelle elastique/ spring ring	D127.008
7	Stoßdämpfer/ amortisseur de chocs pur/ shock absorber <b>2500 - 3000kg</b>	87003613
8	1x Sechskantschraube kpl./ vis a'six pans compl./ hex. bolt compl.	D931.036
	2x Buchse / le coussinet / bush	36015194
	1x Kreuzkopf / le renverse / crosshead	45000194
	1x Sechskantmutter/ écrou a'six pans/ hex. Nut	D934.011
	1x Federring verz./ rondelle elastique/ spring ring	D127.007
	1x Sicherungsmutter/ écrou de blocage/ lock nut	D980.004
9	Zugstange kpl. / tirant compl./ drawbar compl. Incl. Pos. 9	203146.001
10	Anschlagring / bague de butee / stop ring	69004394
11	Gehäuse verz. / boiter compl. / housing zinc-plated	nur auf Anfrage
12	Abdeckhaube / capot de protection / protective cap	6902439X
	Spreizniet / rivet a expansion / expanding rivet	6902449X
13	Handbremshebel kpl./ levier de frein a main compl./ handbrake lever compl.	200334.002
14	Handgriff / la poignee / handle	200027.001
15	Abreißeil komplett/ câble de rupture d'attelage compl./ breakaway cable compl.	203202.002
16	Federhülse kpl. / douille a ressort compl. / spring sleeve compl.	98702694
17	Übersetzungshebel kpl./ levier de transmission compl./ transmission lever compl.	98795793
18	Bolzen mit Gewindezapfen/ boulon avec goupille filet/ bolt with threaded pin	41021994
19	3x Scheibe A19 DIN125 PA / rondelle / washer	45908.18
	2x Scheibe A13 / rondelle / washer	43001494
	1x Scheibe A13 / rondelle / washer	D125.013
	1x Sicherungsmutter/ écrou de blocage/ lock nut	D980.004

# AUFLAUFEINRICHTUNG KR 35HV-B

Ausführung "GF"

<p>Pos. 1</p> 	<p>Pos. 2</p> 	<p>Pos. 3</p> 	<p>Pos. 4</p> 	<p>Pos. 5</p> 
<p>Pos. 6</p> 	<p>Pos. 7</p> 	<p>Pos. 8</p> 	<p>Pos. 9</p>  <hr/> <p>Pos. 10</p> 	
<p>Pos. 11</p> 	<p>Pos. 12</p> 	<p>Pos. 13</p> 	<p>Pos. 14</p> 	
<p>Pos. 15</p> 	<p>Pos. 16</p>  <hr/> <p>Pos. 17</p> 	<p>Pos. 18</p>  <hr/> <p>Pos. 19</p> 	<p>Pos. 20</p> 	

Das **Original**  
und Sie fahren mit Sicherheit weiter...

Pos	Bezeichnung	Bestell- nummer
1	Kugelumkupplung / attache a bille / ball-shaped coupling	8802559X
	Zugöse DIN 60 M14/M14 / DIN anneau de couplage / DIN drawbar eye	98762093
2	2x Sechskantschraube kpl./ vis a'six pans compl./ hex. bolt compl.	D931.039
	2x Sicherungsmutter/ écrou de blocage/ lock nut	D980.007
	2x Sechskantschutzkappe / capuchonde protction Hexagonal / hex. Protective cap	45832.20
3	Halter f. Abreißseil/ support pour câble de d` attelage/ support f. breakaway cable	34006894
4	Faltenbalg/ accordeon/ bellows	200175.001
5	Kabelband / câble-ruban / ribbon cable	71000194
6	1x Führungslager / tube conducteur / glide tube	200452.002
	6x Sechskantschraube kpl./ vis a'six pans compl./ hex. bolt compl.	45872.16
	2x Sechskantschraube kpl./ vis a'six pans compl./ hex. bolt compl.	45872.17
	2x Schmiernippel / graisseur / labricating nipple	202164.001
7	Stoßdämpfer/ amortisseur de chocs pur/ shock absorber	87003613
8	1x Sechskantschraube kpl./ vis a'six pans compl./ hex. bolt compl.	D931.036
	2x Buchse / le coussinet / bush	36018694
	1x Kreuzkopf / le renverse / crosshead	45000194
	1x Sechskantmutter/ écrou a'six pans/ hex. Nut	D934.011
	1x Federring verz./ rondelle elastique/ spring ring	D127.007
	1x Sicherungsmutter/ écrou de blocage/ lock nut	D980.004
9	Zugstange kpl. / tirant compl./ drawbar compl. Incl. Pos. 9	203146.001
10	Anschlagring / bague de butee / stop ring	69004394
11	Gehäuse verz. / boiter compl. / housing zinc-plated	nur auf Anfrage
12	Handgriff / la poignee / handle	4300739302
13	Kunststoffabdeckung / capot de protection / protective cap	201244.003
	Gewindefurch Schraube	D7500.001
14	Blechabdeckung / capot de protection / protective cap	202168.001
15	Handbremshebel kpl./ levier de frein a main compl./ handbrake lever compl.	201137.002
16	Handgriff / la poignee / handle	200027.001
17	Abreißseil komplett/ câble de rupture d'attelage compl./ breakaway cable compl.	203202.002
18	Federspeicher kpl. / douille a ressort compl. / spring sleeve compl.	202086.001
19	Übersetzungshebel kpl./ levier de transmission compl./ transmisson lever compl.	203687.001
20	1x Scheibe A19 DIN125 PA / rondelle / washer	43000794
	1x Scheibe A13 / rondelle / washer	D125.013
	1x Scheibe A13 / rondelle / washer	45908.18
	1x Sicherungsmutter/ écrou de blocage/ lock nut	D980.004